

India's Electricity Transition Pathways to 2050: Scenarios and Insights



India's Electricity Transition Pathways to 2050: Scenarios and Insights

Disclaimer:

This report is an output of research and analysis undertaken by TERI. While every effort has been made to avoid any errors or omissions, TERI would not be in any way liable to any persons/organizations by reason for any error or omission in the publication.

Authors

Neshwin Rodrigues*, A.K Saxena, Senior Fellow & Senior Director, TERI, Shubham Thakare*, Raghav Pachouri*, G. Renjith*

* formerly at TERI

Reviewers

K. Ramanathan, Distinguished Fellow, Electricity and Renewables Division, TERI

Ajay Shankar, Distinguished Fellow, TERI

Lord Adair Turner, Chair, Energy Transitions Commission (ETC)

Thomas Spencer, Power Sector Modeller, IEA

Narayankumar Sreekumar, Associate Director- Electric Mobility Program, Shakti Sustainable Energy Foundation

Suggested Format for Citation

Neshwin Rodrigues, A.K. Saxena, Shubham Thakare, Raghav Pachouri, and G. Renjith, (2023), "India's Electricity Transition Pathways to 2050: Scenarios and Insights", TERI Report (New Delhi: The Energy and Resources Institute).

For more information

TERI Press
The Energy and Resources Institute
Darbari Seth Block
IHC Complex,
Lodhi Road New Delhi-110 003
India

Tel. 2468 2100 or 2468 2111
E-mail pmc@teri.res.in
Fax 2468 2144 or 2468 2145
Web www.teriin.org
India +91 • Delhi (0)11

Foreword

Energy transition is at the core of restricting global climate change and achieving sustainable development. The difference between a gradual and rapid transition will eventually determine the climate future of India. During the last decade, there has been a steep decline in the costs of renewables (solar and wind) and energy storage technologies (BESS), which helped India in reaching a significant milestone of 125 GW renewable capacity in 2021.

The power sector in India contributes ~50% of the fuel-related emissions. The challenge to India's power sector is unprecedented and focusing on the sustainability considerations, climate change concerns need to be duly kept in mind. Assessing India's electricity pathways to mid-century is vital while tackling these substantial challenges.

According to this study, India is expected to witness a fourfold growth in electricity demand and new investments of the order USD 1.2 to 1.6 trillion by mid-century indicating the gradient of investments and change in demand. Investments in efficient generation technologies, scaling up transmission infrastructure and energy storage will underpin India's clean energy transition trajectory. Further, a comprehensive assessment of renewable energy potential and associated land availability needs close attention as demand electrifies rapidly.

The report examines the power system flexibility with high penetration of renewables, providing insights into technical and operating interventions. In line with India's announcements at COP26, No Fossil-fuel Scenario (NFS) of the study suggests that with coal phasing down after 2030, battery storage capacity with a longer duration would aid in balancing daily and seasonal intermittency with support from pumped hydro storage. The increasing penetration of renewables, batteries and EVs create an even more challenging context in system planning. Power sector planning now needs a holistic approach across the centre and state to coordinate multiple stakeholders while ensuring India's energy security and affordable energy price.

It is now time to include longer time horizon in the planning to inform us about the actions we take or we plan to take in the medium term and create a sustainable energy future. I am sure that this report will go a long way to provide insights to policy makers, researchers and stakeholders involved across the ecosystem.

Dr. Vibha Dhawan

Director General, TERI

Preface

The study of electricity transition pathways is essential for informed decision-making and effective policy intervention at critical junctures, encompassing both the near-term and long-term horizon. Exploring near-term and medium-term pathways is more manageable due to reduced uncertainty compared to the long-term alternatives. Long-term pathways, particularly those investigating a mid-century time horizon, offer invaluable insights for both short-term and long-term planning.

The salient features of the study carried out by TERI are as under:

- » The scope of the study includes investigating mid-century transition pathways for multiple future scenarios addressing uncertainties on both the demand and supply sides.
- » Two electricity demand scenarios are examined-- Baseline and Low Carbon scenario. These scenarios explored efficiency improvements across various sectors and electrification in areas such as transportation, hydrogen production, and cooking.
- » Three supply scenarios for 2050 are explored to understand the impact of factors such as on-shore and solar PV resource potential, policy interventions shaping the role of coal-based generation in the mid-century transition pathways, and the influence of cost trajectories for solar, wind, and energy storage.
- » The report focuses on identifying the least-cost pathway for different scenarios, analyzing how the most economically efficient option evolves with changing influencing factors across the scenarios.
- » The report acknowledges that it may not necessarily represent the most recent policy decisions regarding pumped hydro, battery storage, and coal and coal production/capacity addition, and might not incorporate the changes in the demand profile in the recent years. However, it aims to emphasize the significance of understanding how variations in different factors impact the least-cost pathway.
- » The report also offers insights into potential challenges that India may encounter concerning flexibility, investment requirements, and land availability if it chooses to pursue deep decarbonization pathways.

It is almost certain that renewables – and in particular solar and batteries – will provide cheaper electricity than fossil fuels at the total system level well before 2050. The more the fossil fuel generation in 2050, the higher the cost that the consumers will pay for electricity.

However, the present estimates of the RE resource potential, by NISE and NIWE, suggest that India cannot produce all of its projected ~5000 TWh of electricity demand by 2050 from wind and solar alone. With the government's plans underway for nuclear energy expansion, the technology holds potential for ensuring long-term, sustainable energy security.

The crucial next step is to assess whether these limitations truly exist and work towards the following:

- » If the limitations do not exist, we should adopt a confident strategy to build an electricity system by 2050 based almost entirely on renewables and using almost no fossil fuels.
- » If the limitations do exist, we must recognize that other technologies – such as nuclear and CCS – will be needed in addition to massive RE deployment to deliver the electricity supply required to meet its rising demands.

Table of Contents

List of Abbreviations	xiii
Executive Summary	1
1. Introduction	9
2. Modelling Description and Assumptions	11
2.1 Modelling Framework	12
2.2 Additional Functionality Developed	12
2.2.1 Myopic Optimization for Capacity Expansion	12
2.2.2 Clustering of Generators	13
2.2.3 Retirement of Generators	14
2.2.4 Reserve Requirement	14
2.2.5 Pumped Hydro Storage	15
2.2.6 Battery Energy Storage	16
2.3 Spatial and Time Scale Granularity	16
2.3.1 Spatial Granularity	16
2.3.2 Time-scale Selection	17
2.4 Renewable Resource Potential and Generation Profile	17
2.5 Technology Cost	17
2.5.1 Investment Cost for Various Supply-side Options	18
2.5.2 Fuel Cost, Operation and Maintenance Cost, and Discount Rate	20
2.6 Transmission Network and Cost Assumption	21
2.7 Technology Operating Parameters	22
3. Electricity Demand and Load Forecasting	23
3.1 Electricity Demand	24
3.2 Demand Projection Methodology and Key Assumptions	24
3.2.1 Residential Sector	25
3.2.2 Service Sector	29

3.2.3	Industrial Sector	31
3.2.4	Agricultural Sector	33
3.2.5	Transport Sector	35
3.2.6	Hydrogen	40
3.3	Total Demand Projections	41
4.	Technology-specific Constraints	43
4.1	Technology-specific Constraints for Capacity Expansion	44
4.2	Technology-specific Constraints for Electricity Generation	45
5.	Capacity Scenarios	47
5.1	Constrained RE Scenario (CRES): Least Cost Optimal Capacity with bounds on RE Potential	48
5.2	Unconstrained RE Scenario (URES): Least Cost Optimal Capacity without Bounds on RE Potential	48
5.3	No Fossil-fuel Scenario (NFS)	49
5.4	Sensitivities	49
6.	Results of the Study	51
6.1	Installed Capacities	53
6.2	Generation Shares and CO ₂ Emissions	59
6.3	Despatch Stacks	62
6.4	CUF and RE Curtailment	63
6.5	Investment Requirements	68
6.6	System Cost	69
6.7	Reserve Requirement	69
6.8	Transmission Build-up and Inter-regional Power Flow	71
7.	Insights from the Scenario Sensitivities	75
8.	Areas of Further Research and Model Improvement	79
9.	Conclusions	83

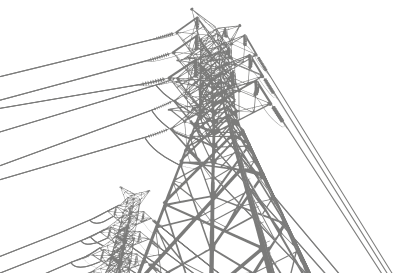

List of Figures

Figure E1:	Grid electricity demand (ex-bus)	2
Figure E2:	System cost across scenarios in 2050	3
Figure E3:	Capacity mix and grid emission factor in 2050	4
Figure E4:	Battery size requirement	5
Figure E5:	Investment required till 2050	6
Figure 1:	Schematic of typical days selected for optimization	13
Figure 2:	Characteristics of clustered generators	14
Figure 3:	Representation of Pumped Hydro storage in model	15
Figure 4:	Representation of Battery Storage in Model	16
Figure 5:	Hourly capital cost for battery energy storage system	19
Figure B-1:	Levelized Cost of Electricity (LCOE) of various technologies in years 2020, 2030, and 2050	20
Figure 6:	Projection of stock composition in residential electricity demand 2050	28
Figure 7:	Projection of commercial floor space area and assumption of weighted average EPI for AC floor space and non-AC floor space in baseline scenario to 2050	29
Figure 8:	Summary of service sector demand analysis and projections	30
Figure 9:	Results of material demand projection from key energy-intensive industries	31
Figure 10:	Historic captive consumption trend analysis	32
Figure 11:	Historic trends in the share of agriculture GVA in total GDP for the different country is categorized based on income levels	34
Figure 12:	Country-wise comparison of cars and two wheelers per thousand population as of 2016	35
Figure 13:	Scenario for new energy vehicle penetration in yearly vehicle sales	38
Figure 14:	Projection results for passenger and freight activity demand to 2050	39
Figure 15:	Results of total transport energy demand under Low Carbon and Baseline scenario	39
Figure 16:	Cost reduction potential of various hydrogen production pathways and hydrogen demand estimated based on production source	40
Figure 17:	Summary results of total grid electricity requirement	41

Figure 18:	Annual demand curves for 2019 and 2050 baseline scenario (demand in MW)	42
Figure 19:	Demand and capacity scenario architecture	48
Figure 20:	Technology-wise installed capacity by 2050	53
Figure 21:	Technology-wise capacity share in total capacity mix	53
Figure 22:	Regional solar capacities (MW) in CRES, URES, NFS in 2050	54
Figure 23:	Regional wind capacity (MW) in CRES, URES, NFS in the year 2050	55
Figure 24:	Addition and retirement of coal power plants in scenarios	56
Figure 25:	Battery system capacities across scenarios	57
Figure 26:	BESS charging and discharging profile (a) 2030, (b) 2050	58
Figure 27:	BESS charging and discharging duration curve	59
Figure 28:	Generation share % of various sources and grid emission factor (kgCO ₂ /kWh) across scenarios	60
Figure 29:	Technology contribution in peak demand in URES and NFS	61
Figure 30:	Generation by time slice in GWh	61
Figure 31:	Peak demand day despatch stack for CRES, URES, and NFS	62
Figure 32:	Despatch during (a) Low wind generation, (b) Minimum coal generation day, (c) Highest Coal Generation day in URES	63
Figure 33:	Coal despatch duration comparison in CRES and URES	65
Figure 34:	CUF (%) of coal pithead and non-pithead units	66
Figure 35:	Percentage of units running amongst non-pithead coal power plants in URES	67
Figure 36:	Percentage of units running amongst pithead coal power plants in URES	67
Figure 37:	Temporal distribution status of non-pithead units running in URES in 2050	68
Figure 38:	System cost (Rs/MWh) across scenarios	69
Figure 39:	Reserve requirement at each time instance	70
Figure 40:	Inter-regional transmission capacity requirement in 2050 with respect to the current capacity	72
Figure 41:	Power flow between regions in 2050	73
Figure 42:	Battery pack cost assumptions across the scenarios	77
Figure 43:	Installed capacity for solar PV, wind, and BESS in the year 2050 for URES and BESS sensitivity scenario	78



List of Tables

Table 1: Cost of providing reserve margin and its capacity contribution	15
Table 2: Capital cost and lifetime assumption for various technologies base year 2020	18
Table 3: Cost assumption for new transmission built-up	22
Table 4: Operational constraints considered	22
Table 5: Macro-economic drivers	25
Table 6: Residential appliances and their stock projections (in million)	26
Table 7: Assumptions on annual energy consumption of residential appliances (in kWh per year)	27
Table 8: Electric cookstove penetration.	27
Table 9: Summary of residential sector demand analysis and projection	28
Table 10: Summary of industry sector demand analysis and projections	33
Table 11: Summary of agriculture sectoral demand analysis and projections	34
Table 12: Assumptions on vehicle operating parameters (in kWh/100 km)	36
Table 13: Summary of transport sector demand analysis and projections	40
Table 14: Region-wise solar PV and wind potential (in MW) in India considered in the study	44
Table 15: Scenario description on RE potential and fossil-based capacity limit	49
Table 16: Summary of aggregate capacity, generation, and grid emission intensity in CRES, URES, and NFS	52
Table 17: CUF of technologies in the study	64
Table 18: Solar and wind curtailment	64
Table 19: Investment for capacity addition in various scenarios	68
Table 20: Comparison of installed capacity (GW) across the scenario sensitivities and URES	76

List of Abbreviations

AEEE	Alliance for an Energy Efficient Economy
AGL	Above Ground Level
APM	Administered Price Mechanism
BEE	Bureau of Energy Efficiency
BESS	Battery Energy Storage System
BEV	Battery Electric Vehicle
BNEF	Bloomberg New Energy Finance
BOS	Balance Of System
CAGR	Compound Annual Growth Rate
CAPEX	Capital Expenditure
CBET	Cross Border Electricity Trade
CCGT	Combined Cycle Gas Turbine
CEA	Central Electricity Authority
CERC	Central Electricity Regulatory Commission
CRES	Constrained RE Scenario
CUF	Capacity Utilization Factor
EPI	Environmental Performance Index
EPS	Electric Power Survey
ER	Eastern Region
EV	Electric Vehicle
FCEV	Fuel Cell Electric Vehicle
FOM	Fixed Operation and Maintenance
GAIL	Gas Authority of India Limited
GCV	Gross Calorific Value
GDP	Gross Domestic Product
GVA	Gross Value Added
HDV	Heavy Duty Vehicle
ICAP	India Cooling Action Plan
ICE	Internal Combustion Engine

IoT	Internet of Things
LBNL	Lawrence Berkeley National Laboratory
LCOE	Levelized Cost of Energy
LDV	Light Duty Vehicle
LED	Light-Emitting Diode
LNG	Liquefied Natural Gas
LPG	Liquefied Petroleum Gas
LWR	Light Water Reactor
MGA	Modelling to Generate Alternatives
MNRE	Ministry of New and Renewable Energy
MoRTH	Ministry of Road Transport & Highways
MSME	Ministry of Micro, Small & Medium Enterprises
NCAP	National Cooling Action Plan
NCAP	National Clean Air Programme
NFS	No Fossil-fuel Scenario
NGV	Natural Gas for Vehicles
NIWE	National Institute of Wind Energy
NR	Northern Region
NREL	National Renewable Energy Laboratory
O&M	Operation and Maintenance
OECD	Organisation for Economic Co-operation and Development
OSOWOG	One Sun, One World, One Grid
PCE	Pollution Control Equipment
PHWR	Pressurized Heavy Water Reactor
PLF	Plant Load Factor
PM-KUSUM	Pradhan Mantri Kisan Urja Suraksha evam Utthaan Mahabhiyan
POSOCO	Power System Operation Corporation Limited
PPA	Power Purchase Agreement
PPP	Purchasing Power Parity
PSO-CP	Power System Operation and Capacity Planning
PyPSA	Python for Power System Analysis
RAC	Residential Air Conditioning

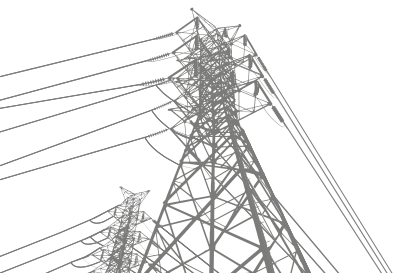

RBI	Reserve Bank of India
RE	Renewable Energy
ReEDS	Regional Energy Deployment System
RMI	Rocky Mountain Institute
ROM	Run Of Mine
RoR	Run-of-River
SIL	Surge Impedance Loading
SLM	Straight Line Method
SR	Southern Region
T&D	Transmission and Distribution
TCO	Total Cost of Ownership
TERI	The Energy and Resources Institute
UJALA	Unnat Jyoti by Affordable LEDs for All
UN	United Nations
URES	Unconstrained RE Scenario
VRE	Variable Renewable Energy
W2E	Waste to Energy
WACC	Weighted Average Cost of Capital
WR	Western Region

Executive Summary



Electricity transition is underway in India. The near-term and medium-term pathways up to 2030 having been studied, the study of mid-century pathways is extremely important to form optimal choices, even in the medium-term. The present study is an attempt in this direction.

The study considers two electricity demand scenarios-Baseline and Low Carbon Scenario, and three supply scenarios- constrained RE scenario (CRES), unconstrained RE scenario (URES), and no fossil-fuel scenario (NFS), for 2050. These scenarios were developed to explore various aspects of the electricity transition in the Indian power sector in the long-term. A description of the modelling framework is presented in section 2 of the report.

The two demand scenarios consider moderate/high efficiency improvement in appliances, processes, and penetration of electric vehicles and electric cooking.

The supply scenarios are based on the co-optimization of investment and operation costs under multiple supply-side assumptions and constraints on the operation and build-up of different power system assets. In the CRES, the renewable energy (RE) capacity build-up was restricted to the RE potential of 748 GW of solar PV and 695 GW of wind estimated by the National Institute of Solar Energy (NISE) and National Institute of Wind Energy (NIWE), respectively. In the URES, these constraints are relaxed to estimate RE build-up required in the least-cost scenario. A stylized scenario - NFS, where no new coal- and gas-based capacity build-up is considered beyond 2025, is also developed.

The major findings of model simulation for various scenarios are discussed below:

1. On-grid electricity demand is expected to increase fourfold between 2019 and 2050

Long-term demand estimation is characterized by uncertainty; Covid-19 increased the same. Therefore, 'plausible' electricity demand scenarios were developed using econometric and end-use approaches for the key consumer sectors. This was done considering the relationship with macro-economic variables, past trends, end-use efficiency improvement potential, consumer load shifting potential, and penetration

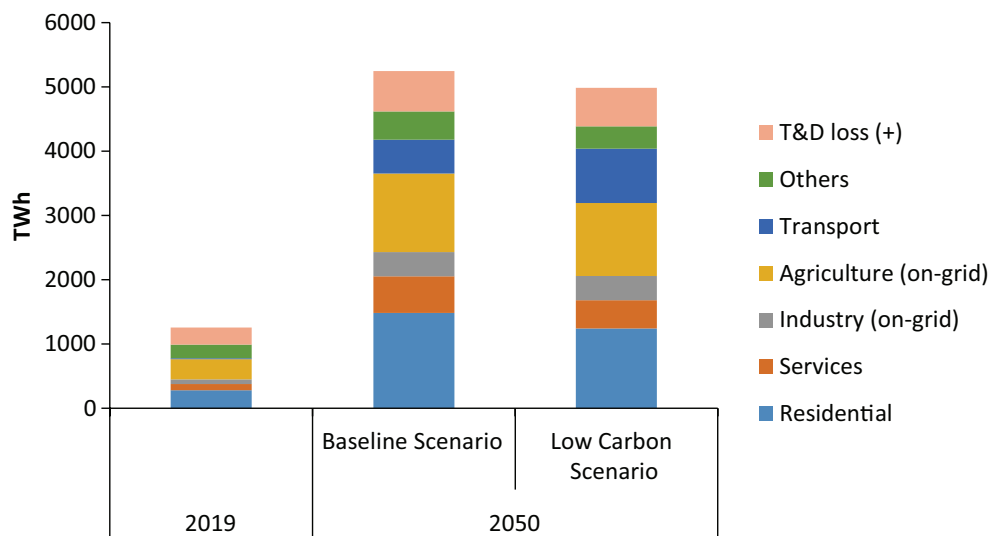
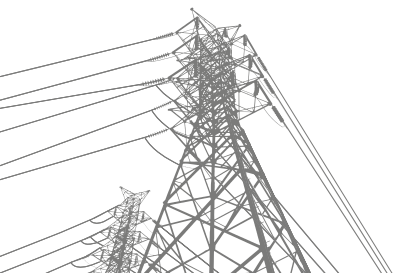

Figure E1: Grid electricity demand (ex-bus)



of electric vehicles (EVs). The study estimates that the grid electricity generation requirement is likely to increase fourfold, from 1210 TWh in 2019 to 5246 TWh and 4985 TWh by 2050 in baseline and low carbon scenarios, respectively (Figure E1). The peak electricity demand will range between 700 GW and 750 GW in the low carbon and baseline scenario respectively, by 2050.

2. Decarbonization of the power sector is expected to lower the overall system costs

Across all the study scenarios, the system cost¹ reduced by 30%–40% by 2050 from today's level (Figure E2) due to the substitution of thermal generation, having a higher fixed and variable cost, with cheaper RE-based generation.

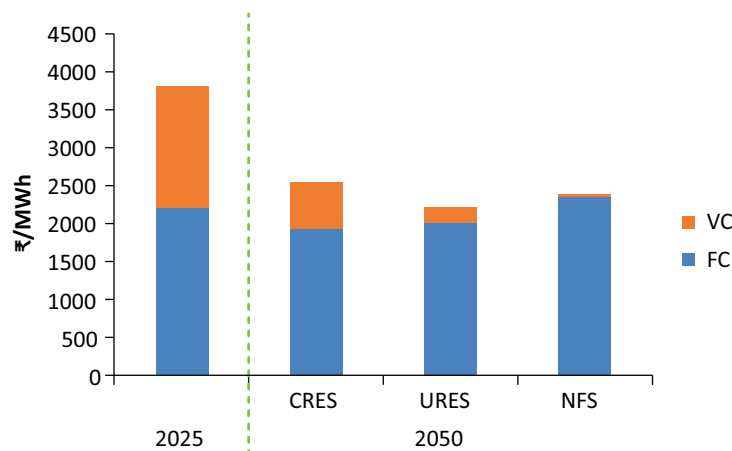

Figure E2: System cost across scenarios in 2050

The unconstrained RE scenario is the most cost-optimal solution and has the lowest per-unit system cost compared to the other two supply scenarios. The limit on RE potential in the CRES scenario increases the build-up of fossil fuel-based generation capacity. The higher variable cost of these technologies in the CRES yields ~10% higher system cost as compared to the URES. Similarly, in the NFS, the overall system cost is higher as compared to the same in the URES, as solar PV and battery energy storage system (BESS) capacity replace relatively inexpensive existing and new pithead plants that contribute to intraday and seasonal balancing. Moreover, the BESS capacity is underutilized, and there is a substantial increase in curtailment, which further increases the system cost in the NFS.

3. Large scale RE integration can reduce grid emissions intensity up to 90%

With the current assessment of technology-wise cost projections based on learning curves, the study suggests that the variable renewable energy (VRE) capacity up to a share of 85%–90% by 2050 is plausible, at a relatively low system cost and with a suite of flexible supply options.

¹ Here, the system cost is the ratio of the sum of annual fixed and variable charges (fuel cost, including start-up cost) payable for all the technologies to the total generation by the technologies in the year. It excludes the transmission and distribution costs, and penalties of heat rate and auxiliary power consumption due to the part-load operation of generating units. Various costs under system cost estimation are based on the base year 2018 pricing and adjusted for inflation, i.e., no inflation impact on pricing.

In the URES, the solar PV and wind capacity are found to be 1472 GW and 421 GW, respectively, further increasing to 1839 GW and 368 GW in the NFS.

This VRE integration is likely to be driven by solar photovoltaic technology, complemented by the addition of BESS. The capacity addition of solar PV and BESS emerges as the least-cost option as compared to other technologies such as nuclear, hydro, and non-pithead coal power stations. This results in a significant reduction in aggregate electricity sector emissions. In the URES, the overall grid emission factor reduces to the level of 70 gCO₂/kWh, i.e., 90% lower than the present level of 710 gCO₂/kWh (Figure E3).

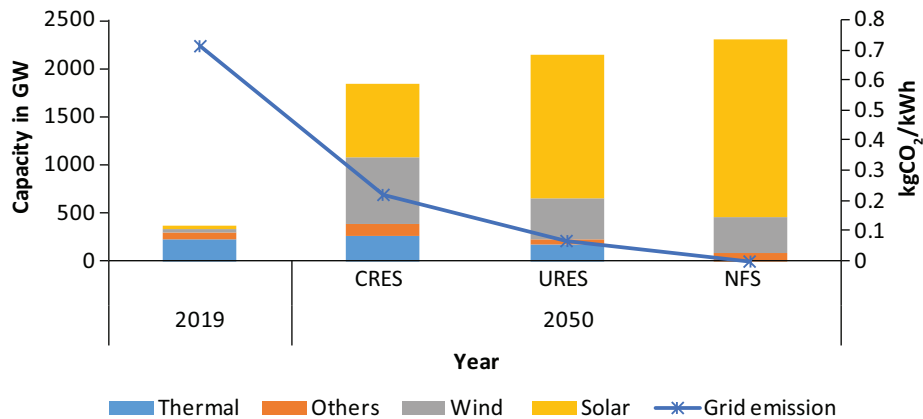

Figure E3: Capacity mix and grid emission factor in 2050

A key challenge in India's renewable energy transition lies in the scale of transformation needed in the power system and the scale of RE addition required annually. To achieve renewable capacities across scenarios, India will need to add an average of about 62 GW (50 GW solar and 12 GW wind) of RE capacity every year until 2050, which is a formidable task considering the highest annual addition of RE so far. This scale-up also highlights the massive investments required in RE and BESS.

4. Techno-economic assessment of India's RE resource potential and land requirement demand critical attention

The limit on resource potential in the CRES, despite the cost-competitiveness of solar PV and wind, caps the build-up of solar PV and wind to their maximum potential assessed so far. The residual electricity demand is met through the build-up of new coal and nuclear generation.

On relaxing the RE resource potential constraints in the URES, there is a significant increase in the build-up of solar PV and BESS capacity. This underscores the need for a detailed techno-economic assessment of RE resource potential for solar PV and wind, including off-shore wind, floating solar PV, and rooftop solar.

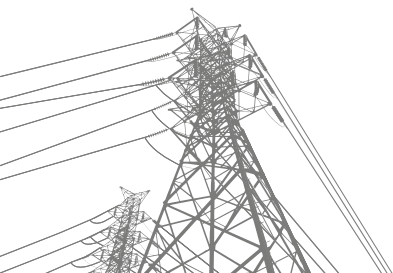

5. The role of energy storage technologies would be crucial in the large-scale grid integration of VRE

The success of the decarbonization of power sector in India depends on the success of energy storage technologies. A suite of large-scale flexible supply options, including cross-border electricity trade, has to be explored to support a high degree of VRE penetration. In all the scenarios, energy storage, including BESS, pumped hydro, etc., plays a vital role in integrating a high level of RE in the energy mix. Solar PV and BESS capacity would replace non-pithead coal generators and even substitute the cheaper pithead coal-based power plants by 2040.

In the URES, the BESS capacity requirement is 864 GW with a 6-hour duration (Figure E4). In the NFS, this requirement increases further to 1170 GW for a similar duration.

Despite the high-capacity build-up, BESS is not viable for long-term storage/seasonal balancing, mainly catered by pumped hydro, gas-based, and coal-based generators.

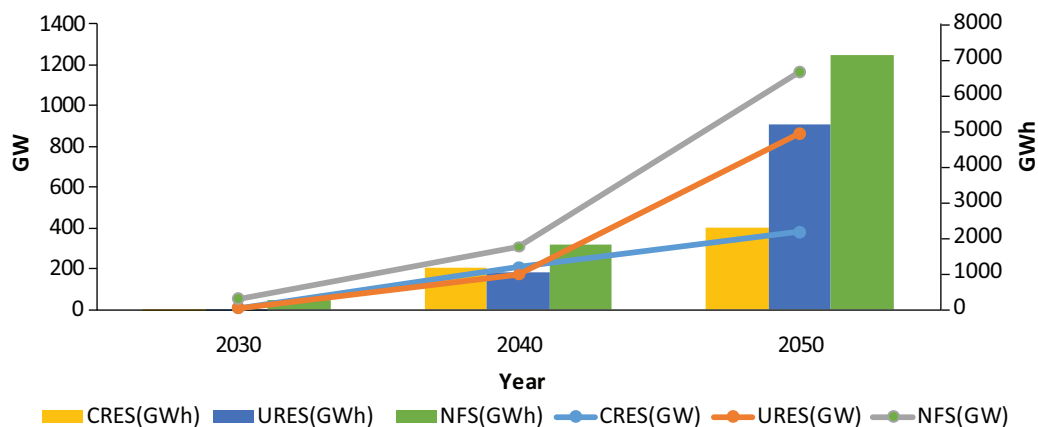

Figure E4: Battery size requirements across scenarios

6. All three scenarios show a limited dependency on coal-based plants, but these plants have an important role in meeting daily and seasonal peak demand in the long-term

Presently, coal-based generation caters to approximately 75% of the total electricity demand. However, the generation mix is likely to change significantly by 2050, with the contribution from coal reducing to ~10% of the total generation mix in the URES.

By 2050, coal-based plants will play a vital role in meeting the daily and seasonal peak electricity demand. While the pithead coal generators could support the daily peak electricity demand, the non-pithead plants will be suitable to support seasonal balancing.

Non-pithead coal generators, rather than the build-up of new BESS, would be a cost-effective proposition in supplying power for a shorter duration to meet the peak demand or during low RE generation periods. As per the model's results for 2050, due to the incremental seasonal demand, operating the unutilized non-pithead stations running at a lower utilization factor is cheaper than building additional capacity for a short duration supply. The flexibility requirements from coal power generators would be challenging in the real-world operation because these generators would be required to operate within a range that is much beyond the range in which they have hitherto been operating. The additional flexibility requirements could call for retrofitting, thereby entailing additional capital expenditure (CAPEX) leading to an increase in tariff.²

7. Trillion-dollar new investments would be required in generation capacity and BESS by 2050

For integrating such large-scale renewable capacity into the grid, new investments in the range of USD 1.2 - 1.6 trillion would be needed by 2050 to build generation capacity and energy storage to supply the growing electricity demand in India (Figure E5).

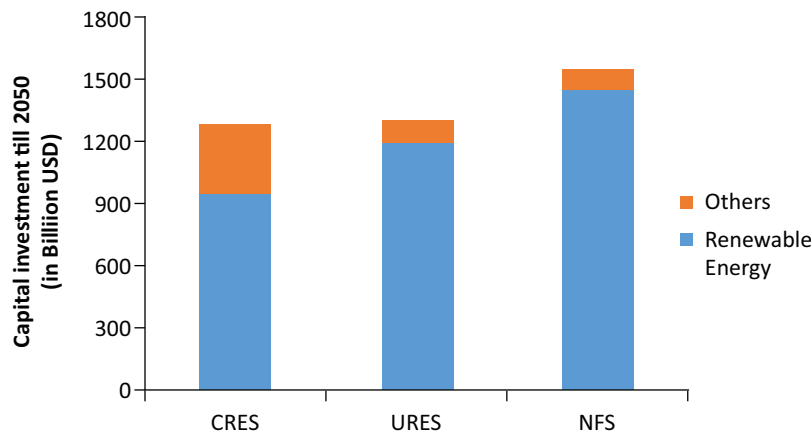

Figure E5: Investment required till 2050

The annual expenditure would be about 43 billion USD per year, which is about 1.4% of today's GDP; averaged over the period up to 2050, it would decrease as a share of GDP as the latter is bound to grow. Additionally, investments would be required in the transmission and distribution system. The investment needed for VRE + BESS would be ~75% and ~90% of the total investment in CRES and URES, respectively. In the NFS, this would increase further to 93% of the total investment requirement by 2050.

² https://cea.nic.in/old/reports/others/thermal/trm/flexible_operation.pdf



8. Looking forward

This study is based on our current assessment with respect to the growth/development of current/new technologies, demand growth, and consumer behaviour. Though the work is exhaustive, it opens new avenues for further research and a analysis. With the increasing RE penetration and reduction in the number of synchronous machines in operation, the overall inertia of the system is decreased. This reduces the resilience of the grid to withstand critical contingencies and compromises its security and stability. This necessitates the stability assessment of the grid, considering the generation mix from conventional and VRE sources as well as BESS.

The cross-border electricity trade (CBET) between India and its neighbouring countries is also expected to gain momentum in the near future. Such initiatives may result in a reduction in the generation reserve and storage requirements in India. Hence, these developments also need to be taken into account. The study, therefore, needs periodic review.

1. Introduction



India is currently the third-largest energy-consuming country in the world, with ~80% of its energy demand still being met by fossil fuels. Although energy use has doubled since 2000, India's per capita energy consumption is still less than half of the world average.³ The low per capita consumption and the estimated rate of industrialization and urbanization mean that India's potential electricity demand remains enormous. The manner in which this demand is met needs to be addressed from not only an economic and a social development perspective but also through the lens of environmental sustainability.

To ensure rapid economic growth through the mid-century and improve the standard of living, it is imperative that the central government and state governments promote the development of round-the-clock, reliable, and quality supply, duly keeping in mind energy security and affordability. In this report, we analyse the cost of supply and security. The transition of the power sector in India is of particular importance given that it contributes to approximately 50% of the country's CO₂ emissions.⁴

The costs of this transition matter a great deal for a developing country like India where electricity consumption continues to be sensitive to the price of electricity.

In India, the recent wind and solar PV auctions have delivered some of the lowest electricity prices as compared to other countries. Currently, electricity from new solar PV and wind plants is the most cost-effective choice when available.⁵ The TERI study⁶ also indicates that optimal VRE share in the generation mix by 2030 can be substantially higher from today's level.

Although the projected cost of solar PV and wind power would make these technologies the cheapest source of electricity even after 2030, studies show that as VRE penetration increases, its value in the electricity system reduces.⁷ This can be attributed to an increase in the integration costs due to the temporal variability, uncertainty, and locational constraints associated with VRE generation. It is also expected that India will have a much higher requirement for flexibility in the power system as compared to most of the countries in the world,⁸ and the source and cost of providing the flexibility will have to be addressed while planning India's long-term decarbonization strategy.

While there have been several studies^{9, 10} that look at the mid-term challenges to integrate a high share of renewables in the electricity mix, detailed studies exploring long-term renewable integration pathways to 2050 are scarce. This study explores the pathways ahead for India as it seeks to ensure reliable, affordable and sustainable energy for a growing population. With increasing demand, a set of three 'Transition Pathways' namely - Constrained RE Scenario (CRES), Unconstrained RE Scenario (URES), and No Fossil-fuel Scenario (NFS) was developed to examine the influence of different parameters in India's long-term electricity transition. The scenarios are dealt with in detail in Section 5.

³ <https://www.iea.org/reports/india-energy-outlook-2021>

⁴ <https://www.cseindia.org/reducing-co2-footprints-of-india-s-coal-based-power-sector-10552>

⁵ <https://www.bloomberg.com/opinion/articles/2019-11-07/wind-and-solar-power-have-become-amazingly-affordable>

⁶ <https://www.teriin.org/sites/default/files/2020-07/Renewable-Power-Pathways-Report.pdf>

⁷ <https://www.forbes.com/sites/michaelshellenberger/2018/04/25/yes-solar-and-wind-really-do-increase-electricity-prices-and-for-inherently-physical-reasons/?sh=2ebf919117e8>

⁸ <https://www.iea.org/commentaries/india-needs-a-range-of-options-to-unlock-the-full-flexibility-of-its-power-system>

⁹ <https://www.iaee.org/en/publications/newsletterdl.aspx?id=434>

¹⁰ <https://www.nrel.gov/docs/fy20osti/76153.pdf>

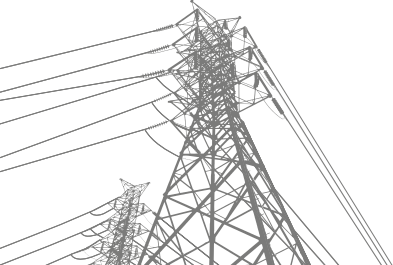

2. Modelling Description and Assumptions



2.1 Modelling Framework

The Python for Power System Analysis (PyPSA) toolbox was used for this study. PyPSA is an open source toolbox for simulating and optimizing modern electrical power systems over multiple periods. We use the PyPSA toolbox through a workflow that TERI developed to run a multi-period myopic power system operation and capacity expansion model.

Capacity expansion models must balance the need for a detailed representation of the electricity sector with computational complexity. Planning tools vary significantly in their treatment of operating constraints, energy prices, demand projections, as well as temporal and geographic resolutions. For power systems such as that of India, where VRE technologies are expected to play a significant role in the future generation mix, the appropriate tool should capture the temporal characteristics of VRE technologies and their applications, the location-specific attributes of these resources, and the inherent uncertainty and variability in wind and solar PV generation.

The existing PyPSA functionality includes various power system components, optimized power flow constraints, coupling to other energy sectors, mixed unit commitment constraints, etc.¹¹ A workflow to run a multi-period myopic power system optimization and further development to PyPSA was undertaken to incorporate components essential to represent the Indian power system while considering the computational challenges, which is elaborated through the next sections. This power system operation and capacity planning (PSO-CP) model developed using PyPSA is termed as PyPSA-India. The model had to be tuned to accurately consider generator characteristics in India and appropriate temporal and spatial representations.

2.2 Additional Functionality Developed

2.2.1 Myopic Optimization for Capacity Expansion

PyPSA-India can be configured to consider the investment decisions and operating constraints for one or more years and for different time intervals (e.g., 1 hour, 2 hours, 15 minutes) in any fixed interval here 5 years. The operational and investment costs are optimized for this period. We sequentially run the model wherein the outputs from a five-year block are used as inputs for the next five-year block, as depicted in Figure 1.

The last year of every five-year block is assumed to be the investment year, i.e., investment decisions are made considering constraints for this year for the entire five-year block.

Furthermore, the complexity of the model is reduced, as shown in Figure 1, by considering a week to represent an entire month, while running the model at an hourly resolution to reduce the number of hourly timestamps from 8760 to 2016. The selected week is the week with the highest peak load.

¹¹ PyPSA: Python for Power System Analysis; Tom Brown, Jonas Hörsch, David Schlachtberger



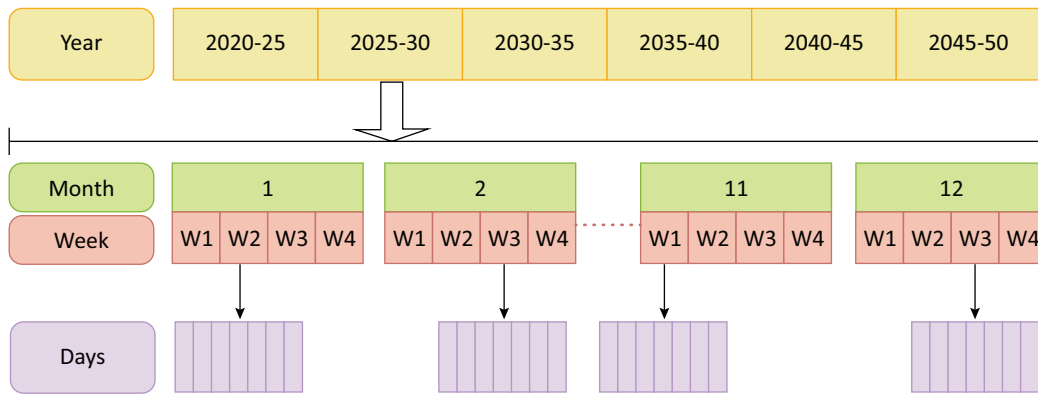

Figure 1: Schematic of typical days selected for optimization

2.2.2 Clustering of Generators

The integer commitment variables are set to model the number of running generating units (in a cluster) at any particular timestamp, hence unit commitment decisions are eased without a need for a large set of binary variables. Incorporation of the status (ON-OFF) using binary (0 or 1) variables is used to model the thermal constraints of a generating unit, since there are more than 600 coal-based thermal generating units in India.

The number of mixed-integer variables and constraints required to model each thermal generating unit individually would result in a non-tractable optimization problem, particularly while running a PSO-CP model. It is essential to incorporate the thermal constraints while running a PSO-CP model for India. The integer clustering method was used to combine thermal generating units of similar characteristics into clusters. In other words, the binary commitment variables representing the ON/OFF status of the generator are replaced by integer commitment variables and additional constraints that define the number of running generating units (in a cluster) at any timestamp.¹²

In this way, clustering still captures integer commitment decisions and associated relations at the individual plant level, subject to the simplifying assumption that all clustered units have identical parameters (e.g., capacity size, ramp rates, heat rate, minimum-up time) and that all committed units in a given time step are operating at the same power output per unit.¹³ All of the other generator variables—such as power output level—and constraints are then aggregated for the entire cluster.

Generators that have similar operating parameters are clustered together to form one clustered generator. For the purpose of this study, all generators of the same fuel type and connected to the same regional node are clustered together, assuming technical parameters as shown in Figure 2.

¹² B. Palmintier and M. Webster, "Impact of unit commitment constraints on generation expansion planning with renewables," 2011 IEEE Power and Energy Society General Meeting, 2011, pp. 1-7, doi: 10.1109/PES.2011.6038963.

¹³ <https://energy.mit.edu/wp-content/uploads/2017/10/Enhanced-Decision-Support-for-a-Changing-Electricity-Landscape.pdf>

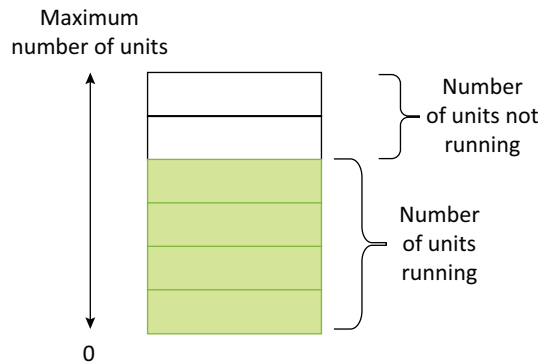

Figure 2: Characteristics of clustered generators

2.2.3 Retirement of Generators

In capacity planning models, decisions can be made to either build or retire generators, storage, transmission capacity, etc., in any period. The decision to build generators depends on the increase in load, capital cost, operating constraints, and reserve requirements.

Furthermore, the decision to retire the asset (before the end of PPA) is influenced by the payment that procurers will make to the generating company for loss of future cash flows of fixed charge in the balance period of PPA. This may be in the form of one time payment or in suitable installments.¹⁴

However, in the present study, the retirement of an asset is allowed only after the end of its economic lifetime. This decreases the number of decision variables and reduces the model complexity, thereby reducing the model run-time.

2.2.4 Reserve Requirement

The operating reserve is assumed to be 5% of the electricity demand and 5% of the forecasted wind generation in each region for every timestamp. The operating reserve requirement is assumed to meet the uncertainty due to the load forecast error. Whereas, a 5% wind generation forecast error is considered due to high intraday and seasonal intermittency. While solar PV also has intraday variability, it is not considered towards operating reserve requirement. The maximum contribution by any generator depends on its maximum ramp rate. Therefore, the maximum capacity that each generator contributes to the reserve requirement is limited. Contribution to the operating reserve can be provided by despatchable generators, such as coal, gas, and hydro (with pondage), and storage, such as battery storage and pumped hydro as shown in Table 1.¹⁵

¹⁴ The technical lifetime is the maximum operating age of the plant, after which it must be retired or refurbished.

¹⁵ *Least-Cost Pathways for India's Electric Power Sector*

Amy Rose, Ilya Chernyakhovskiy, David Palchak, Sam Koebrich, and Mohit Joshi
National Renewable Energy Laboratory



Table 1: Cost of providing reserve margin and its capacity contribution

Technology	Cost of Providing Operating Reserve (Rs/MW)	Maximum Capacity Contribution to Operating Reserve (%)
Coal Power Plant	1053	10
Hydro Power Plant with Storage	140	100
Combined Cycle Gas Plant	421	30
Battery Energy Storage	0	100
Pumped Hydro Storage	0	100

The reserve contribution by pumped hydro storage is constrained not only by its rated power but also by the water level in the reservoir at any timestamp. Similarly, for BESS, the reserve contribution is limited by its rated power as well as the available charge in the battery at any given timestamp.

2.2.5 Pumped Hydro Storage

Pumped hydro storage and hydro-generator (with pondage) are modelled as shown in Figure 3. The upper bound on the monthly capacity utilization factor (CUF) of hydro generators (with pondage) limits the output of these generators. Moreover, the maximum pumping and generating output of pumped hydro storage is limited by the hydro-generator capacity for each region or the capacity constraint of pumped hydro storage, whichever is lower, as observed in Equations 1, 2, 3.

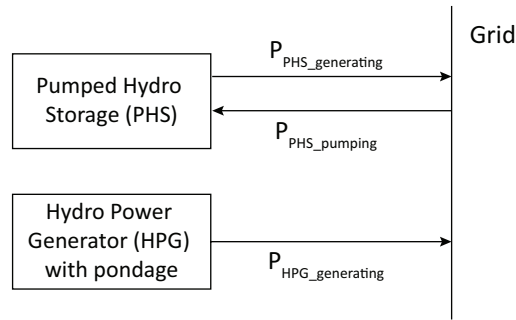
**Figure 3:** Representation of Pumped Hydro Storage in model

$$P_{HPG_generating_power} + P_{PHS_pumping_power} + P_{PHS_generating_power} \leq P_{rated_HPG} \quad (\text{Equation 1})$$

$$P_{PHS_generating_power} \leq P_{max_rated_PHS} \quad (\text{Scenario based}) \quad (\text{Equation 2})$$

$$P_{PHS_pumping_power} \leq P_{max_rated_PHS} \quad (\text{Scenario based}) \quad (\text{Equation 3})$$

2.2.6 Battery Energy Storage

In this study, BESS is modelled as shown in Figure 4. The inverter capacity (MW) and the storage capacity (MWh) of the BESS are optimized, while limiting the maximum inverter capacity, to ensure a maximum discharge rate of 1C (typical of a Lithium-ion battery).

BESS charges through a charging link and discharges through a discharging link to model the BESS charge and discharge through an inverter as seen in Equations 4 and 5, respectively. The lifetime of the BESS is assumed to be ten years, and the reduction in life due to excessive cycling is not considered. Since the lifetime of a BESS system depends on the number of operating cycles, and to ensure that the lifetime is maintained at ten years, the duty cycles of the BESS system are limited to 365 cycles per year. This is shown in Equation 7.

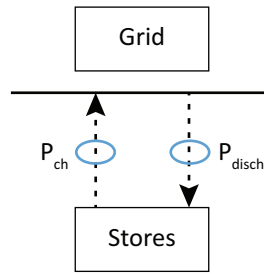

Figure 4: Representation of Battery Storage in Model

$$P_{ch(t)} \leq P_{rated_charging} \quad (\text{Equation 4})$$

$$P_{disch(t)} \leq P_{rated_discharging} \quad (\text{Equation 5})$$

$$P_{rated_charging} = P_{rated_discharging} \quad (\text{Equation 6})$$

$$\sum_{t=T}^{T+period} P_{ch(t)} \leq P_{rated_discharging} * period * N_cycles \quad (\text{Equation 7})$$

2.3 Spatial and Time Scale Granularity

2.3.1 Spatial Granularity

For this study, the power-system in the country is demarcated as Northern, Western, Eastern, Southern, and North-Eastern grid nodes. The aggregate demand for electricity in all the states in a node constitutes the nodal demand. All the existing generating stations, as per their location, are lumped at their respective regional nodes. Each node contains multiple resource zones with different potential (MW) for ground-mounted solar PV and on-shore wind and with distinct generation profiles.



2.3.2 Time-scale Selection

Time slices are selected to incorporate seasonality across the year and inter-day variability of electricity demand and renewable energy generation. The capacity build-up for each block is optimized considering the time-varying electricity demand of the last year in each 5-year time block.

The number of timestamps considered in the investment year is reduced to 2016 hours (84 days = 7 days of 12 months) at an hourly resolution to get a more manageable simulation time. This is done to ensure an appropriate representation of seasonal and inter-day variability of electricity demand.

Each month is represented by a continuous week (Monday–Sunday)--the week which witnessed the peak load for the month. Furthermore, the time series load data at an hourly resolution for the aforementioned representative weeks is appropriately stitched together to obtain a continuous load curve for a year.

2.4 Renewable Resource Potential and Generation Profile

This study uses the Regional Energy Deployment System (ReEDS) datasets for India. The ReEDS model uses supply curves for wind and solar PV to characterize the potential sites¹⁶ available for development and direct investment required to operationalise this potential.¹⁷

This dataset provides the technical potential, hourly generation profile, and fixed cost¹⁸ for each site. We consider the resource potential and the hourly generation profile for each site but assume a uniform capital cost to build the generation capacity of each technology for all the sites considered in the study. Therefore, the model considers the site-specific resource potential and its hourly generation profiles while making technology-specific investment decisions on site-specific (state-wise) capacity build-up.

For the study, multiple sites for each technology with comparable capacity utilization factors in each state were clustered together to reduce the number of candidate sites to 52.

2.5 Technology Cost

Financial parameters such as technology-specific capital costs, operating costs, fuel costs, and discount rates influence the build-up of new generation, storage and transmission capacity and their operation. RE capacity and battery storage have a learning rate that reduces the capital costs due to improved manufacturing, efficiency improvements, and scale. The model exogenously calculates the capital cost

¹⁶ Each of India's 146 resource regions/sites is assigned a maximum developable capacity (MW), interconnection cost (Rs/MW), and capacity factor by time-slice and hour for every applicable resource class of wind, solar PV, and rooftop solar PV.

¹⁷ National Renewable Energy Laboratory
(<https://www.nrel.gov/docs/fy20osti/76153.pdf>)

¹⁸ The capital cost includes the transmission upgrades required to develop the site-specific potential.

annuities for different generation and storage technologies, considering asset lifetime and the discount rate. All the cost escalations/declines are on the real currency basis with the base year of 2020, i.e., inflation of the Indian Rupee may have an adverse impact on capital cost projections.

2.5.1 Investment Cost for Various Supply-side Options

Table 2 presents the assumptions on the capital cost and lifetime of various technologies for the base year (2020). Here we considered that the plant life also represents the economic life, i.e., the capital cost of an asset is amortized over its entire lifetime, after which it retires.

Table 2: Capital cost and lifetime assumption for various technologies base year 2020

Technology	2020 Capital Cost ^{\$} (Rs Crore/MW)	Plant Lifetime (Years)
Solar PV Ground Mounted	3.5	25
Wind on-shore	5.5	25
Coal power plant (with PCE) *	8.0	25
Nuclear Power Plant (PHWR)	12.0	25
Nuclear Power Plant (LWR)	19.0	25
Hydro Power ROR	9.5	40
Hydro Power with Storage	14.5	40
Gas Combined Cycle (CCGT)	5.5	25
Small Hydro	5.5	40
Pumped Hydro	4.5	40

^{\$}: capital cost represents the initial investment required which includes land cost, main plant machinery and infrastructure, the balance of system, etc.

*PCE: Pollution control equipment for PM, SO_x, and NO_x emission control

Source: TERI compilation from CEA, LBNL, and consultations with experts

Battery Cost

The study considers aggressive reductions in BESS costs over the next two decades, in line with the Bloomberg New Energy Finance (BNEF) projections. By 2050, the capital cost of BESS (both energy and power components) is assumed to reduce to USD 60/kWh from the current cost of USD 180-200/kWh. The energy and power component costs are bifurcated considering suitable assumptions.¹⁹ The capital cost projections for 1-hour battery energy storage are presented in Figure 5.

¹⁹ <https://eta-publications.lbl.gov/sites/default/files/lbnl-2001314.pdf>



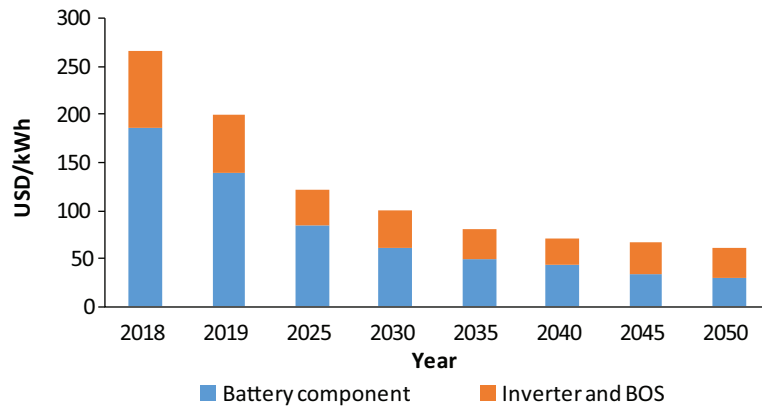

Figure 5: Hourly capital cost for battery energy storage system

Increasing cost of coal versus the cheaper RE source and energy storage

Solar energy is now the cheapest resource available in the country. Solar tariffs as low as Rs 1.99/kWh have been observed in competitive bidding due to various reasons - fall in module prices being the main one. Though the same tariff is not replicable as parameters vary from auction to auction, we estimate that the average solar PV tariff will reduce up to the level of Rs 1.50/kWh by 2050 from the current average tariff of Rs 2.50/kWh.

From Figure B-1, it can be seen that coal-based power, particularly non-pithead power stations, are projected to be less competitive across the projection period due to its rising fuel cost and the increased capital costs. As discussed in the subsequent Section 2.5.2 on fuel cost, we adopt conservative fuel cost escalation. Even with a lower escalation in fuel cost, the variable cost alone of most of the non-pithead plants will be higher than the RE levelized cost of electricity (LCOE) by the year 2030.

In energy storage space, Lithium-ion battery cost projections look promising. We estimate that the LCOE (Rs 4.80/kWh) of Li-ion battery with storage of 4 hrs supplemented with solar PV will be competitive with the non-pithead coal plants by the year 2030. The LCOE of Li-ion battery storage is likely to reduce further to Rs 2.50-3.00/kWh by 2045, and hence compete with the LCOE of pithead plants on a stand-alone basis.

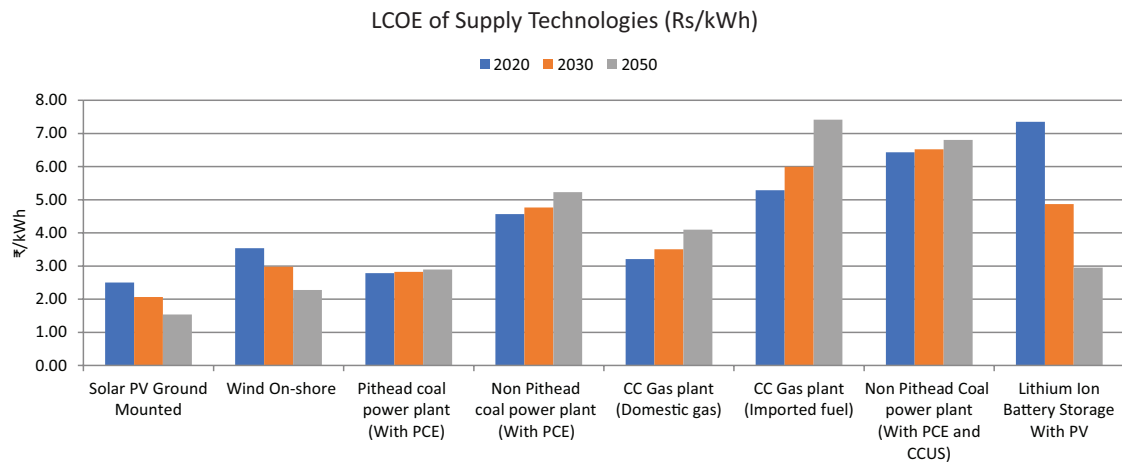

Figure B-1: LCOE of various technologies in years 2020, 2030, and 2050

The above calculations use the accepted formula for calculating the LCOE (required tariff to meet equity rate of return), not the CERC tariff formula. Common across all technologies is the assumption of 10% WACC, 33% corporate tax rate, and SLM depreciation.

It is worthwhile noting that care needs to be taken in comparing the LCOE of different technologies. VRE additionally leads to further grid integration costs such as balancing, transmission, and profile costs that are not reflected in LCOE. Fossil fuel-based technologies have significant environmental externalities related to climate change and local air pollution. Thus, the LCOE comparison gives only one perspective on the relative competitiveness of different supply technologies and needs to be complemented with grid integration and societal costs.

2.5.2 Fuel Cost, Operation and Maintenance Cost, and Discount Rate

Fuel Cost

Coal Cost: The study assumes a uniform fuel cost at the regional level for a technology-specific generation capacity. No change is assumed for coal-fired thermal power plants in the run of mine (ROM) coal cost, and coal cess is also considered to be constant across all investment timestamps. However, an increase of 1% in the transportation charges is assumed to arrive at the landed cost of coal at the power plants. The variable cost of coal-fired thermal generators was calculated considering a gross calorific value (GCV) of 3850 kCal/kg and category-wise (unit size and technology) heat rate. In this study, we have considered the domestic coal price at the 2020 level as per the price notification issued by the Coal India Limited.

Gas Price: Due to a significant difference between domestic and imported gas prices, the fuel cost for each was estimated separately. The domestic gas price in India is hitherto controlled by the Central Government with an assessed price under the administered price mechanism (APM). However, the landed price of



imported gas depends on the global gas price, which is influenced by various demand- and supply-side factors and further depends on the term of the purchase contract. The final cost also comprises gas pipeline tariff and tax.

For this study, we have considered the average notified domestic gas price at the 2018 level, i.e., USD 2.5/MMBtu, and the landed cost of imported gas as USD 5.7/MMBtu. We escalated the cost in real terms by 1.5% each year to 2050. Over and above, we added an average pipeline transmission tariff of USD 0.6/MMBtu, assuming the transmission tariff of Gas Authority of India Limited (GAIL) for the 600 km pipeline.

Further, we assumed an 18% tax on the gas transmission tariff and a 5% state tax over and above the respective price of gas to project the delivered cost of domestic and imported gas (USD 5/MMBtu for domestic gas and USD 11/MMBtu for imported gas by 2050).

Operation and Maintenance Cost

Fixed O&M (FOM) costs are the costs of power plant operations and maintenance incurred whether or not the power plant is generating electricity (for example, the costs of regular maintenance, monitoring, and inspection). FOM costs for conventional technologies are assumed as per the Central Electricity Regulatory Commission (CERC) Tariff Regulation,²⁰ whereas that for RE generators are considered to be comparatively lower in the range of Rs 4–7 Lakhs/MW.

Discount Rate

The discount rate affects investment decisions as it is used to calculate the fixed cost annuity for new assets. This study does not consider technology-specific and year-wise discount rates but a constant discount rate of 10% for all the technologies and investment years.

2.6 Transmission Network and Cost Assumption

As described in Section 2.3, the Indian power system is divided into five sub-regions for planning and investment optimization. These regions are interconnected through the inter-regional transmission network. To simplify transmission line representation for modelling purposes, we cluster all the inter-regional transmission lines between two regions as one line between them.

The total cost of adding transmission line capacity between two regions depends on the transmission capacity to be added, capital costs per unit capacity, and distance between regional nodes. The assumptions are presented in Table 3.

The cost assumptions are based on the capital cost of a 400 kV transmission line. The capital cost per km is assumed as Rs 66 lakh/km at a surge impedance loading (SIL) of 515 MW, as per CERC regulations.²¹ The overall capital cost for the transmission system in (MW/km) is obtained by dividing capital cost per km average line length by the transmission line capacity assumed at an 85% availability factor. Table 4 summarizes the assumption considered for the calculation.

²⁰ <https://cercind.gov.in/2019/regulation/Tariff%20Regulations-2019.pdf>

²¹ <http://www.cercind.gov.in/2020/regulation/158-Reg.pdf>

Table 3: Cost assumption for new transmission built-up

Line type (KV)	SIL (MW)	Capital cost for 400-kV line (Lakhs/km) *	Capital cost per MW-km (in Rs) #
400	515	66	10,893

*Assuming 25% reduction to the benchmark cost

Assuming 85% of the total transfer capability as available transfer capability

Further, the average distance between each region is derived by taking the average length of each of the lines built between regional nodes.

2.7 Technology Operating Parameters

Technology operating parameters such as technical minimum, minimum up time and down time, ramp rates, and start-up costs are used to model unit-commitment constraints for thermal generators. This report assumes the following technical parameters based on literature review, observations of real-world operations of Indian power plants, and discussions with sector experts, as presented in Table 4.

Table 4: Operational constraints considered²²

Constraint	Units	Coal	Gas	Hydro
Technical Minimum	% Nominal Power	55%	40%	10%
Ramp Rate Up	% Nominal Power/Hr	60%	100%	100%
Ramp Rate Down	% Nominal Power/Hr	60%	100%	100%
Minimum Up Time	Hours	6	3	0
Minimum Down Time	Hours	4	3	0
Start-up Costs	Rs/MW	14100	6690	0

²² https://cea.nic.in/old/reports/others/planning/irp/Optimal_mix_report_2029-30_FINAL.pdf



3. Electricity Demand and Load Forecasting



3.1 Electricity Demand

The importance of electricity demand projection and a robust load profile estimation is well recognized. It assumes added importance in the context of high variable renewable capacity addition envisaged. At a macro level, the electricity demand is a function of economic growth, population growth, urbanization rate, weather, energy efficiency measures, and the emergence of new demand drivers. These variables are largely uncertain and difficult to predict in the long-term. Therefore, in order to estimate the electricity demand in 2050, we explored some plausible 'scenarios' considering the key macro economic drivers like gross domestic product (GDP), population, residential demand etc., and examined the pathways to achieve high RE integration in the power sector.

3.2 Demand Projection Methodology and Key Assumptions

The two scenarios explored for the electricity demand forecast are the baseline scenario and the low carbon scenario. The 'baseline scenario' considers moderate efficiency improvements across residential commercial, agricultural, and non-specified industries and a moderate penetration of electric vehicles and electric cooking appliances. In contrast, the 'low carbon scenario' considers a relatively high-efficiency improvement and penetration of electric vehicles and cooking appliances.

We considered the partial end-use approach that uses econometric and end-use techniques to assess the sector-wise long-term electricity demand. This approach uses the macro-economic data at the national or state level to estimate the electricity consumption through regression. In contrast, the end-use method examines ownership and uses micro-level data of individual technologies, efficiency improvement potential, consumption behaviour, etc., to project the same.

The key macro-economic drivers considered to estimate electrical demand are population, GDP, industrial and agricultural gross value added (GVA), household size, urbanization rate, etc. Table 5 summarizes the assumptions around key economic indicators considered in this study.

The following sub sections detail the assumptions, methodology, and results for the residential sector, service sector, industrial sector, agricultural sector, and transport sector.



Table 5: Macro-economic drivers

Drivers	Units	2015	2030	2050
Population	Billion	1.31	1.51	1.66
GDP	Billion USD (2011 PPP)	5748	12443	42776
Industry GVA	% of GDP	27.3%	27.4%	28%
Agriculture GVA	% of GDP	15%	12%	7%
Urbanization	%	32.77%	40.14%	52.80%
Urban household size	Person	4.6	4.28	3.83
Rural household size	Person	4.8	4.44	3.98

Source: TERI analysis based on OECD,²³ RBI (2022),²⁴ UN²⁵, World Bank²⁶

Since the beginning of this century, the Indian economy has grown at 6.75% per annum. The long-term GDP projection of the Organisation for Economic Co-operation and Development (OECD) suggests improvement in the ranking of the Indian economy in the coming decades. We considered the OECD GDP projection in this study.

Over the last 20 years, India's population has grown at a compound annual growth rate (CAGR) of 1.4% to 1.38 billion in 2020 from 1.05 billion in 2000. As per OECD projections, this will slow down to 0.6% and the population of India is estimated to reach 1.66 billion by 2050. Similarly, the urbanization rate is also estimated to increase to 52.8% by 2050 from 34% (2019 level).

3.2.1 Residential Sector

The residential sector is one of the major drivers of electricity consumption, accounting for 25% of the total electricity consumption in 2019.²⁷ Between 2000 and 2019, the demand in this sector grew by 8% per year; primarily due to increased electrical appliance penetration at the back of a rising per capita income.

We considered the econometric approach to project the sectoral electricity demand, utilizing the GDP per capita relationship ($R^2 = 0.99$).

²³ OECD (2021), Real GDP long-term forecast (indicator). doi: 10.1787/d927bc18-en (Accessed on 03 August 2021)

²⁴ <https://m.rbi.org.in/Scripts/AnnualPublications.aspx?head=Handbook%20of%20Statistics%20on%20Indian%20Economy>

²⁵ https://esa.un.org/unpd/wpp/publications/files/wpp2017_keyfindings.pdf

²⁶ <https://data.worldbank.org/indicator/PA.NUS.PPP?locations=IN>

²⁷ https://cea.nic.in/wp-content/uploads/pdm/2020/12/growth_2020.pdf

The baseline scenario does not consider any energy efficiency interventions other than the ones already implied in the econometric projections. The residential electricity demand is broken down into appliance level end-use demand to frame the low carbon scenario and incorporate possible energy efficiency interventions.

The end-use within this sector is broadly classified into electric cooking, lighting, space cooling, water heating, entertainment, etc. These end-uses were further broken down based on the technology using detailed historic appliance stock data that was developed through an extensive literature review (Table 7). Therefore, appliance level annual electricity usage is assigned based on the literature review (Table 7) and calibrated to historical electricity consumption.

The stock of each appliance was projected based on the literature review and experts' suggestions on the possible household saturation levels. For example, we referred to the National Cooling Action Plan²⁸ to project stock data of air conditioners, air coolers, fans up to 2037–38 and extrapolated the same to 2050. Further, assuming high-efficiency levels compared to the baseline scenario for key appliances, we projected the energy demand in the low carbon scenario. These high energy efficiency levels are assumed based on the technology maturity supported by government policies and schemes, e.g., the Unnat Jyoti by Affordable LEDs for All (UJALA) program²⁹ which resulted in the massive adoption of LED-based bulbs, and the star labelling programme,³⁰ which encouraged the development and penetration of energy-efficient fans, residential air conditioners, and refrigeration, resulting in significant energy savings households. Tables 6 and 7 give the stock ownership and energy intensity assumptions considered in the study.

Table 6: Residential appliances and their stock projections (in million)

	Unit	Tubular Source (FTLs)	Point Source	Fan	Air Cooler	Residential Air Conditioning	Geyser	TV	Refrigerator
2011	Million	256	665	307	20	6	20	115	43
2030	Million	449	1209	674	138	107	69	346	173
2050	Million	1276	2976	1280	404	340	234	850	425
CAGR	%	4.32%	4.02%	3.5%	8.23%	11.2%	6.69%	5.4%	6.21%

Source: TERI estimate based on NCAP, Brookings' study³¹

²⁸ <http://www.indiaenvironmentportal.org.in/files/file/DRAFT-India%20Cooling%20Action%20Plan.pdf>

²⁹ <http://www.ujala.gov.in/>

³⁰ <https://beeindia.gov.in/content/standards-labeling>

³¹ [https://www.brookings.edu/research/the-future-of-indian-electricity-demand-how-much-by-whom-and-under-what-conditions/#:~:text=of%20supply%20planning,-,Electricity%20demand%20depends%20on%20a%20number%20of%20variables%2C%20some,deep%20uncertainty%20into%20the%20future.&text=Aggregate%20electricity%20demand%20could%20grow,6.2%20percent%20CAGR\)%20by%202030.](https://www.brookings.edu/research/the-future-of-indian-electricity-demand-how-much-by-whom-and-under-what-conditions/#:~:text=of%20supply%20planning,-,Electricity%20demand%20depends%20on%20a%20number%20of%20variables%2C%20some,deep%20uncertainty%20into%20the%20future.&text=Aggregate%20electricity%20demand%20could%20grow,6.2%20percent%20CAGR)%20by%202030.)

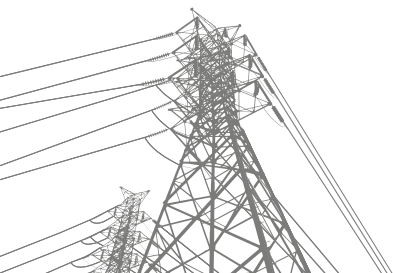

Table 7: Assumptions on annual energy consumption of residential appliances (in kWh per year)

Appliance	2011		2030		2050	
	Baseline	Baseline	Low carbon	Baseline	Low carbon	
Point Source	66	26	18	15	10	
Tubular Lighting	58	44	35	32	26	
Fan	131	102	83	96	82	
Television	160	131	110	87	75	
Air Cooler	182	252	216	266	222	
Refrigerator	400	250	200	200	160	
Residential Air Conditioner	1800	1680	1440	1628	1184	
Geyser	640	604	526	576	480	

Source: TERI assumptions based on LBNL study³²

Electric Cooking

Today, electricity is used mainly as a supporting fuel for cooking. But the use of grid electricity for cooking is gaining popularity, especially in urban households, due to the availability of appliances of good quality, evolving cooking lifestyle, and improved reliability of electricity supply. To estimate its demand potential, we assumed that electric cookstoves penetration would substantially increase post 2030 (Table 8). This stock projection is mostly in line with Brookings' study titled 'Future of Electricity Demand in India'.³³ To accurately assign energy usage levels to this end-use sector, we estimated that ~984 kWh of electricity is required per annum for complete conversion, equivalent to 10 LPG cylinders of 14.2 kg capacity. This estimation assumes 40% and 80% cookstove efficiency for LPG- and electric-based cookstoves, respectively.

Table 8: Electric Cookstove penetration.

Scenario	Unit	Electric cookstoves penetration (Number of Households)	
		2030	2050
Baseline	Million	27	170
Low carbon	Million	52	212

Source: Brookings' study³³

³² Details available at

https://www.researchgate.net/publication/330846690_Modeling_India's_energy_future_using_a_bottom-up_approach

³³ Details available at <https://www.brookings.edu/wp-content/uploads/2018/10/The-future-of-Indian-electricity-demand.pdf>

Results

The analysis suggests that the residential electricity demand is expected to grow at the rate of 5.2% and 4.8% each year to 2050, reaching to 1483 TWh and 1239 TW in baseline and low carbon scenarios, respectively. The results are shown in Table 9.

Table 9: Summary of residential sector demand analysis and projection

Scenario	Cooling demand (TWh)		Total Residential demand (TWh)		Share of cooling demand in total residential demand	
	2030	2050	2030	2050	2030	2050
Baseline	256	784	634	1483	40%	53%
Low carbon	220	582	567	1239	39%	47%

Source: TERI analysis

The results also suggest that the demand for cooling will drive the sectoral demand which is expected to contribute around 47%–53% of the total residential demand by 2050. As compared to the baseline scenario, the low carbon scenario resulted in energy savings in the order of 16%, garnered through appliance-level efficiency improvements. The residential air conditioning (RAC) segment is estimated to contribute the largest share in energy savings, of the order of 62%. On the other hand, the electric cooking demand is expected to rise to 132 TWh and 152 TWh in baseline and low carbon scenarios, respectively.

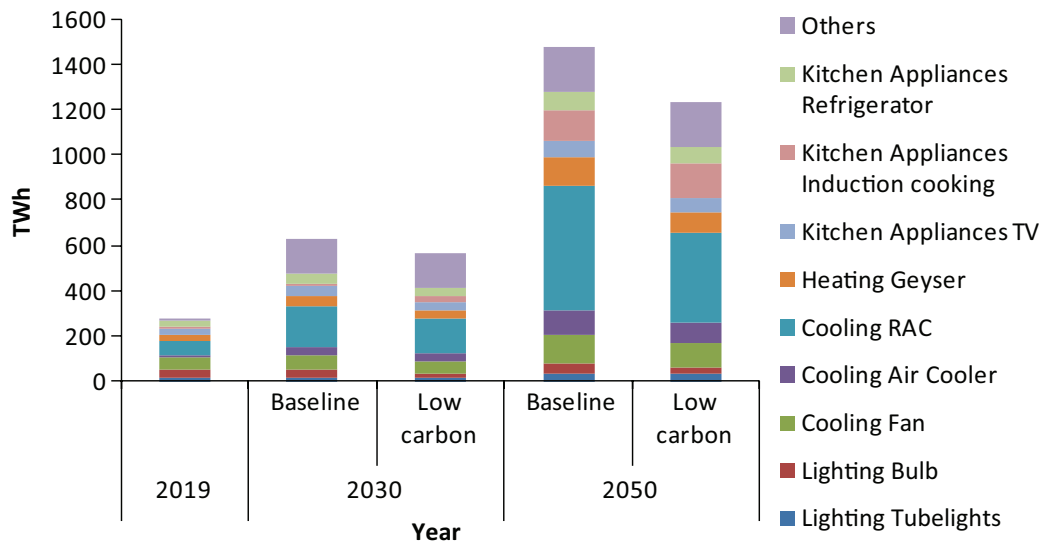

Figure 6: Projection of stock composition in residential electricity demand 2050

Source: TERI estimate based on CEA, ICAP, Brookings' study, etc.



3.2.2 Service Sector

The electricity demand in the service sector grew at ~8% per annum between 2000 and 2019, making it the fastest-growing end-use sector. Currently, the service sector accounts for ~15% of the total electricity demand. The commercial segment within the service sector grew much faster at ~9% each year during the same period. We also tried to project the demand separately through a bottom-up approach. First, to project the service sector electricity demand, we used an econometric approach, considering electricity consumption as a function of service sector value-added, in view of the strong relationship ($R^2 = 0.96$) between them. The service sector was broken down into commercial and others. Further, the commercial sector’s energy efficiency intervention assumptions were incorporated to frame a low carbon scenario.

To project the commercial sector’s electricity demand, we assumed that the commercial floor space area will grow from 1.14 billion m² in 2019 to 2.47 billion m² by 2030 and 4.76 billion m² by 2050.

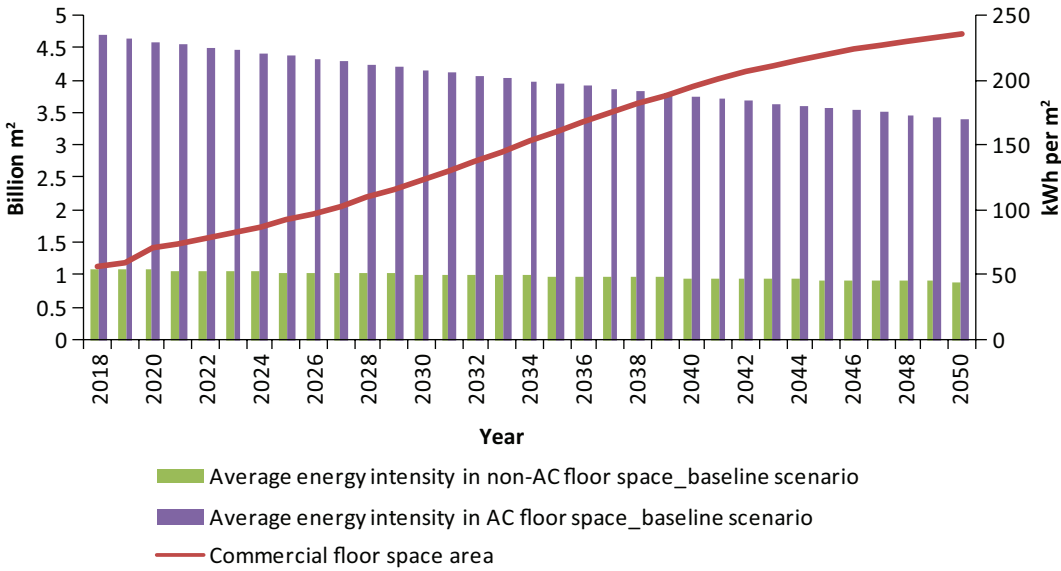

Figure 7: Projection of commercial floor space area and assumption of weighted average EPI for AC floor space and non-AC floor space in baseline scenario to 2050

Source: TERI analysis based on Brookings' study³⁴, AEEE³⁵, Sathish Kumar *et al.*³⁶

³⁴ <https://www.brookings.edu/wp-content/uploads/2018/10/The-future-of-Indian-electricity-demand.pdf>

³⁵ <http://www.aeee.in/wp-content/uploads/2018/09/Building-Stock-Modeling-Revised-pager.pdf>

³⁶ <https://doi.org/10.1080/09613218.2018.1515304>

This estimation is in line with other projections (Kumar, 2019), AEEE, etc. The share of AC floor space is estimated to increase from the present level of 8% to 23% by 2030 and 60% by 2050. As per the National Benchmarking Study of Bureau of Energy Efficiency (BEE), the weighted average energy intensity of AC and non-AC commercial building floor spaces are estimated to be around 235 KWh/m² and 55 KWh/m², respectively. Further, a modest energy-efficiency improvement rate of 0.6% for all scenarios is assumed for non-AC floor space. In air-conditioned buildings, this savings potential is considered to be slightly higher, of the order of 1% and 2% in the baseline and low carbon scenarios, respectively. Overall, as the shift from non-AC to AC floor space gradually increases, the weighted average energy intensity in commercial building floor space is expected to increase. The floor space area multiplied by energy intensity per sq. meter of floor space gives the total energy demand. For estimating other service sector demands, we subtracted commercial electricity demand from the total service sector's electricity demand and assumed it to be the same across scenarios.

Results

The results suggested that the service sector's demand would grow at 5.5% and 5% each year to 2050 in baseline and low carbon scenarios respectively, compared to the growth rate of ~8% per annum since 2000. The electricity demand is expected to reach 947 TWh and 818 TWh by 2050 in baseline and low carbon scenarios respectively, and is expected to contribute 20% of the total on-grid demand. The sectoral growth is expected to be driven majorly by the commercial segment, and the commercial sector demand is expected to reach 568 TWh and 439 TWh by 2050.

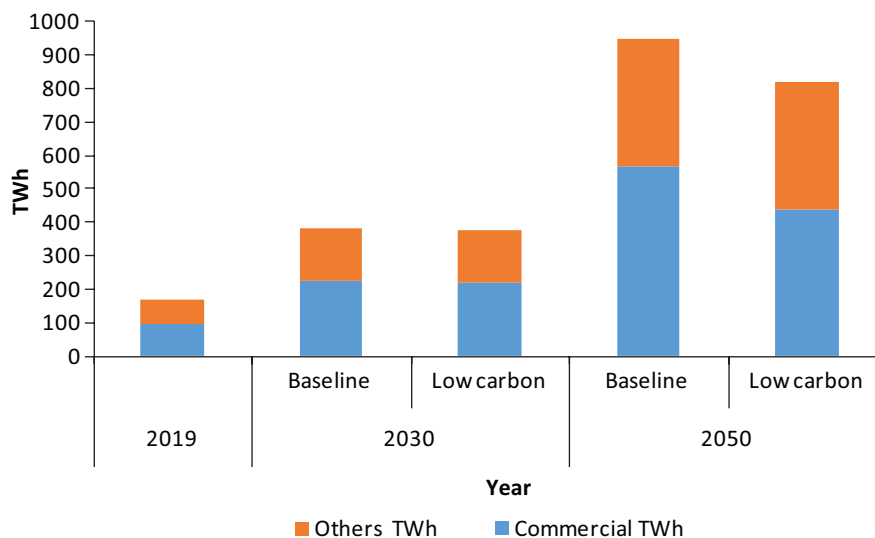

Figure 8: Summary of service sector demand analysis and projections

Source: TERI analysis



3.2.3 Industrial Sector

The industrial sector accounted for nearly 41% of the total demand in 2019.³⁷ Due to material demand and industrialization, industrial sector demand grew by 7.1% between 2000 and 2018. The government aims to boost the share of the manufacturing sector to over 20% of GDP by 2025.³⁸ In order to achieve this, the government introduced various policies and initiatives, such as ‘Make in India’, slashing corporate tax rates, etc. from time to time to support investment and growth. These forward-looking policies are expected to increase the electricity demand further in the sector.

To project sectoral demand by 2050, the industrial sector is broadly classified into energy-intensive ones and non-specified ones. The energy-intensive industries considered for the study are Iron and Steel, Aluminium, Cement, Chemicals, and Petrochemicals which include fertilizers, refineries, methanol, ethylene and propylene, and caustic soda. The rest of the industries were considered as ‘non-specified’ ones. First, we projected the industry’s sectoral demand through an econometric approach using the robust relationship between industry GVA and electricity consumption ($R^2= 0.99$). Further, to frame the low carbon scenario, we have broken down the total energy demand by estimating the demand from energy-intensive industries through a bottom-up approach. For that, industry-wise material demand is projected explicitly and multiplied with electrical intensity in their production. Since most of the technologies and processes deployed at the energy-intensive industries are near to the world average, we have not assumed significant savings in a low carbon scenario. Figure 9 summarizes the material demand projections for the key energy-intensive sectors namely steel, aluminum, and cement.

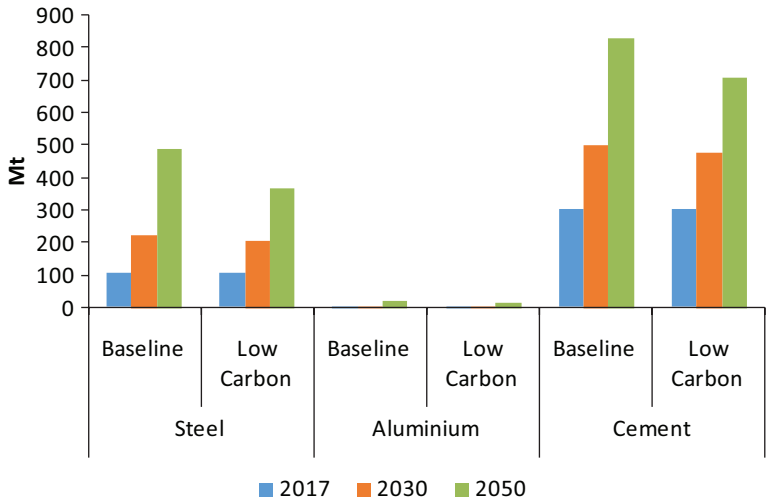

Figure 9: Results of material demand projection from key energy-intensive industries

Source: TERI analysis

³⁷ https://cea.nic.in/wp-content/uploads/pdm/2020/12/growth_2020.pdf

³⁸ sinesstoday.in/latest/economy-politics/story/govt-aims-to-boost-manufacturing-share-in-gdp-to-20-by-2025-defence-pharma-to-be-key-areas-267381-2020-07-17

Thus, the non-specified industry electricity demand is estimated by deducting the baseline energy-intensive industry demand from the total industrial sector demand. Further, modest energy efficiency improvements are considered for technologies deployed in non-specified industries. This is assuming that the energy-efficiency potential in the MSME sectors will be through the up-gradation of existing technologies and adoption of connected technologies. For example, a Shakti Foundation study³⁹ suggests that upgrading existing motors to IE3 motors and integrating systems such as variable frequency drives, soft starters, etc., itself could result in energy savings of 5% to 15%. Also, IoT-enabled technologies could help in making informed decisions and optimizing energy consumption, which is largely unexplored at present. Considering all these possible interventions, the electricity savings are assumed to increase gradually from today and reach to 15% and 20% of the total demand in baseline and low carbon scenarios respectively, by 2050.

Captive Consumption

In the industry sector, captive consumption accounts for 38% of the total industrial demand.⁴⁰ This grew at a CAGR of 7% each year between 2002 and 2019. To derive on-grid demand from the industry sector, it was assumed that the captive power consumption would gradually reduce to 5% by 2050. In CEA's 19th Electric Power Survey (EPS) report,⁴¹ the captive consumption is assumed to decline gradually by 0.5 percentage points annually. We assumed the same trend to follow in the long run, ultimately reducing its growth rate to 5%. Though the reliability of grid electricity supply is expected to improve considerably, the preference for open-access consumption of renewable electricity is expected to increase due to its cost competitiveness. The recent policies and initiatives to encourage captive renewable energy for commercial and industrial consumers could further encourage open-access.⁴² We estimated that the captive consumption would grow to 426 TWh by 2030 and 1088 TWh by 2050 and assumed to be consistent across scenarios.

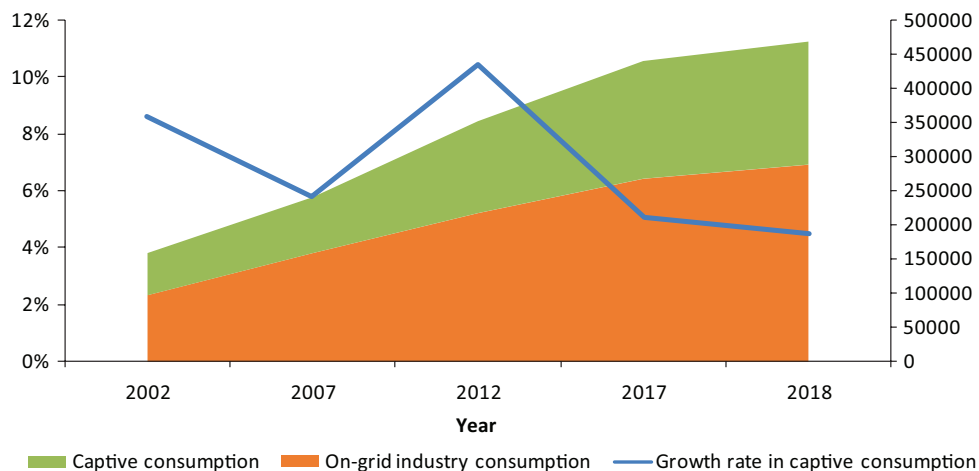

Figure 10: Historic captive consumption trend analysis

³⁹ https://shaktifoundation.in/wp-content/uploads/2017/06/Final-Project-Report_Shakti-MSME.pdf

⁴⁰ https://cea.nic.in/wp-content/uploads/pdm/2020/12/growth_2020.pdf

⁴¹ https://cea.nic.in/ps___lf/report-of-19th-electric-power-survey-of-india-by-econometric-method/?lang=en

⁴² <https://pib.gov.in/PressReleasePage.aspx?PRID=1746339>



Results

Table 10 summarizes the results for the industry sector. The sectoral on-grid demand is expected to grow to 634 TWh and 609 TWh by 2030 and 1222 TWh and 1133 TWh by 2050 respectively, in baseline and low carbon scenarios.

Table 10: Summary of industry sector demand analysis and projections

Scenario	Energy-intensive industries (TWh)		Non-specified industries (TWh)		Total industry (TWh)		Captive consumption (TWh)		Total industry on-grid demand (TWh)	
	2030	2050	2030	2050	2030	2050	2030	2050	2030	2050
Baseline	326	730	731	1500	1057	2230	426	1008	634	1222
Low Carbon	314	730	718	1411	1032	2141	426	1008	609	1133

Source: TERI analysis

3.2.4 Agricultural Sector

The agricultural sector is the backbone of the Indian economy, contributing to ~17.8% of the total GVA in 2019.⁴³ Though the major electricity use is only in pumping operation, the demand grew at a CAGR of 5.7% each year between 2000 and 2019,⁴⁴ resulting in an increasing trend of electrical intensity.⁴⁵ Other factors, such as depletion of groundwater levels, changing patterns of crops and annual rainfall, pump set efficiency, etc., have affected the sectoral electricity consumption.

To estimate the agricultural electricity consumption, we use the econometric approach based on the robust relationship with sectoral GVA ($R^2=0.97$). We assumed that as the country urbanizes, the share of sectoral value-added in GDP shrinks to 11% by 2030 and 7% by 2050 from the 2019 level. This was assumed based on cross-country analysis. For example, in developed countries such as the US, the UK, Japan, Australia, etc., we see a low share of agriculture value-added in GDP, whereas in developing countries such as China, Bangladesh, etc., the share is declining as their economies grow.

Now, to reflect the solar PV-based irrigation policies such as PM-KUSUM,⁴⁶ we assumed that 50% and 75% of the incremental demand from 2020 levels would be met through solar PV feeders by 2050 in the baseline and low carbon scenarios. The renewable-based decentralized consumption is expected to reduce the on-grid demand from the agricultural sector and, thereby, the associated T&D losses. Governments

⁴³ <https://pib.gov.in/PressReleasePage.aspx?PRID=1693205>

⁴⁴ https://cea.nic.in/wp-content/uploads/pdm/2020/12/growth_2020.pdf

⁴⁵ <https://www.teriin.org/sites/default/files/2019-02/Analysing%20and%20Projecting%20Indian%20Electricity%20Demand%20to%202030.pdf>

⁴⁶ PM-KUSUM (Pradhan Mantri Kisan Urja Suraksha evam Utthaan Mahabhiyan) Scheme| National Portal of India

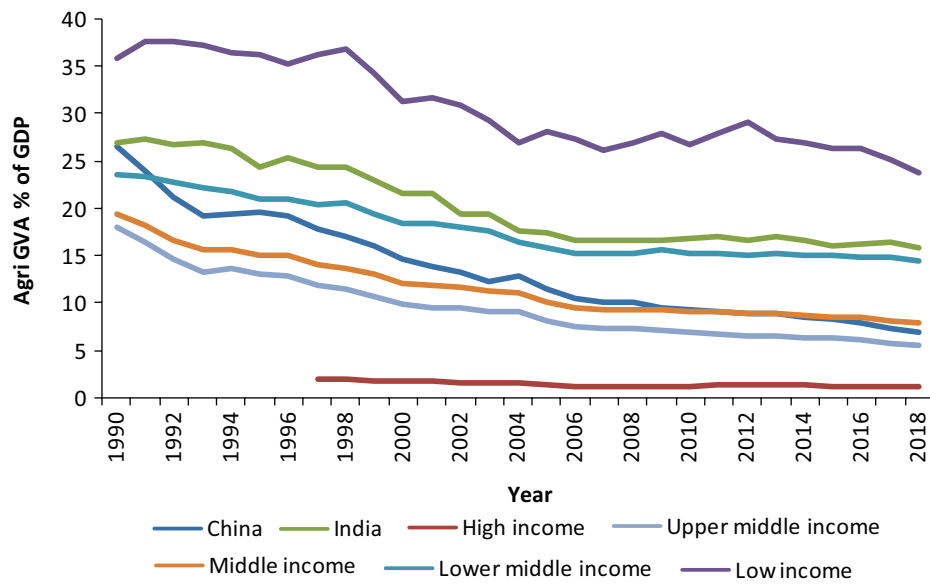

Figure 11: Historic trends in the share of agriculture GVA in total GDP for the different countries is categorized based on income levels

Source: World Bank⁴⁷

in states such as Madhya Pradesh,⁴⁸ Maharashtra,⁴⁹ Andhra Pradesh⁵⁰ have already announced policies towards this. This is expected to significantly impact the agricultural load profiles over the years as more solar feeders get operational.

Results

The total sectoral demand is expected to grow more than twice from the consumption level of 202 TWh in 2019, reaching 580 TWh by 2050 (Table 11). However, as a part of policy initiatives around solar PV pumping and solar PV feeder, etc., focussed to shift the load from the grid, the on-grid demand is expected to be 436 TWh and 347 TWh in baseline and low carbon scenarios respectively, by 2050. This reduces the share of the agricultural sector in the total electricity demand, to 9% and 8% in baseline and low carbon scenarios from 21% of the 2019 level. It is, however, worth underlining that the current

Table 11: Summary of agriculture sectoral demand analysis and projections

Scenario	Agricultural demand (TWh)		Replaced energy (TWh)		Total on-grid demand (TWh)	
	2030	2050	2030	2050	2030	2050
Baseline	391	580	22	144	369	436
Low carbon	391	580	35	233	356	347

⁴⁷ <https://data.worldbank.org/indicator/NV.AGR.TOTL.ZS?end=2020&locations=IN-CN-BR-BD-US-GB-AU-JP-RU&start=1960&view=chart>

⁴⁸ PM-KUSUM (Pradhan Mantri Kisan Urja Suraksha evam Utthaan Mahabhiyan) Scheme| National Portal of India

⁴⁹ <https://cmsolarpump.mp.gov.in/KusumA/KusumAHome>

⁵⁰ <https://www.mahadiscom.in/solar/index.html>



consumption of groundwater is not sustainable, and it would be desirable to reduce water consumption by shifting cropping patterns and increasing the efficiency of irrigation. In other words, it is not a desirable outcome for the agricultural sector electricity demand to grow so much.

3.2.5 Transport Sector

Presently, the transport sector accounts for 1% of the total electricity demand, primarily from railway traction. However, while looking in the long-term, electric mobility services are expected to emerge as a significant driver of electricity demand. The central and state governments introduced policies and initiatives that could accelerate the adoption of electric vehicles by reducing the cost of EVs and developing the charging infrastructure. The transport sector electrification aims at reducing emissions and import dependency on fossil fuels. The transition to electric vehicles is expected to occur much faster in the light-duty vehicle (LDV) segments than the freight segment due to the challenges in developing charging infrastructure, weight penalty, etc.⁵¹

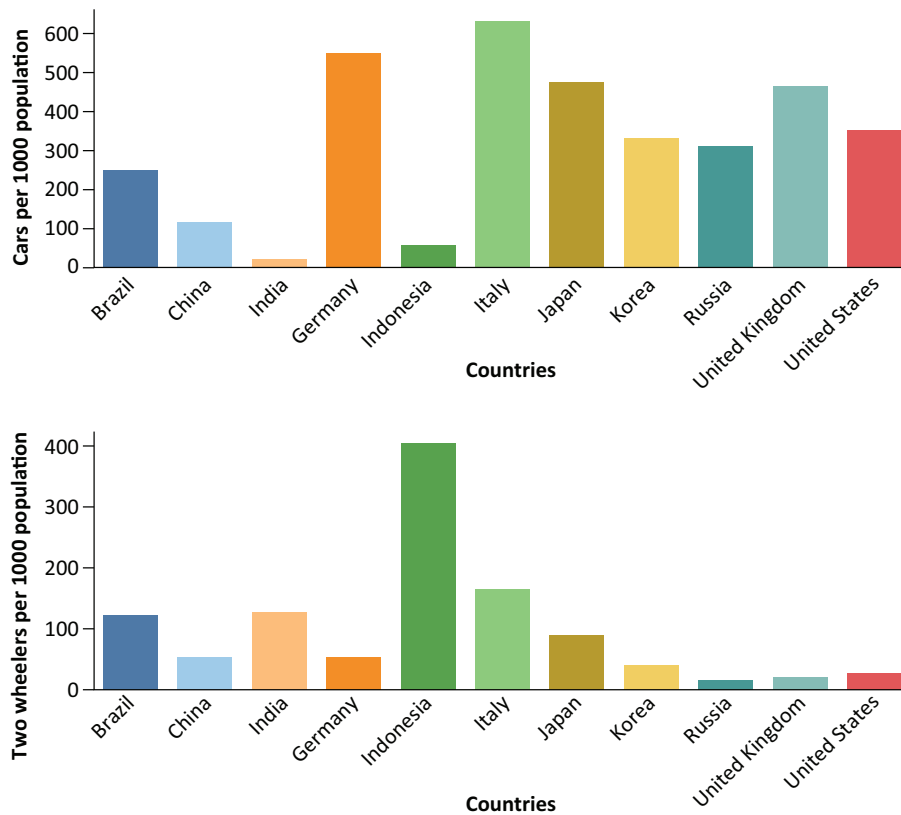

Figure 12: Country-wise comparison of cars and two wheelers per thousand population as of 2016

Source: MoRTH⁵²

⁵¹ <https://www.energy-transitions.org/publications/the-potential-role-of-hydrogen-in-india/#:~:text=The%20demand%20for%20hydrogen%20in,with%20hydrogen%20from%20fossil%20fuels.>

⁵² <https://morth.nic.in/sites/default/files/Road%20Transport%20Year%20Book%202016-17.pdf>

After analysing the factors that determine the speed of road transport transition in India and the future role of new electric vehicles therein, we have framed new technology penetration scenarios till 2050 to assess the electricity demand of this sector. We developed a comprehensive road transport model that considers two primary services – passenger vehicles, including two-wheelers, three/four-wheelers, buses, and freight segments. We further segregated each primary service based on the technology of drive trains such as IC engines (ICE), battery electric vehicles (BEV), and fuel cell electric vehicles (FCEV). The IC engines are further sub-categorized based on broad energy categories, i.e., petroleum fuels and natural gas.

Further, we developed a primary segment-wise stock model that considers the existing stock and the future projection and assumes ownership over time and saturation levels. For example, the four-wheeler ownership in India is expected to grow from 23 cars per thousand population in 2016 to 127 cars per thousand population by 2050. The rate of four-wheeler ownership in India is still far less than in the United States (349 cars per thousand population), Japan (479 cars per thousand population), and the United Kingdom (470 cars per thousand population). We also assume that the two-wheeler ownership will rise faster, from 128 per thousand population in 2016 to 302 per thousand population by 2050, driven by the relative affordability of two-wheelers compared to four-wheelers and an increase in per capita income. In the case of freight vehicles, we assume that the stock ownership would rise to 37 per thousand population and buses to 3 per thousand population.

In each category, we assume the lifetime of vehicles to represent the on-road active stock. The other key assumptions around operating parameters such as annual vehicle kilometers, mileage, and efficiency improvements are also considered. For example, we assume that the vehicle activity for inter-city buses would be 200 km per day, compared to 100 km per day on an average for intra-city transport. Similarly, for freight vehicles, we assumed light-duty trucks would travel 50 km per day compared to heavy-duty trucks that travel 200 km per day on average. This approach is followed for other vehicle categories as well. There is considerable uncertainty in the stock mix by weight (typically trucks ranging from 3.5 tonnes to over 50 tonnes) and activities. For the study, we have pooled together the LDV and HDV

Table 12: Assumptions on vehicle operating parameters (in kWh/100 km)

Segment (life time)	Annual distance covered (km)	Occupancy/ Tonnage	ICE (kWh /100 km)	BEV (kWh/100 km)	FCEV (kWh/100 km)
Two-Wheelers (8 years)	5500	1.5 passengers	48	6	-
Three/Four-Wheelers (10 years)	13,000	2.5 passengers	80	17	-
Buses (15 years)	45,000	25 passengers	222	120	199
Trucks (15 years)	40,000	9 tonnes	222	70	208

Source: TERI assumptions



segments into one freight category and intra-city and inter-city bus segments into the bus category and considered the weighted average in operational parameters.

Considering the total cost of ownership, policies, and other associated parameters such as infrastructure development and consumer perception on vehicles, segment-wise and category-wise projected vehicle stocks were segregated based on scenarios to reflect the share of new technologies expected to be a significant part of new sales.

As per a recent TERI study,⁵³ the total cost of ownership (TCO) analysis suggests that in the passenger vehicle categories, especially two-, three-, four-wheelers, and intra-city buses, electric vehicles could compete with both conventional and natural gas-driven vehicles by 2030.

In the long-haul bus segment, liquefied natural gas (LNG) vehicles are still expected to dominate in the short to mid-term, and fuel-cell vehicles are expected to dominate in the long-term. In the freight segment, the light-duty vehicles would be dominated by electric vehicles from mid-term to long-term, and fuel cell vehicles and battery electric vehicles are expected to dominate the heavy-duty segment in the long-term.⁵⁴ The precise balance between various technology options also depends on battery density, charging speed, infrastructure, etc., which are difficult to predict. Natural gas vehicles compete with other conventional vehicles, but their share is expected to shrink as BEV and FCEV get more attractive, much stronger in light-end passenger vehicles. This transition would be supported further by government policies that target 30% of the new EV sales.⁵⁵ In a report, NITI Aayog and Rocky Mountain Institute (RMI) also set new ambitions of EV sales penetration, constituting 80% of two- and three-wheelers, 50% of four-wheelers, and 40% of buses by 2030.⁵⁶ The Shell-TERI Net Zero Emissions 2050 report suggests that all of the two- and three-wheelers by 2030 and heavy passenger vehicles by 2050 should be electric to achieve net-zero.⁵⁷

Considering all the existing trends and driving factors together, we framed the 'baseline' and the 'low carbon' scenarios to reflect the expectations and uncertainty in penetration of new energy technologies in new EV sales adequately. The 'baseline' scenario may seem a little ambitious for light end passenger segments; however, agrees largely with stakeholder perception. In the case of the freight segment, the penetration level considered may be called 'cautiously optimistic' to 2030 and 'optimistic' post 2030, especially in the truck/freight segments. Given the global pressure on countries for climate action, this could be possible, especially to achieve net-zero by mid-century. In the case of rail traction, the electricity demand is projected using an econometric approach based on the robust relationship of ($R^2=0.97$) with total GVA. The assumptions regarding EV penetration share in new vehicles are given in Figure 13.

⁵³ <https://www.teriin.org/project/roadmap-electrification-urban-freight-india>

⁵⁴ <https://www.energy-transitions.org/wp-content/uploads/2021/04/ETC-Global-Power-Report-.pdf>

⁵⁵ <https://www.financialexpress.com/auto/car-news/government-finally-wakes-up-sets-a-realistic-goal-of-30-electric-vehicles-by-2030-from-existing-100-target/1091075/>

⁵⁶ <https://rmi.org/wp-content/uploads/2019/04/rmi-niti-ev-report.pdf>

⁵⁷ <https://www.teriin.org/press-release/net-zero-emissions-indias-energy-system-2050-technologically-possible-highly>

Transport scenario

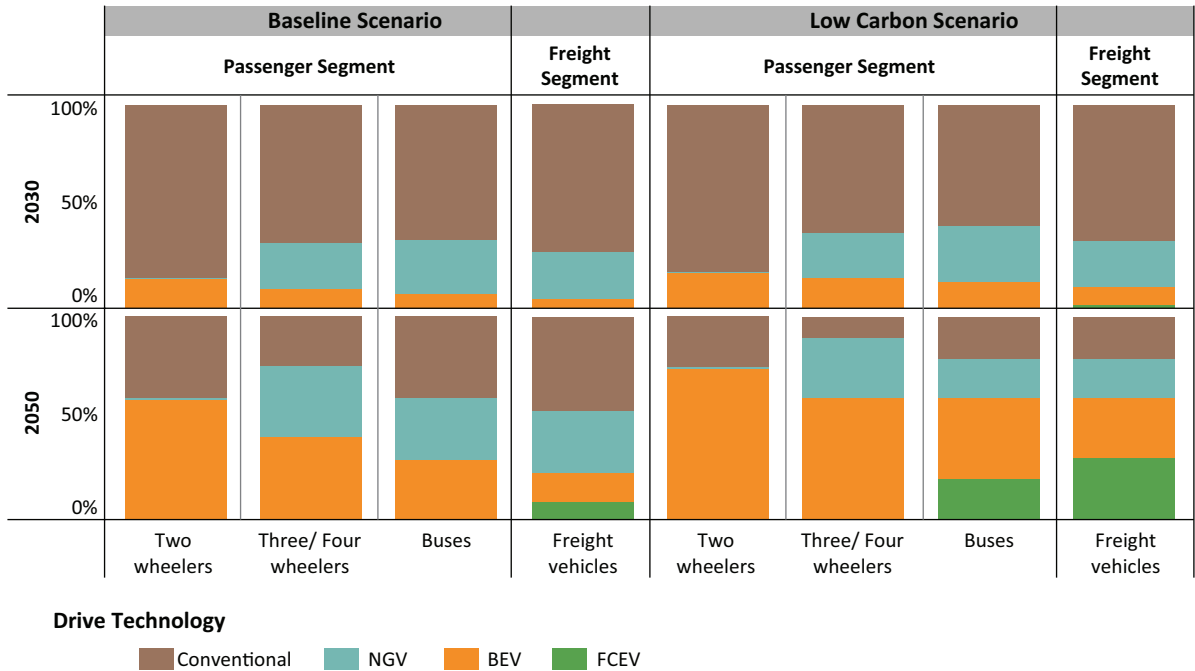

Figure 13: Scenario for new energy vehicle penetration in yearly vehicle sales

Source: TERI analysis

Results

We estimated that the passenger activity would increase by nearly four times, reaching 21,273 billion PKM by 2050, and freight activity nearly by five times, reaching 17,127 billion TKM from 2018 levels.

Further, we estimated that the total road transport energy demand would increase at the rate of 4.4% to 4.2% per annum till 2050, reaching 403 Mtoe and 451 Mtoe in baseline and low carbon scenarios, respectively. The energy demand from freight activity is assumed to grow much faster, at the rate of 5% compared to the growth rate of 3% and 3.4% assumed with respect to passenger vehicles in baseline and low carbon scenarios, respectively. This is due to the faster transition of the passenger vehicles segment to electric vehicles. It is to be kept in mind that the total energy demand encompasses all energy sources, including gasoline, diesel, hydrogen and electricity. We estimate that the electricity requirement for road transport will increase to 456 TWh and 773 TWh by 2050 in baseline and low carbon scenarios, respectively. The railway traction electricity demand is expected to increase to 72 TWh from 17 TWh in 2018. This may be biased towards the lower side while considering the policies to completely electrify rail traction by 2024.⁵⁸ Overall, the transport sector is estimated to increase its share in total electricity demand, reaching from the present level of ~1% to 3%-5% by 2030 and 11%-19% by 2050. The key results are shown in Figure 15.

⁵⁸ <https://m.economictimes.com/industry/transportation/railways/railways-to-run-100-on-electricity-by-2024-says-goyal/articleshow/73683657.cms>



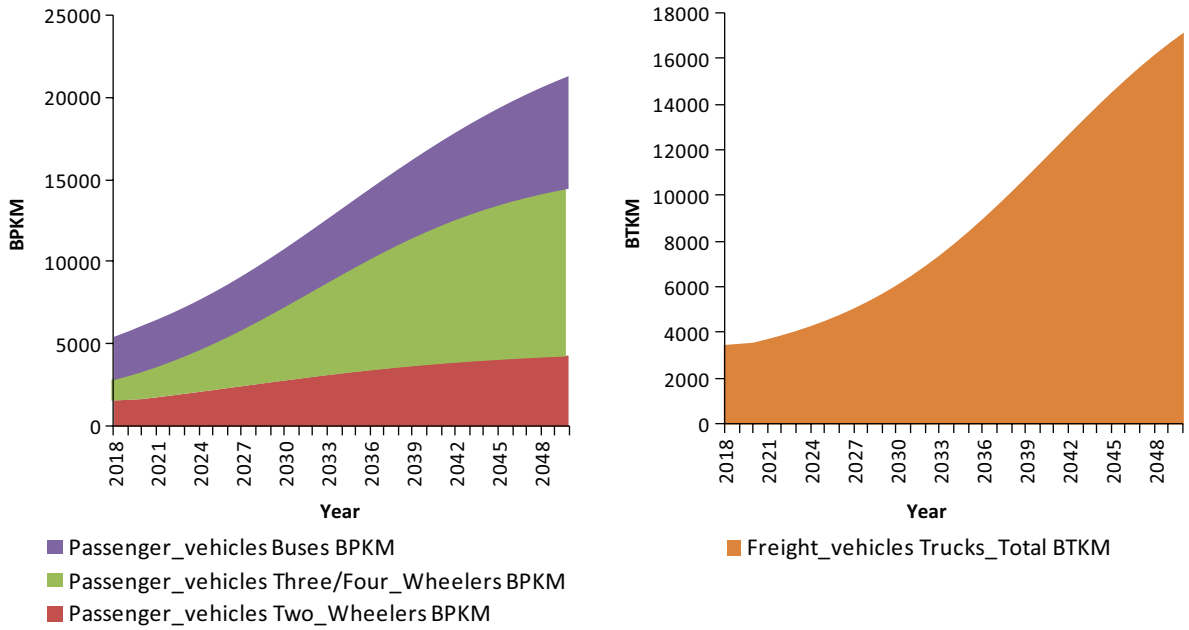

Figure 14: Projection results for passenger and freight activity demand up to 2050
Source: TERI analysis

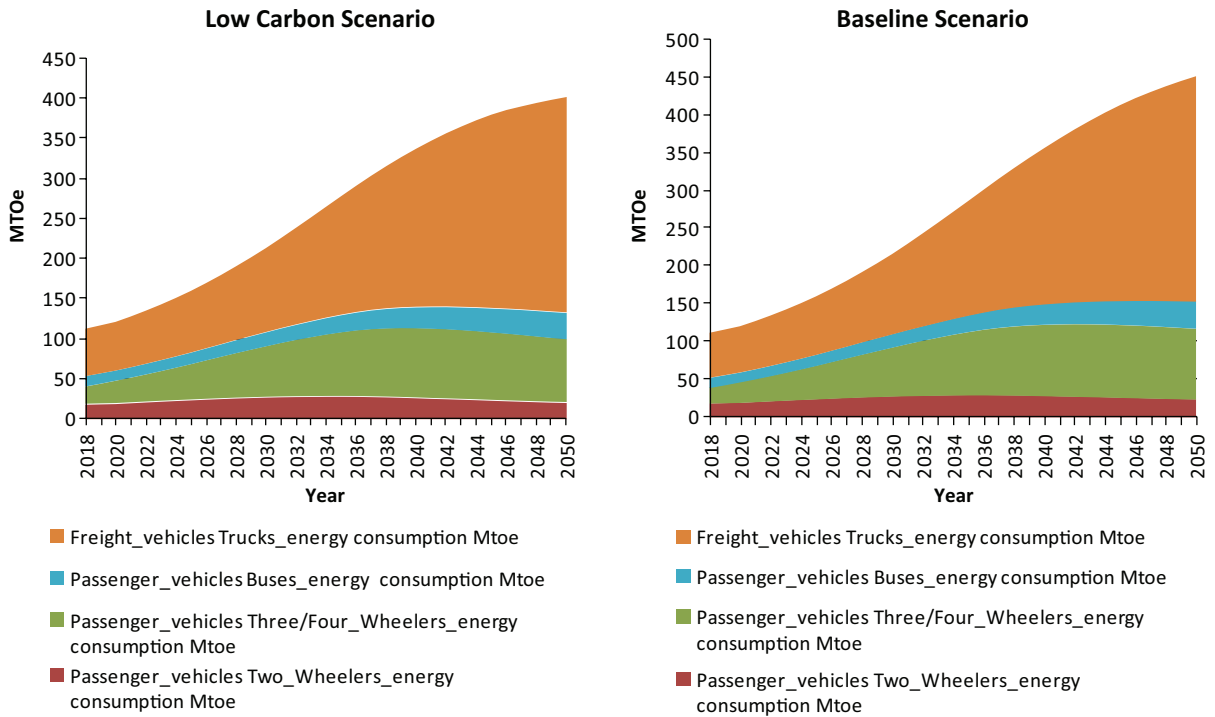

Figure 15: Results of total transport energy demand under Low Carbon and Baseline scenarios
Source: TERI analysis

Table 13: Summary of transport sector demand analysis and projections

Scenario	Direct electrification demand for road transport (TWh)		Electricity demand for rail transport (TWh)		Total electricity demand in the transport sector (TWh)	
	2030	2050	2030	2050	2030	2050
Baseline	34	456	35	72	70	528
Low Carbon	52	773	35	72	90	845

Source: TERI analysis

3.2.6 Hydrogen

Across the world, green hydrogen is regaining importance as a potential zero-carbon fuel option to replace the existing fossil-based fuels and feedstocks used in industries and transport. The key factors driving its popularity are the likely fall in the cost of green hydrogen, strengthening global policies and mandates, and increasing demand.

Presently, India accounts for 8.5% of the global hydrogen demand,⁵⁹ consuming 6 MT of grey hydrogen each year. Most of the hydrogen used as feedstock is in fertilizers, refineries/petrochemical industries, etc. In a recent TERI report,⁶⁰ the future role of green hydrogen has been extensively studied in the Indian context. Figure 16 shows the projection of hydrogen demand categorized by its source to 2050. In Industries, as per the study, hydrogen could play a role as a long-term storage vector, absorbing excess electricity during certain periods of the years to be used again at times of sustained low renewable output. This only becomes a necessary option of managing grid variability at high penetrations of variable renewables in the total generation, i.e., above 60-80% of the total generation, which is unlikely until

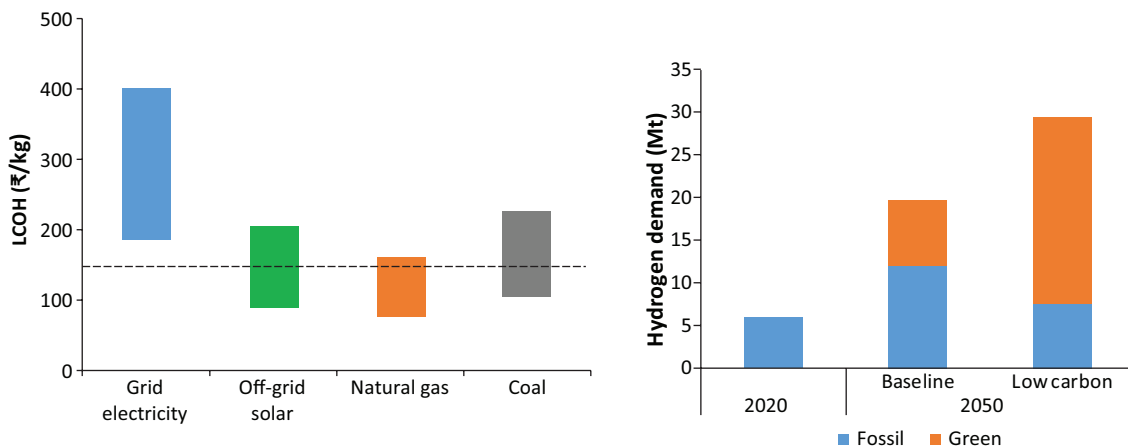

Figure 16: Cost reduction potential of various hydrogen production pathways and hydrogen demand estimated based on production source

Source: Will Hall, *et al.*,⁶¹ TERI analysis

⁵⁹ <https://indianexpress.com/article/opinion/the-path-to-a-hydrogen-economy-7369262/>

⁶⁰ <https://www.energy-transitions.org/publications/the-potential-role-of-hydrogen-in-india/#:~:text=The%20demand%20for%20hydrogen%20in,with%20hydrogen%20from%20fossil%20fuels.>

⁶¹ <https://www.teriin.org/sites/default/files/2020-12/Report%20on%20The%20Potential%20Role%20of%20Hydrogen%20in%20India%20%E2%80%93%2027Harnessing%20the%20Hype%27.pdf>

around 2040. The overall demand potential is estimated to be in the order of 14.5 MT to 22 MT in baseline and low carbon scenarios, respectively, by 2050. Out of this, green hydrogen could contribute anywhere between 6 MT and 16 MT. Similarly, for transport, the green hydrogen demand is estimated to be in the order of 6MT and 8 MT.

Around 896 TWh of green electricity at less than Rs 1.40/kWh would be required to produce 20 MT of cost-competitive green hydrogen as per the low carbon scenario, requiring ~340 GW of RE capacity to be deployed at high potential sites (@30% CUF). Also, this capacity needs to be in the form of off-grid RE plants, as grid electricity would be costlier (Rs 6-7/kWh) for industrial consumers, which reduces the competitiveness of hydrogen. Though it is likely to impact capacity planning, we do not consider the hydrogen electricity demand and exclude it from the grid electricity demand.

3.3 Total Demand Projections

The total on-grid electricity demand is estimated to grow at 4.9% and 4.6% in baseline and low carbon scenarios from 1210 TWh in 2019. In other words, the per-capita grid electricity consumption is projected to increase to 2700 kWh and 2643 kWh by 2050 in baseline and low carbon scenarios from the present level of 1181 kWh (in 2019). The energy-generation requirement (ex-bus) is estimated to be between 5246 TWh and 4985 TWh in baseline and low carbon scenarios, respectively, in 2050. This is attributed to significant improvement in transmission and distribution (T&D) losses, which are estimated to come down significantly from 21% today to 12%, much closer to the world average. The aggregate on-grid demand projections under various scenarios are shown in Figure 17.

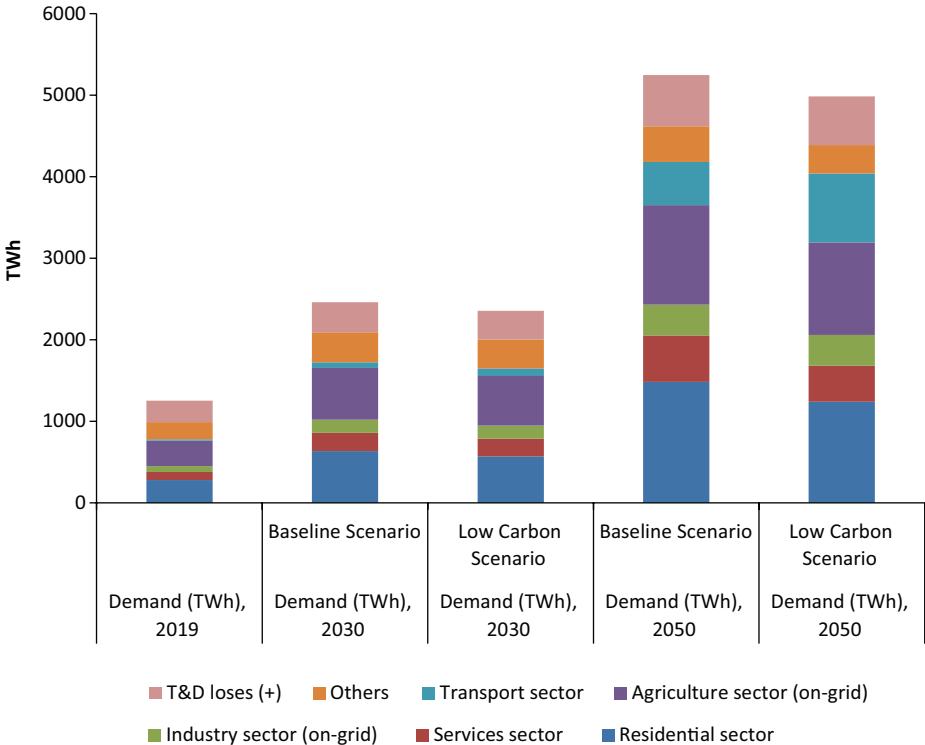

Figure 17: Summary results of total grid electricity requirement

Source: TERI Analysis

Load Profile Estimation and Peak Demand

Consequent to the assessment of total electricity demand requirement (ex-bus) at the national level, the electricity demand was spatially disaggregated to the regional level. The regional share in total demand for future years was estimated by considering anticipated growth rates in individual regions based on historical growth rates, adjusted to meet the projected all-India electricity demand.

Subsequently, the estimated annual regional demand was converted in hourly regional load profiles taking the hourly demand data collected from Power System Operation Corporation Limited (POSOCO) for 2017–18 and considering the trend in load factor to be in line with the 19th EPS.⁶² For the baseline demand scenario, the expected peak requirement at the national level is estimated to be 750 GW by 2050. In contrast, for low-demand (low carbon scenario) sensitivity, the peak demand requirement is 700 GW.

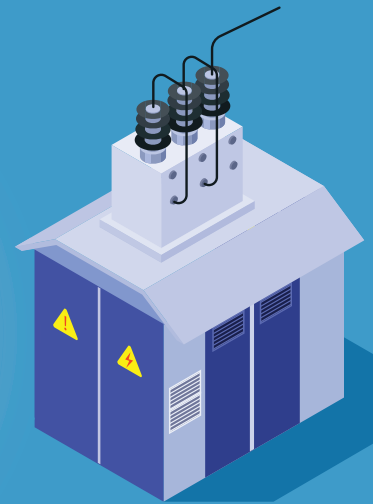
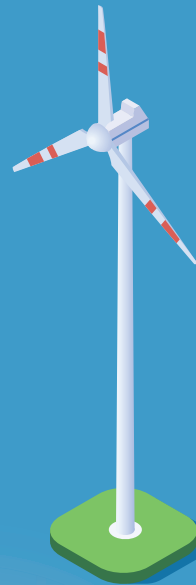
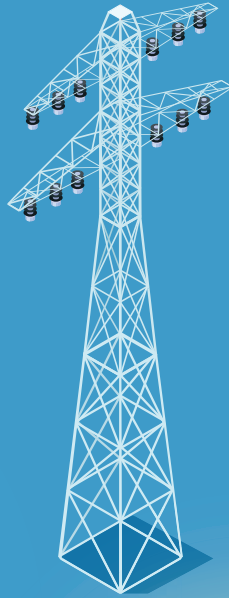
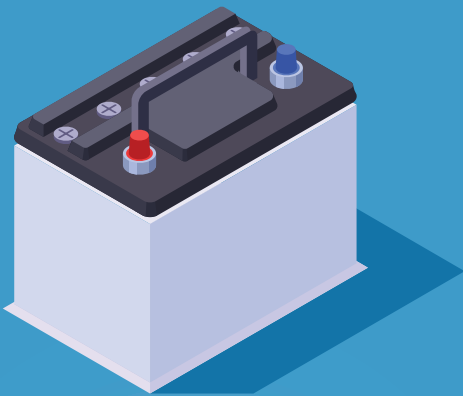

Figure 18: Annual demand curves for 2019 and 2050 baseline scenario (demand in MW)

⁶² Load factor of 0.77 in FY2036-37 as per 19th EPS, in the study load factor of 0.80 consider to calculate peak requirement.



4. Technology-specific Constraints



4.1 Technology-specific Constraints for Capacity Expansion

Coal-fired capacity: Most of the pithead coal plants are located in India's Eastern and Southern regions due to the availability of coal reserves in the same. While a capacity limit of 85 GW (10 GW in Northern, 15 GW in Southern, and 30 GW in Eastern and Western each) of pithead coal-based generation capacity is assumed due to site suitability constraints, no such limit is assumed for non-pithead-based generation capacity. Also, an extension of the existing power purchase agreements (PPAs) by 12 years is taken to portray the operational lifespan of a thermal power plant. However, the operational lifetime for new coal-generation capacity was assumed to be 25 years.

Nuclear capacity: In India, the growth of nuclear power is highly sensitive to policy and safety concerns. Since the introduction of nuclear technology, India has only 6.7 GW of existing capacity and around 15 GW of planned capacity. The model considered two technology types, namely pressurized heavy water reactor (PHWR) and light water reactor (LWR), with maximum capacity addition of 7000 MW in every five-year timestamp from 2025.

Solar and wind resource potential: India's ground-mounted solar PV potential, as estimated by the National Institute of Solar Energy (NISE), is 748 GW,⁶³ and total on-shore wind potential, as estimated by NIWE, is 695 GW⁶⁴ at 120 m above ground level (AGL), including 340 GW potential in wastelands, 347 GW on cultivable land, and 8 GW in forested areas. The study considers investments in only on-shore wind technology due to the limited availability of data on off-shore wind potential and resource characteristics. Table 14 shows the region-wise solar PV and wind potential as considered in the study.

Table 14: Region-wise solar PV and wind potential (in MW) in India considered in the study

Technology	ER	NER	NR	SR	WR	All India
Solar PV Ground Mounted	61420	62300	336250	107330	180900	748200
Wind On-shore	14323	521	128762	295370	256533	695509

Hydro capacity constraints: Considering the long gestation period and current pipeline capacity targets, we assume a ceiling of 10 GW on the capacity addition of hydro in each 5-year time block commencing from 2025.

⁶³ <https://pib.gov.in/PressReleaseDetailm.aspx?PRID=1754477>

⁶⁴ https://niwe.res.in/assets/Docu/India's_Wind_Potential_Atlas_at_120m_agl.pdf



Pumped hydro addition: Pumped hydro is a capital-intensive technology but generally has a longer life (80 years) than other energy storage technologies. India has a total of 103 GW of pumped hydro potential,⁶⁵ but only 5 GW has been built so far.

Pumped hydro has a longer gestation period, and in view of this and the past record of its development, we consider a conservative capacity addition limit of 2.5 GW in every five-year time interval in the baseline scenario.

4.2 Technology-specific Constraints for Electricity Generation

Solar and wind CUF: We assume a marginal improvement in PV module efficiency and consider that all new solar PV plants by the year 2025 would have single-axis tracking, resulting in a CUF of the order of 26–28% by 2050. Similarly, all-new wind power generators are assumed to be built at a hub height of 120 m (CUF range being 28%–35%).

Domestic gas availability: The total domestic gas allotted to the power sector in 2018 was ~87.12 MMSCMD, but only 25.11 MMSCMD was supplied.⁶⁶ In the absence of an indication of the availability of domestic gas, in the long run, we assume that the quantity of domestic gas supplied today will remain unchanged till 2050 at the projected price for domestic gas.

In the case of imported gas, we have not considered any supply/availability constraints due to the adequate capacity to import gas. Since the model does not pick up new gas generation capacity, the capacity of LNG terminals for regasification is not considered in this study. The higher cost of imported gas, however, limits the build-up of gas-based generation capacity that relies on imported gas.

Cost of unserved energy: The modelling framework under the study seeks to meet 100% demand and avoid any unserved load. As a result of this, the model builds generation capacity up to the last kWh requirement, which leads to a high degree of unutilized generation capacity. To avoid such a build-up, we put a cost on the unserved load of Rs 20/kWh.⁶⁷

⁶⁵ https://cea.nic.in/wp-content/uploads/2020/04/hydro_develop_12th_plan.pdf

⁶⁶ Standing committee on Energy (2018-19) 42nd report.

⁶⁷ https://cea.nic.in/old/reports/others/planning/irp/Optimal_mix_report_2029-30_FINAL.pdf, Page 49

5. Capacity Scenarios



The supply side scenarios analysed in the report are designed considering the RE addition limit and generator retirement. The details of capacity scenario assumptions, technology build-up, and operational constraints are discussed in the subsequent sections.

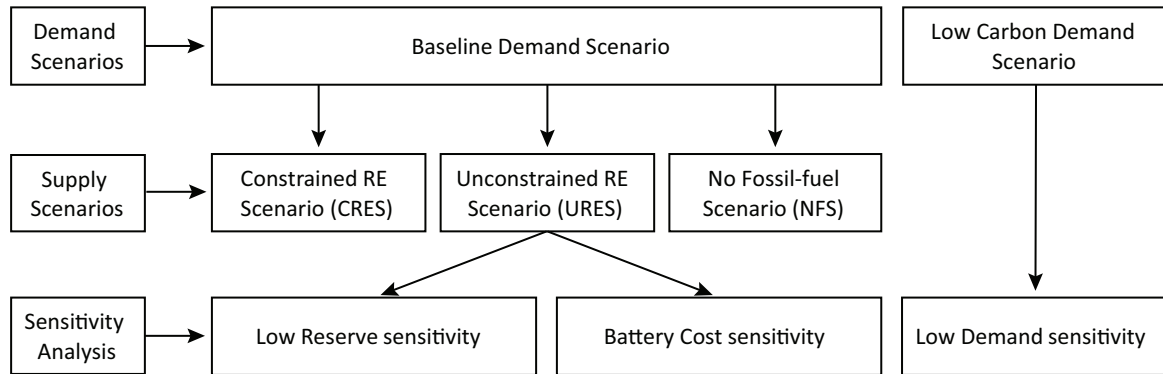

Figure 19: Demand and capacity scenario architecture

5.1 Constrained RE Scenario (CRES): Least Cost Optimal Capacity with bounds on RE Potential

India's ambitious RE capacity addition targets will require high resource potential land. The estimated RE potential for solar PV and on-shore wind is 748 GW and 695 GW, respectively. However, estimates of potential from other sources are much higher.⁶⁸ Few studies have also analyzed India's land requirement to attain net-zero by mid-century which is estimated to be around 50,000-75,000 km² for solar PV, and 15,000-20,000 km² area for wind,⁶⁹ which is approximately 3% of the total land. Thus, identifying the land for installation of solar and wind plants is extremely important. We wish to study this critical parameter guiding India's high RE transition by mid-century. Therefore, the VRE potential limit considered in CRES, equal to the assessment by NISE and NIWE, is relaxed in URES and NFS.

5.2 Unconstrained RE Scenario (URES): Least Cost Optimal Capacity without Bounds on RE Potential

Achieving India's RE goals will require massive solar PV and wind power plants by mid-century. Various studies have showcased a higher degree of RE potential, exceeding the estimates by MNRE and NIWE. This scenario helps understand the quantum of RE-based capacity required to transition towards a carbon-neutral power sector. In the URES, we do not enforce the capacity constraint limits estimated

⁶⁸ <https://www.nrel.gov/docs/fy20osti/76153.pdf>

⁶⁹ http://ieefa.org/wp-content/uploads/2021/09/Renewable-Energy-and-Land-Use-in-India-by-Mid-Century_September-2021.pdf



through MNRE on solar PV and on-shore wind potential, therefore providing a broad understanding of regional land requirements for the deployment of solar PV and wind in the least-cost pathway. All the other assumptions in this scenario are as per Sections 2, 3, and 4.

5.3 No Fossil-fuel Scenario (NFS)

This scenario provides insights into a plausible future for India's electric power system, considering no new build-up of fossil-based generation capacity after 2025. As coal-based generation has an economic lifetime of 25 years, any capacity addition in 2025 would retire by 2050. This scenario also demonstrates a case to analyse various operational challenges involved in the complete decarbonization of the Indian power sector by mid-century and gain insights into the role of different technologies in balancing high RE.

Table 15: Scenario description on RE potential and fossil-based capacity limit

Scenarios	Renewable Energy Potential	Fossil-Fuel based Generation capacity build-up
Constrained RE Scenario (CRES)	Limited by resource potential estimated by NISE and NIWE	Pithead coal plant capacity addition constraint as described in Section 4.1
No Fossil-fuel Scenario (NFS)	2000 GW-Solar 1500 GW-Wind	No new capacity build-up after 2025
Unconstrained RE Scenario (URES)	No limit on solar and wind potential	Pithead coal plant capacity addition constrained as described in Section 4.1

5.4 Sensitivities

Apart from the three capacity scenarios, we analysed results taking sensitivity assumptions around a lower electricity demand, lower reserve margin requirements, and battery costs. The sensitivities are discussed in detail in Section 7 of the report. All the other assumptions besides the sensitivity variables are same as the ones considered in the URES.

6. Results of the Study



In this section, we present an overview of the aggregate results of all the scenarios (see Section 5). Table 16 shows the summary of the results across all scenarios. These scenarios consider the baseline demand, with a total energy requirement of 5246 TWh and a peak demand of 750 GW in 2050.

Table 16: Summary of aggregate capacity, generation, and grid emission intensity in CRES, URES, and NFS

Year	CRES				URES			NFS		
	2020	2030	2040	2050	2030	2040	2050	2030	2040	2050
Installed capacity (GW)										
Coal	205	225	215	247	225	216	169	176	69	0
Gas	25	14	3	21	14	3	2	13	2	0
Hydro ^{\$}	51	45	46	65	45	46	44	57	58	57
Nuclear	7	12	17	42	12	10	10	18	19	18
Solar	35	220	658	748	220	608	1472	230	789	1839
Wind	38	164	367	694	164	456	421	167	424	368
Pump Hydro	5.75	5.75	5.75	5.75	5.75	5.75	5.75	5.75	8.8	8.8
Total*	367	686	1308	1828	686	1345	2124	667	1370	2291
Ex-bus generation (TWh)#										
Coal	994	1397	962	1216	1396	859	422	1290	477	0
Gas	49	30	21	42	29	19	7	51	8	0
Hydro	166	150	161	217	151	163	138	192	203	173
Nuclear	47	73	106	247	74	67	57	111	118	107
Solar	50	390	1450	1701	391	1323	3406	393	1720	3944
Wind	65	420	1064	1823	420	1334	1215	423	1238	1022
Total	1370	2460	3765	5246	2460	3765	5246	2460	3765	5246
Battery storage capacity										
Capacity (GW)	0.0	4.0	207.5	379.5	4.0	167.4	864.2	49.6	306.5	1169
Storage hour	0.0	1.0	5.6	6.0	1	6.1	6.0	5.4	5.9	6.1
Grid Emission factor										
kgCO ₂ /kWh	0.71	0.55	0.25	0.22	0.54	0.21	0.07	0.50	0.12	0.00

For the year 2020, the presented figure is Gross generation excl. Biomass. For years 2030, 2040 and 2050 results are ex-bus generation and normalized for the whole year.

\$ Including small hydro

*Excluding W2E and biomass capacity of 12 GW.



6.1 Installed Capacities

The results suggest that the installed capacity required would be 4.8 to 6.2 times of the present capacity levels, reaching 1828 GW, 2124 GW, and 2291 GW in CRES, URES, and NFS, respectively by 2050. The share of VRE capacity will be 79%, 89%, and 96% in CRES, URES, and NFS scenarios, respectively, by 2050 from ~20% in 2020.

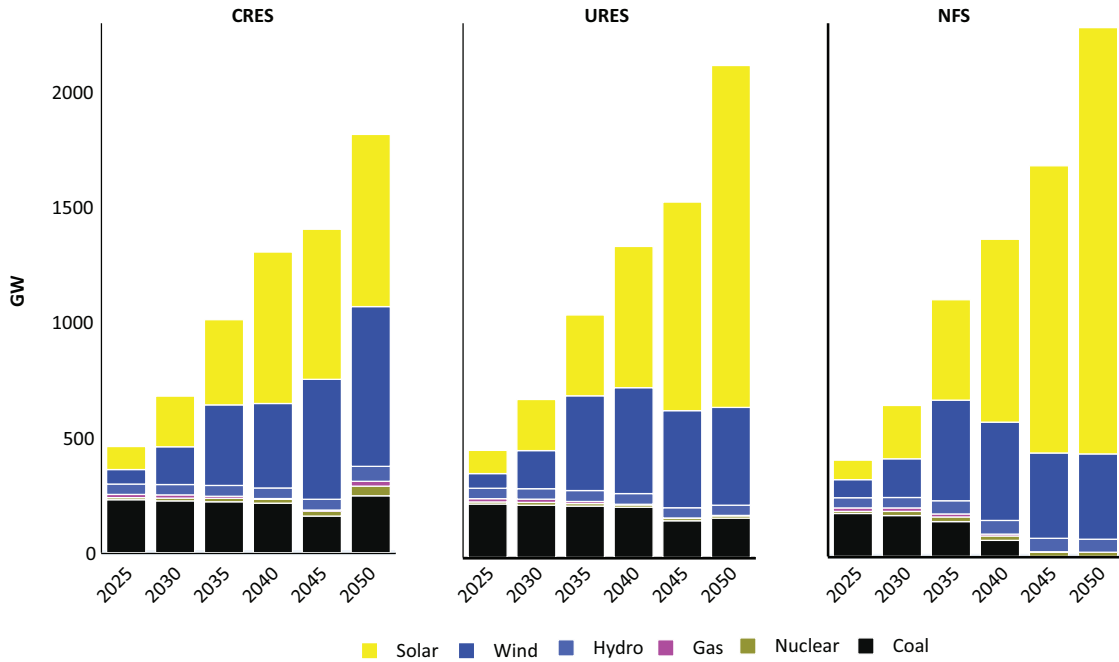

Figure 20: Technology-wise installed capacity by 2050

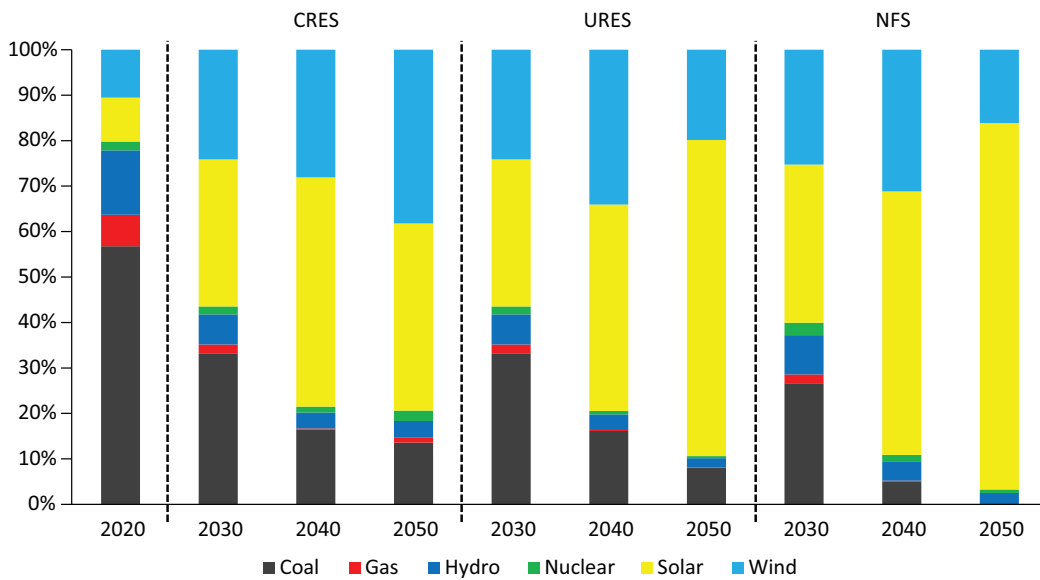

Figure 21: Technology-wise capacity share in total capacity mix

The factors that strongly influence the build-up of solar PV and wind capacity are the capital cost trajectory and the potential of solar PV and wind which can be harnessed. In the CRES, the presently assessed potential of solar PV will be exhausted by 2045. Consequently, the wind capacity build-up will increase to its assessed potential by 2050, resulting in new coal, gas, hydro, and nuclear capacity build-up to meet the residual electricity demand from 2045. Between 2045 and 2050, the net capacity addition of coal and gas (considering retirement) in the CRES is 47 GW and 23 GW, respectively. However, in URES and NFS, the resource potential is increased to a higher limit of 2000 GW (Solar PV) and 1500 GW (Wind), resulting in a greater build-up of solar PV capacity.

Solar PV is estimated to dominate the total generation capacity mix across scenarios, constituting ~ 40% of the capacity by 2050, even in the CRES. The share of solar PV in the total generation capacity in the URES and NFS is much higher at 70% and 80%, respectively. An important factor influencing the build-up of solar PV capacity is the decline in BESS costs after 2035. Across scenarios, the BESS storage capacity increases from a relatively low level of 4 GW (1 h duration) in 2030 to a maximum of 1169 GW (6 h duration) in the NFS by 2050, with 379 GW in the CRES and 864 GW in the URES (both ~6h duration) by 2050. As no new fossil fuel capacity is being added in the NFS, the BESS capacity increases to 1169 GW to enable a relatively high level of solar PV integration. In contrast to the other scenarios where there is no new addition of pumped hydro storage capacity, the pumped hydro storage capacity increases marginally to 8.8 GW by 2050 from 5.7 GW in 2030 in the NFS.

Region-wise Solar- and Wind-Installed Capacities

The scenario-wise build-up of solar PV and wind capacity by 2050 is shown in Figures 22 and 23, respectively. At the regional level, this build-up varies based on load profiles and resource availability constraints; if solely based on the level of irradiance and regional load, the NR would dominate. Across the scenarios, the NR dominates the solar PV capacity build-up compared to other regions due to the relatively high electricity demand and higher irradiance sites.

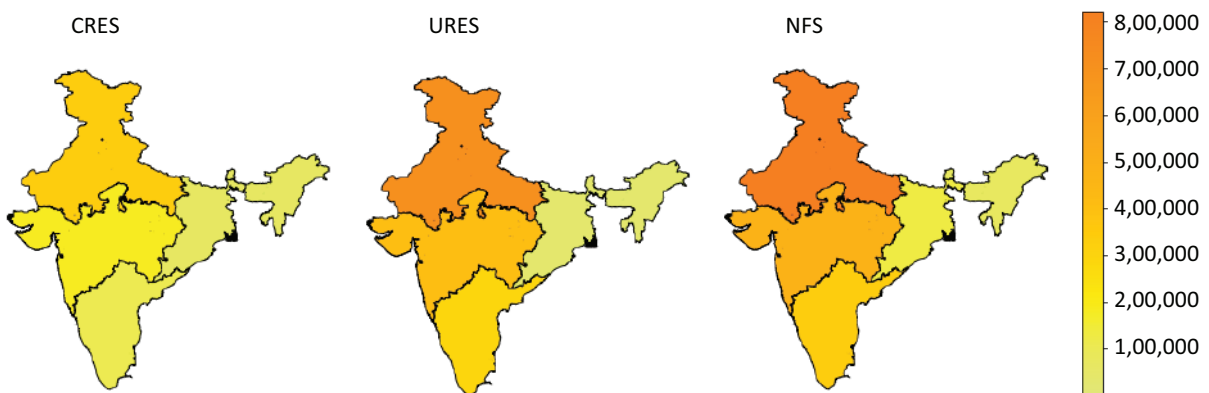
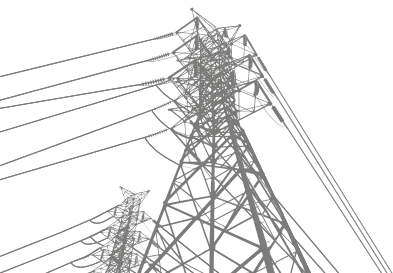

Figure 22: Regional solar capacities (MW) in CRES, URES, NFS in 2050



In the CRES, Southern Region (SR) dominates the wind capacity additions followed by Western Region (WR) (with CUF ranging between 28% and 35% at 120 m height). However, after 2035, the model builds more solar PV and storage capacity in other scenarios than wind capacity. solar PV and storage capacity additions dominate after 2035 due to cost competitiveness, limiting the usefulness of wind to a certain level. Still, wind capacity remains dominant in the total VRE mix in certain regions, such as the WR and SR.

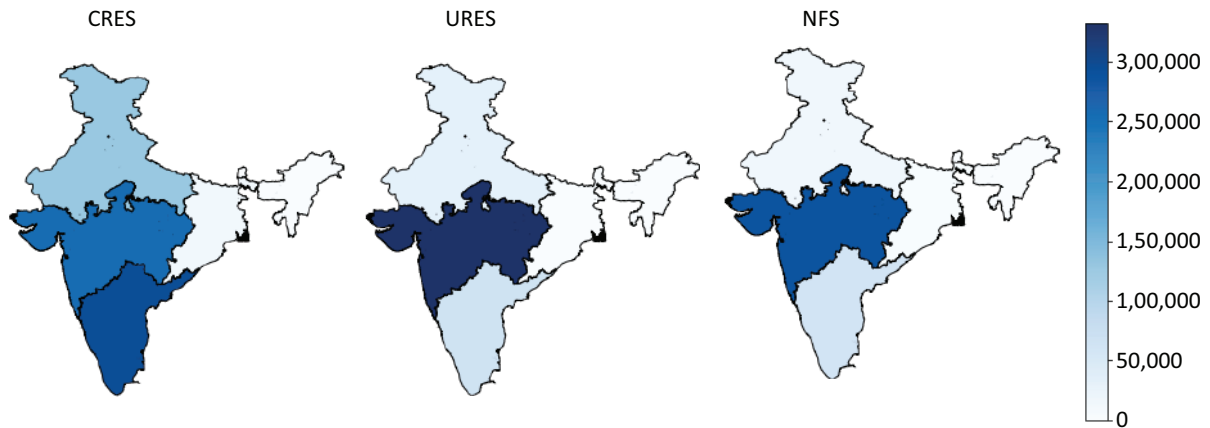

Figure 23: Regional wind capacity (MW) in CRES, URES, NFS in the year 2050

Coal-based Generation: New Addition and Retirement

Figure 24 represents pithead and non-pithead coal-based generation capacity addition and retirement in each five-year block till 2050 (For assumptions on the addition of coal-based capacity, refer to section 4.1). In the CRES and URES, aggregate coal-based generation capacity addition will reach 149 GW and 73 GW, respectively, by 2050. Pithead coal-based generation capacity accounts for 75% and 96% of the total coal capacity in the CRES, and so in the URES, non-pithead is not viable.

The cost competitiveness of pithead coal plants in terms of variable cost makes these plants run at a higher plant load factor (PLF) than non-pithead plants, thereby making the build-up of pithead coal plants cost-optimal, at least in the initial years. However, between 2030 and 2050, there is an addition of only 6 GW of pithead coal-based capacity in the URES. Due to the limit on RE potential and the limit on pithead coal-based generation capacity, new non-pithead coal capacity is required in the CRES to meet the residual demand. In the NFS, the capacity addition for all coal power capacity is restricted after 2025, allowing the retirement of the entire coal fleet by 2050. Around 192 GW of non-pithead coal-based capacity retires by 2050 in the NFS, further pushing the penetration of RE generation to nearly 100%.

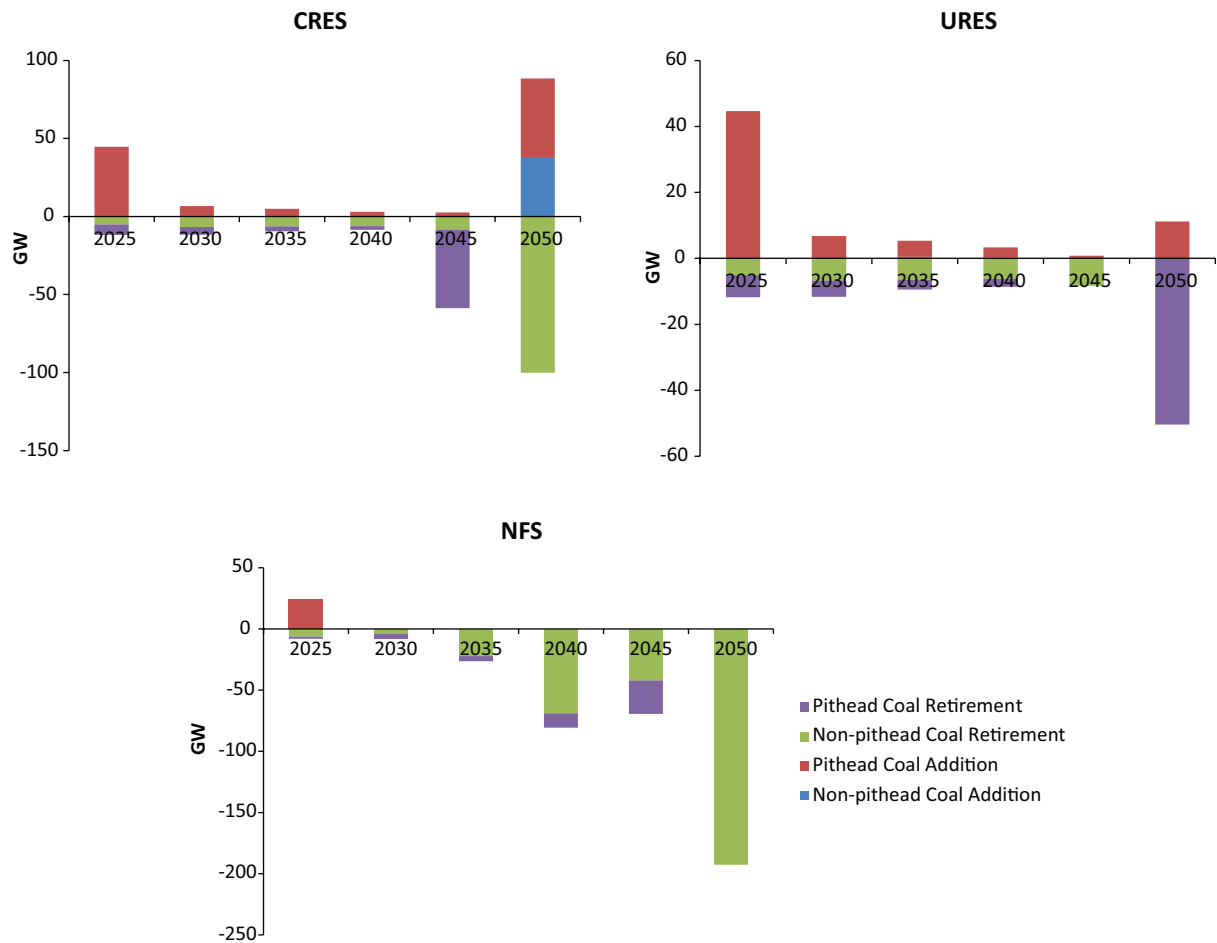

Figure 24: Addition and retirement of coal power plants in scenarios

Capacity and Duration of Battery Energy Storage System

BESS is expected to play a crucial role in integrating RE, particularly solar PV, beyond a certain penetration level. The aggressive cost projections result in a large volume of solar PV and BESS integration in all scenarios. Figure 25 shows the BESS capacity in various scenarios across the investment period. By 2050, the BESS capacity reaches a maximum of 1169 GW (7130 GWh) in NFS and a minimum of 380 GW (2280 GWh) in CRES, wherein the build-up of VRE is limited. By 2030, BESS is seen to contribute to the power system during peak hours (1-2 hours). However, by 2050, a longer duration of BESS will also supply a significant portion of the baseload for ~ 6-8 hours to balance demand during non-solar hours.

The daily and seasonal balancing requirements will change according to load variation and VRE penetration; hence, BESS operation requires further deliberation.

We first examine the average charging and discharging profile through a heatmap shown in Figure 26 and the intensity of charging and discharging through a duration curve in Figure 27.



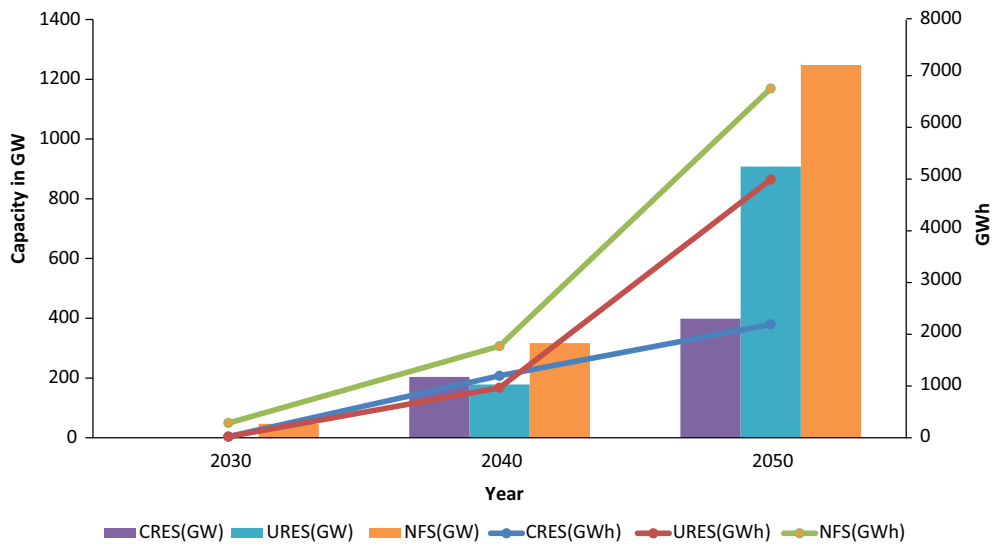

Figure 25: Battery system capacities across scenarios

Figure 26 shows the charging and discharging from BESS, represented in per-unit of the battery power capacity, across the day and month of the year in 2050 compared to 2030. The positive value on the scale represents discharging, while negative represents charging. In 2030, the BESS despatch remains scattered due to the limited daily balancing requirement. From June-August, there is a reasonably high wind generation complemented by solar PV based generation. During this period, BESS provides the flexibility required to integrate a higher level of RE generation during the daytime.

By 2050, large-scale solar PV integration will result in mid-day BESS charging, as seen in Figure 26. The charging and discharging pattern are relatively consistent across seasons and months, with minor differences during winter months. The BESS stores excess solar PV generation and supplies the same during other day hours. The charging of the BESS peaks between 1:00 to 3:00 p.m.; however, it discharges more evenly throughout the day to balance the load.

The BESS operation varies across the year, and hence, we examine the duration of this despatch. As seen in Figure 27, the charging occurs for a comparatively shorter duration (accounting for ~37% of the total duration). Still, it requires a higher power capacity to absorb a relatively large quantum of solar PV generation during the day. On the other hand, the discharging of BESS is spread out across non-solar hours; this suggests that the charging characteristics determine the energy to power ratio of the BESS.

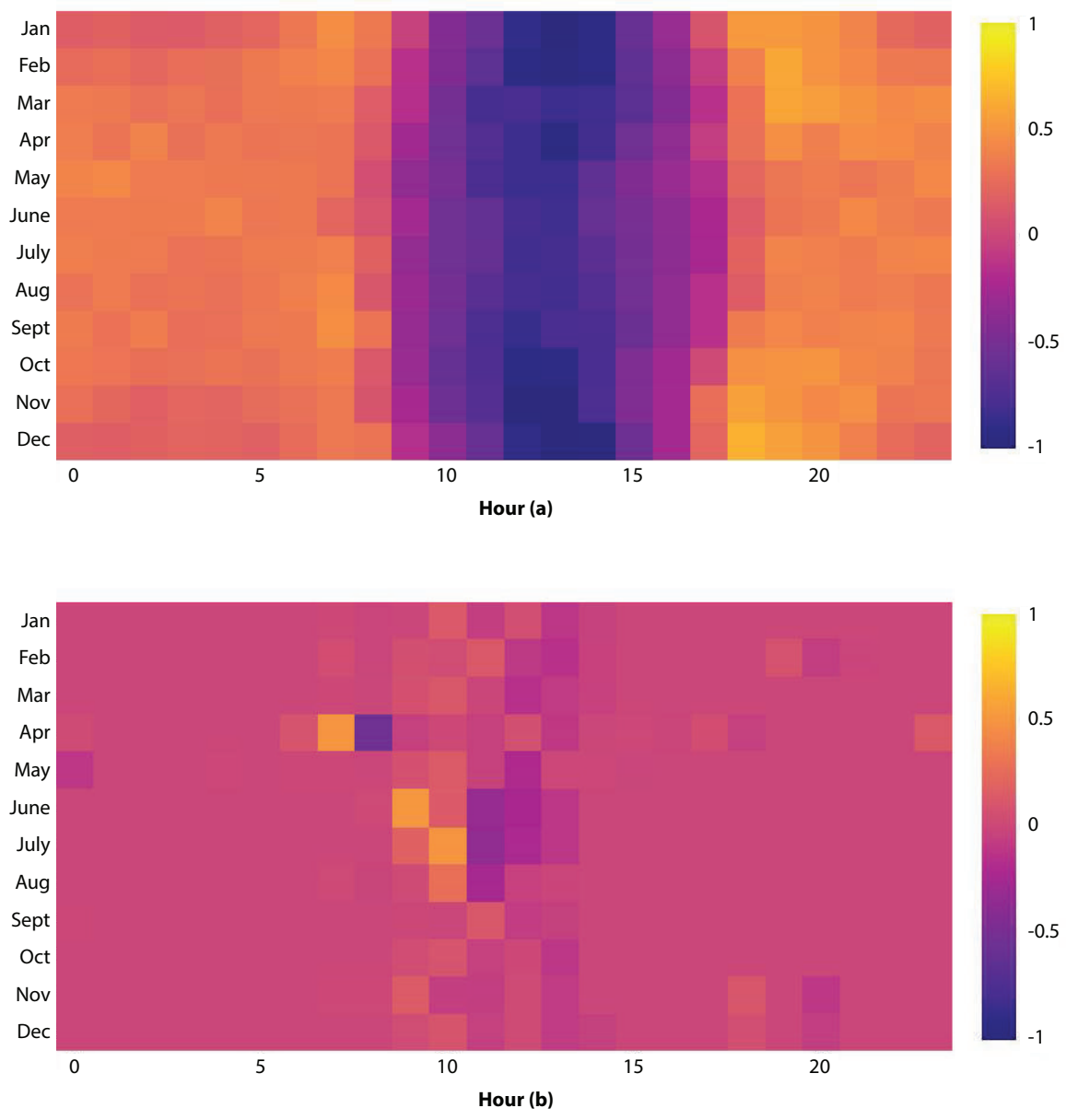

Figure 26: BESS charging and discharging profile (a) 2030, (b) 2050



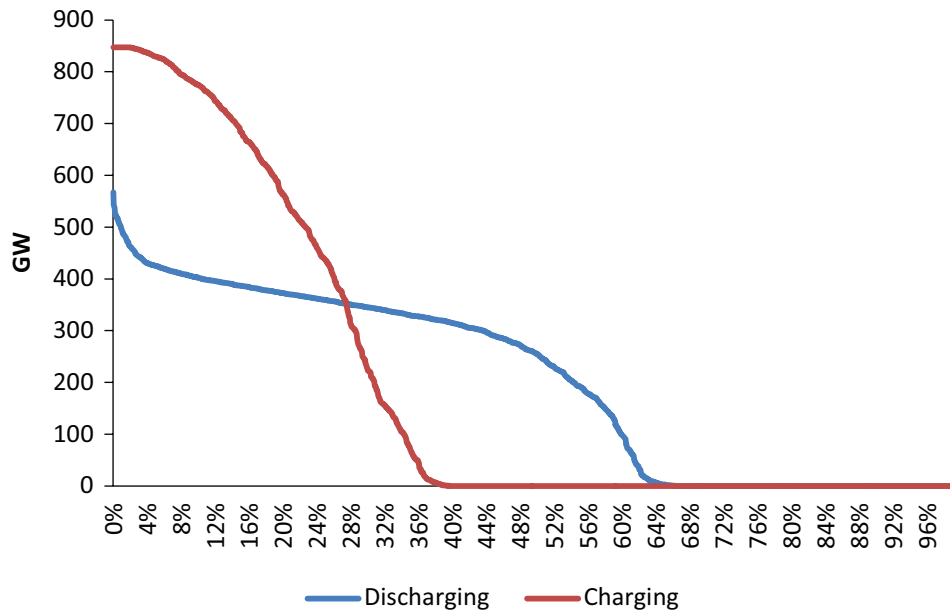

Figure 27: BESS charging and discharging duration curve

6.2 Generation Shares and CO₂ Emissions

Figure 28 shows the results of the generation mix over time. The wind and solar PV share in the total generation is estimated to increase from around 8% in 2020 to about 67% (32% solar PV and 35% wind) by 2050, in the scenario with relatively lower resource potential (CRES). In the URES and NFS, the share of VRE will increase further to about 88% (65% solar PV and 23% wind) and 95% (76% solar PV and 19% wind) of the total generation, respectively. In 2050, hydro has the maximum share in the generation mix at ~4% in the CRES and a minimum at ~3% in the URES.

Figure 28 shows that a complete replacement of coal even by 2050 will be a tricky proposition. For instance, coal-based generation still contributes around 8% of the total generation in the URES, whereas coal has a significant generation share (~23%) in the CRES. However, if fossil-based generation capacity is replaced with the renewable-based generation, the grid emission factor will drastically reduce. In the URES, the grid emission intensity reduces to 0.07 (kgCO₂/kWh) by 2050 compared to the present level of 0.71 (kgCO₂/kWh).⁷⁰

Further, we consider timestamps with the ten highest loads for each year to analyze the contribution of each technology to the peak electricity demand between 2025 and 2050. Figure 29 shows the generation share to the peak demand on the primary axis and the solar PV and wind aggregate generation share on the secondary axis for the URES and the NFS. Coal-based generation continues to support peak demand till

⁷⁰ Further, the unserved load in the total electricity demand across all scenarios is negligible. In the CRES, the unserved load is around 0.13%, and in the URES, it is approximately 0.015% of the total electricity demand in 2050.

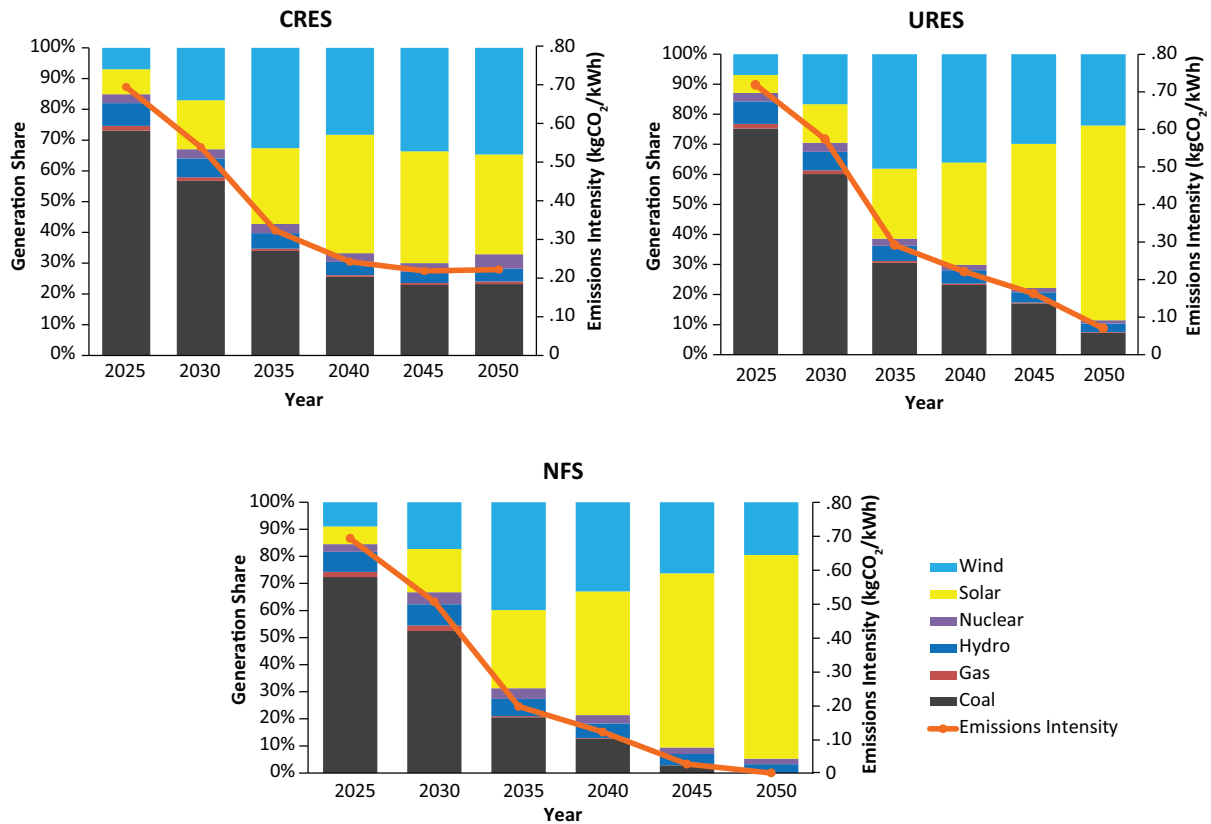

Figure 28: Generation share % of various sources and grid emission factor (kgCO₂/kWh) across scenarios

2030, contributing ~ 55–70% to the peak electricity demand in URES and the NFS. However, after 2030, the share of fossil-based generation is projected to reduce due to RE integration, and beyond 2040, BESS contributes ~10–40% and 30–55% to the peak electricity demand in the URES and NFS, respectively. It should be noted that the peak demand instances mainly occur during the evening hours; hence, BESS shows a significant contribution to the peak demand by shifting the daytime solar PV generation.

Figure 30 shows the generation in each of the listed scenarios elaborated by time slice in 2050 compared to the CRES generation in 2025.

The visualization of generation detailed by time slice and seasons is adapted from the National Renewable Energy Laboratory (NREL) study.⁷¹ Each technology choice that the model prefers drives the investments and has a unique role in the daily and seasonal balancing. There is a significant amount of coal generation during the evening and night hours of the day; however, in the NFS, this is replaced by the build-up of BESS to meet demand during periods of low VRE generation. Across all scenarios, gas-based generation helps meet the peak demand until 2025. By 2050, BESS could replace gas-based generation for daily balancing. Further, some RE curtailment during the daytime occurs

⁷¹ <https://www.nrel.gov/docs/fy17osti/68530.pdf>



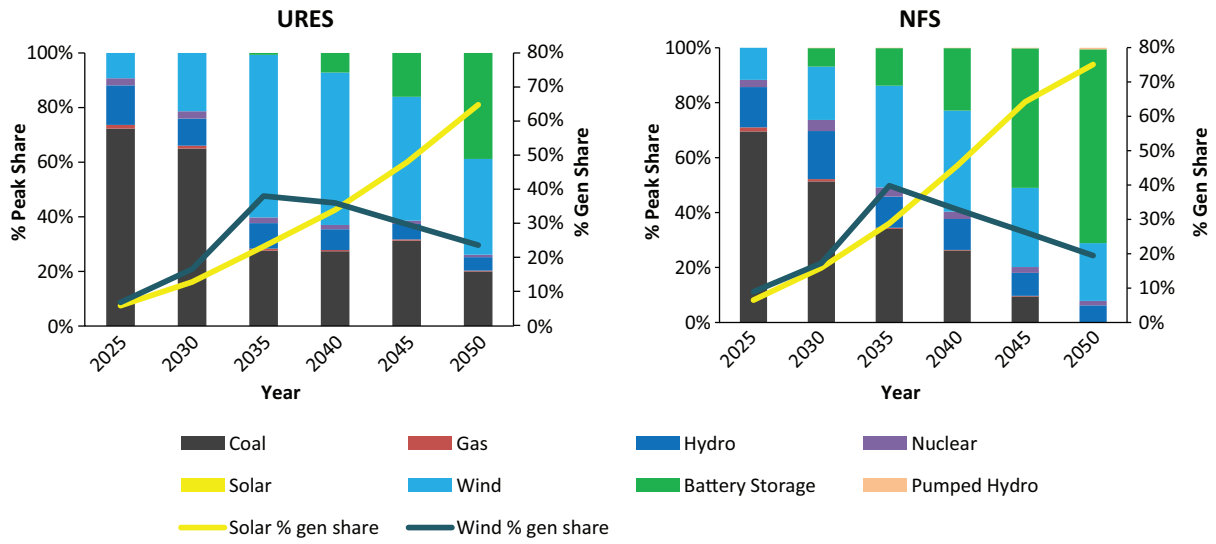

Figure 29: Technology contribution in peak demand and annual RE generation contribution in URES and NFS

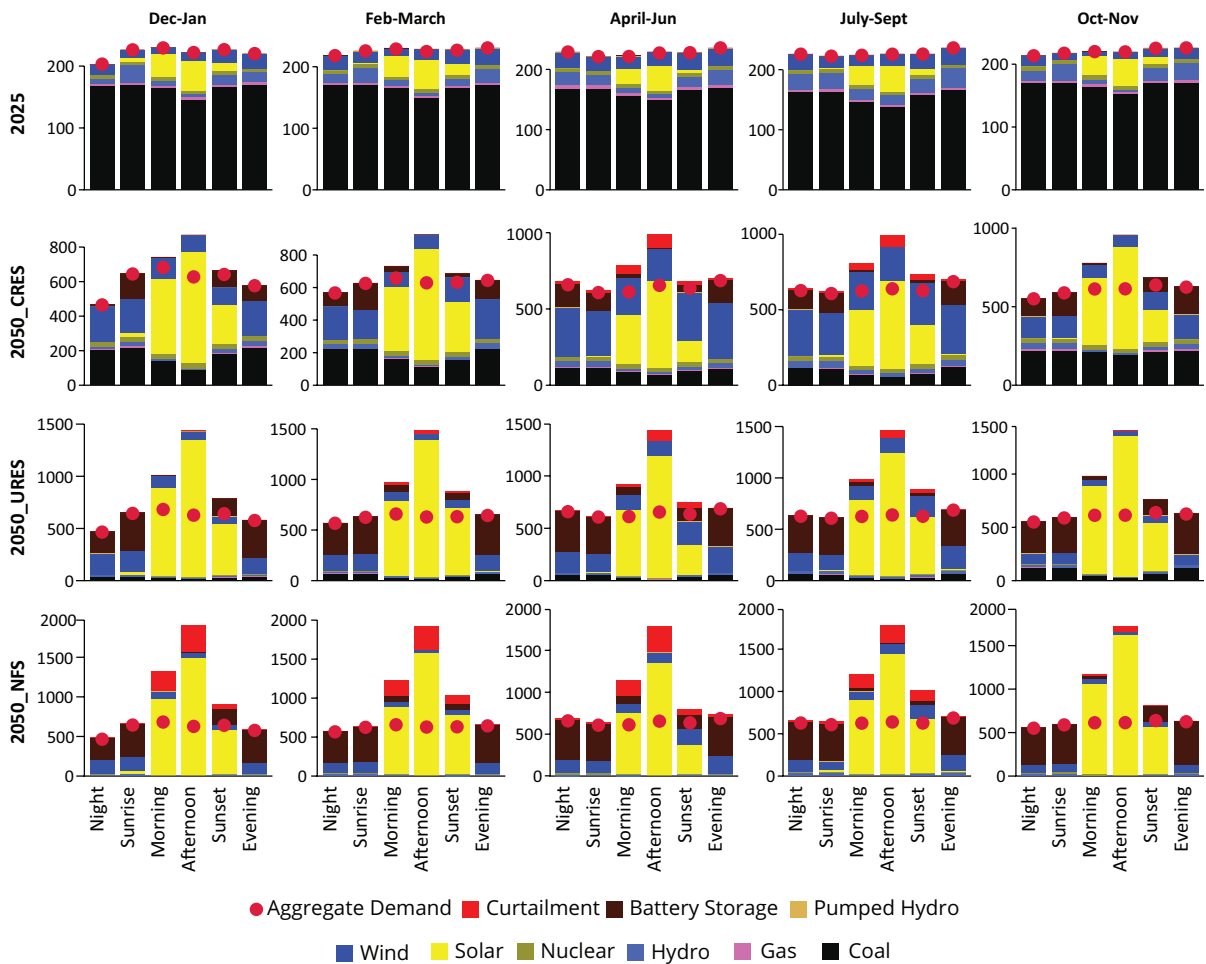

Figure 30: Generation by time slice in GWh

because overbuilding solar PV is cost-effective. In the NFS, we observe substantial curtailment due to the absence of suitable long-term storage technology. The buildup of solar PV is influenced by the months having the highest net-load (difference between load and solar PV generation), thereby potentially leading to excess generation in other months, due to the absence of any long-term storage technology. In the URES, coal based generation provides cost-effective seasonal balancing, thereby reducing the overbuilding of solar PV and reducing curtailment.

6.3 Dispatch Stacks

Figure 31 shows the generation and storage dispatch stacks for each scenario's peak demand day in 2050. In the CRES, on the peak demand day, the demand is met by wind (although the variability of wind could limit its contribution to the supply of demand during peak hours), and coal-based generation, with hydro and gas-based generation contributes to the peak demand. Owing to a lower cost, pithead coal plants run in a baseload operation in the CRES, whereas the non-pithead coal fleet operates during non-solar hours to supply the evening ramp requirement and generally has a two-shift operation. In the URES, pithead coal runs in a baseload operation during the day, whereas non-pithead coal adds to the generation mix to support the evening peak requirement, especially during months of low-wind generation. In the NFS, most of the peak load is met by BESS despatch.

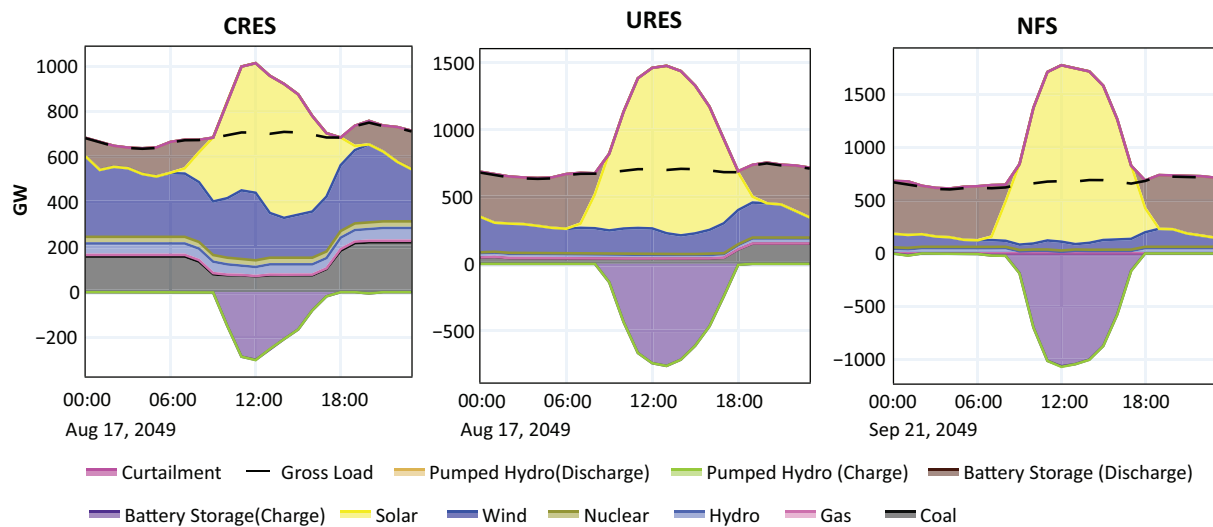

Figure 31: Peak demand day dispatch stack for CRES, URES, and NFS

VRE supplies most of the electricity demand by 2050 in URES and NFS. The contribution of solar PV and wind in the URES increases to around 88%, wherein solar PV itself supplies 65% of the total electricity demand by 2050. Most of the balancing/flexibility needs in URES and NFS are met by BESS. It caters to both the ramp requirement and the intra-day energy shift requirement. The BESS charge for around 7–8 hours is subject to the availability of solar PV generation and discharge during non-solar hours (12–14 hours) to meet the electricity demand during non-solar hours in a solar PV dominated electricity system.



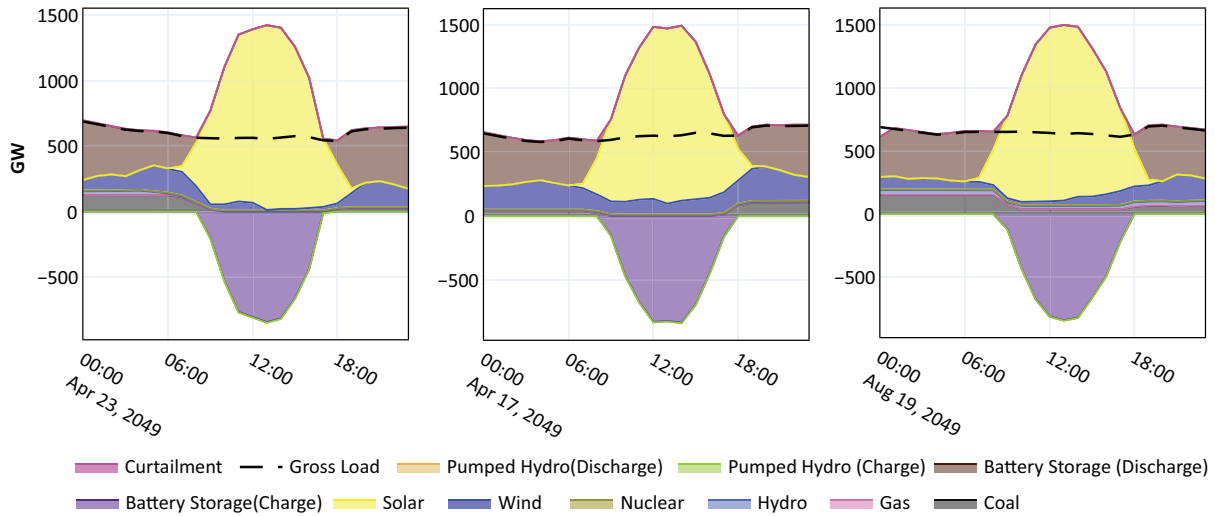

Figure 32: Despatch during (a) Low wind generation, (b) Minimum coal generation day, (c) Highest Coal Generation day in URES

We also analyse the despatch in the URES on critical days, including low wind generation, minimum coal generation, and a day with maximum coal despatch, as seen in Figure 32. A lower wind generation period occurs during midday in April, although with a relatively moderate wind in late evening. On the day with minimum coal generation, a higher VRE penetration is observed mostly from wind and relatively high solar PV generation. Maximum coal generation day coincides with the week with the peak demand day in August, where coal provides 32% of overall generation and 27% of the peak demand.

6.4 CUF and RE Curtailment

Table 17 compares the average fleet CUFs for different generation carriers in each scenario. As the model does not allow flexible operation for nuclear power plants in any of the scenarios, the utilization factor is constant throughout the investment period. The region-wise generation from the hydro run-of-river (RoR) fleet is constrained by the daily generation profile⁷² (seasonal) for respective regions.

Pithead coal plants run at a higher load factor than non-pithead coal plants and support baseload operation in CRES and URES, with the highest CUF in the CRES and URES in 2050. In the URES, high VRE penetration, particularly solar PV, forces pithead and non-pithead coal to back down its generation resulting in a lower CUF. Due to the reduced coal-based generation capacity in the NFS, the CUF of non-pithead coal-based generation increases to ~79% compared to 57% in the URES in 2030.

⁷² Daily generation profile developed considering historical unit-wise daily-generation data

Table 17: CUF of technologies in the study

Carrier	CRES			URES			NFS		
	2030	2040	2050	2030	2040	2050	2030	2040	2050
Coal pithead	88.5	77.5	72.8	88.5	73.6	65.3	87.5	64.2	0
Coal non-pithead	57.4	34.2	51.2	57.4	27.7	18	78.9	28.1	0
Gas CC (Domestic)	86	71.4	45.6	86	64.2	45.8	80.3	41.2	0
Gas CC (Imported)	0.5	1.4	12.5	0.5	2.2	0	29.7	2.1	0
Hydro	41.4	41.2	42.4	41.4	41.1	40.3	42	41.5	39
Nuclear	70	70	70	70	70	70	70	70	70
Solar	20.6	25.6	27	20.6	25.2	27.7	19.8	25.4	25.8
Wind	29.1	32.9	31.2	29.1	33.4	34.6	29	33.4	33.5

After 2035, solar PV and BESS (BESS cost at 80 \$/kWh) are likely to replace even pithead plant generation and limit coal generation to support the peak demand. Similarly, though domestic gas for power generation is limited, the model finds it viable to use domestic gas-based generation to support the system during peak hours, mainly in the evening. Due to relatively high gas prices, generation using imported gas is limited.

The significant addition of RE in the absence of fossil fuel capacity, particularly in the NFS, substantially increases curtailment, as seen in Table 18. Wind curtailment occurs especially during peak wind generation months. However, the curtailment observed in all the scenarios is not more than 7% of total RE generation. In the NFS, the curtailment is 11% (7% solar PV, 4% wind).

Table 18: Solar and wind curtailment

	CRES			URES			NFS		
	2030	2040	2050	2030	2040	2050	2030	2040	2050
Solar PV	0%	1%	1%	0%	3%	2%	0%	4%	7%
Wind	0%	1%	3%	0%	1%	1%	0%	1%	4%

Decreasing Utilization of Coal After 2025 – Assessment through Coal Generation Duration Curve and CUF

As mentioned earlier, the coal-based generation capacity in the CRES and URES still contributes to the overall generation mix. In such a case, it is essential to analyse the operation of such plants in 2050.

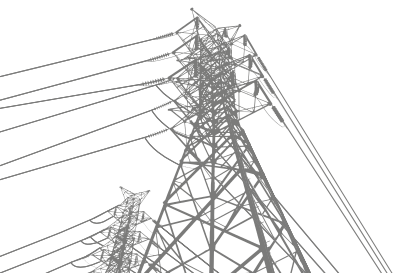

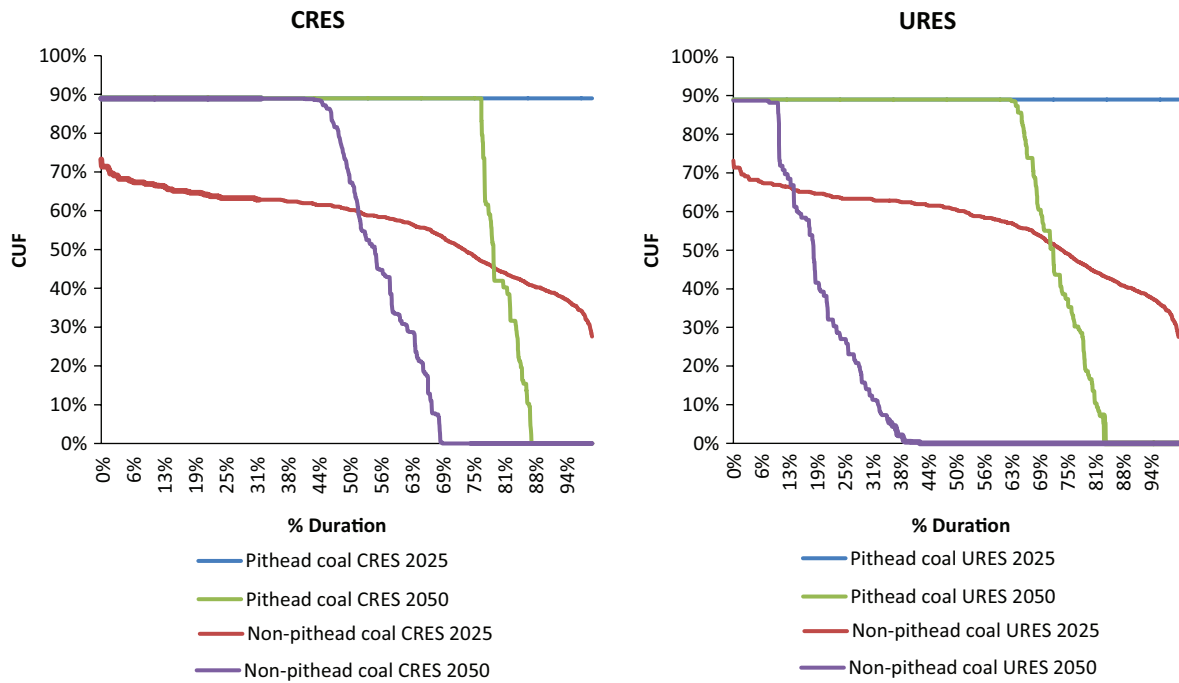

Figure 33: Coal despatch duration comparison in CRES and URES

Figure 33 shows the coal-generation duration curve for pithead and non-pithead coal-based generators, sorted in descending order, plotted against the percentage duration of the analysis period (yearly) in the CRES and URES. Pithead power stations have a significant role in 2025 and 2050, as their utilization factor only varies marginally, owing to the low variable cost of generation. However, the role of non-pithead plants, which support baseload requirements and ramping support until 2025, will drastically reduce due to their higher cost by 2050. This is also because the addition of RE and BESS will make most of their capacity dormant for a higher duration, which significantly reduces their plant load factor. In addition, these plants will be required to operate more flexibly. The role of non-pithead plants becomes limited to supply only during the peak load. Hence, it is anticipated that such plants need to be retrofitted to provide the required level of flexibility.

In the URES, by 2025, although most of the non-pithead coal power plants get year-round despatch, these plants would require a higher degree of ramp-up/ramp-down to integrate solar PV and wind. In contrast, pithead plants are used to meet the baseload due to a relatively lower variable cost.

Figure 34 shows that as the VRE penetration increases, the CUF of non-pithead power plants reduces, reaching 32% by 2040 in the CRES. Although the CUF of pithead power reduces only to around 75%, these power plants will be required to ramp down or shut down entirely during solar hours in the peak wind-generation months of the year. After 2035, non-pithead coal power plants would likely be used only for seasonal balancing. By 2050, the CUF of pithead coal reduces to ~ 63% in the URES and may not be utilized during peak wind-generation months. On the other hand, some non-pithead generators do not get despatched continuously, thereby reducing the CUF to ~18% in the URES. The limitation on RE potential in the CRES would increase the CUF of pithead and non-pithead units.

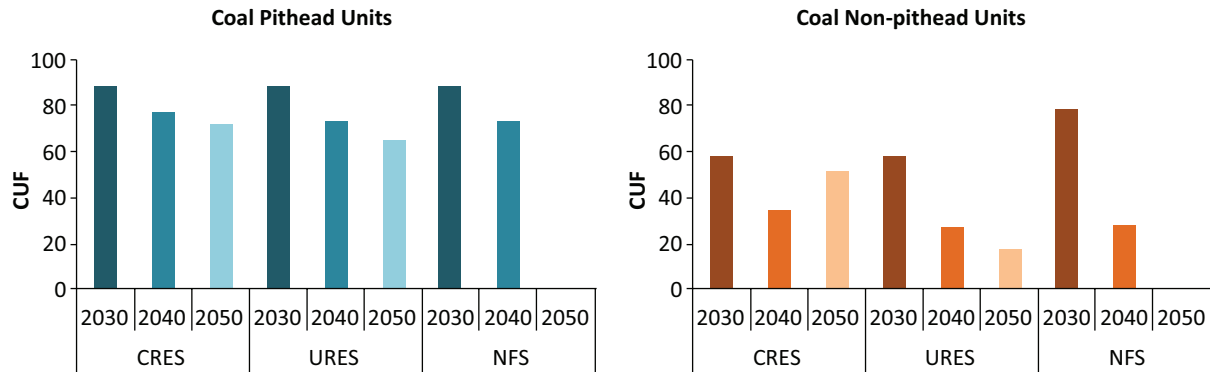

Figure 34: CUF (%) of coal pithead and non-pithead units

In the NFS, as the coal capacity reduces further after 2030, the net electricity demand during low wind and high load months has to be met by non-fossil fuel-based generation. This electricity and peak demand is supplied by forcing investment in solar PV, BESS, and nuclear capacity. This can be seen after 2035, where further investments in solar PV and BESS reduce the CUF of pithead coal-based power generators. Solar PV + BESS capacity built to meet demand during peak months reduces the CUF of pithead coal during other months of the year. The remaining coal capacity is only used for generation for a short period, during peak load and low wind-generation months.

Flexibility from the Coal-generation Fleet

Figures 35 show the percentage of non-pithead coal-based generating units running during the representative period (2016 timestamps) in each investment year in the URES. The integration of RE after 2030 will require a more flexible operation from the non-pithead coal-based generators. But, generator (thermal) retirement and the higher cost of storage by 2030 result in the increased utilization of non-pithead coal-based generators, especially during peak load months and months with low solar PV or wind-based generation. But the despatch from these plants reduces during months with relatively lower electricity demand and when the cumulative generation from solar PV and wind is comparatively higher. Due to the higher variable cost as compared to pithead coal-based generators, the despatch of non-pithead coal-based generators reduces significantly after 2030. Many of these generating units get despatched for only a short duration in a year, wherein they operate at their technical minimum during non-peak hours of a peak load day. After 2040, a few non-pithead generators do not get despatched for the entire year, whereas a significant portion of them are used only for seasonal balancing.

The lower variable cost pithead coal-based generators show a slightly different operating characteristic than the non-pithead generators. Figure 36 show the percentage of pithead coal-based generating units running during the representative period (2016 timestamps) in each investment year in the URES. The frequent start-up and shutdown of pithead coal-based generators are seen only after 2045, but many pithead-power plants may be required to operate at their technical minimum during the daytime after 2035. Further, the temporal distribution status of non-pithead units running in URES in 2050 is shown in Figure 37.

Note: The technology-wise operating parameters that define the flexibility of a thermal power plant include minimum thermal load, maximum ramp up/ ramp down rates, and minimum up-/down-time constraints.



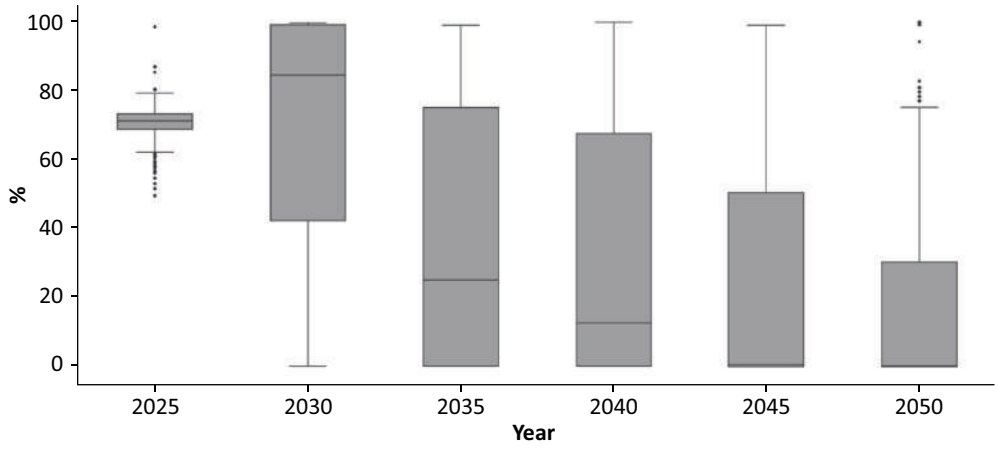

Figure 35: Percentage of units running amongst non-pithead coal power plants in URES

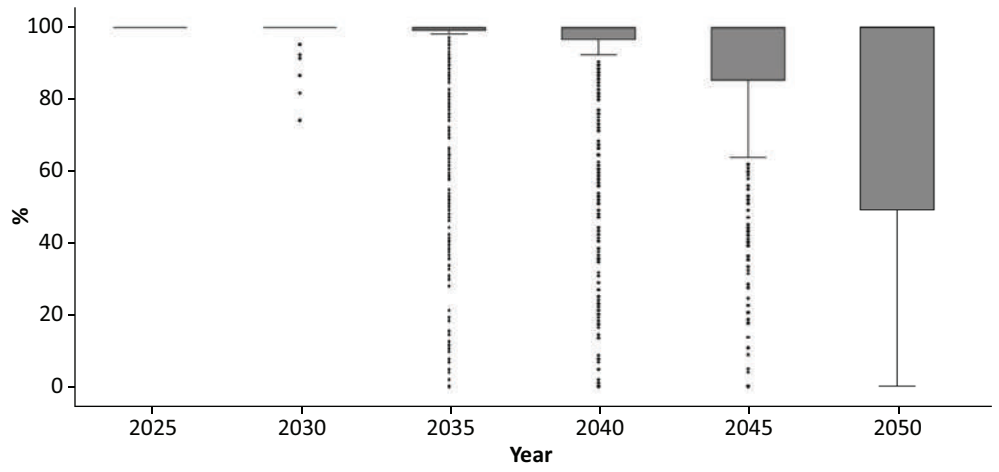

Figure 36: Percentage of units running amongst pithead coal power plants in URES

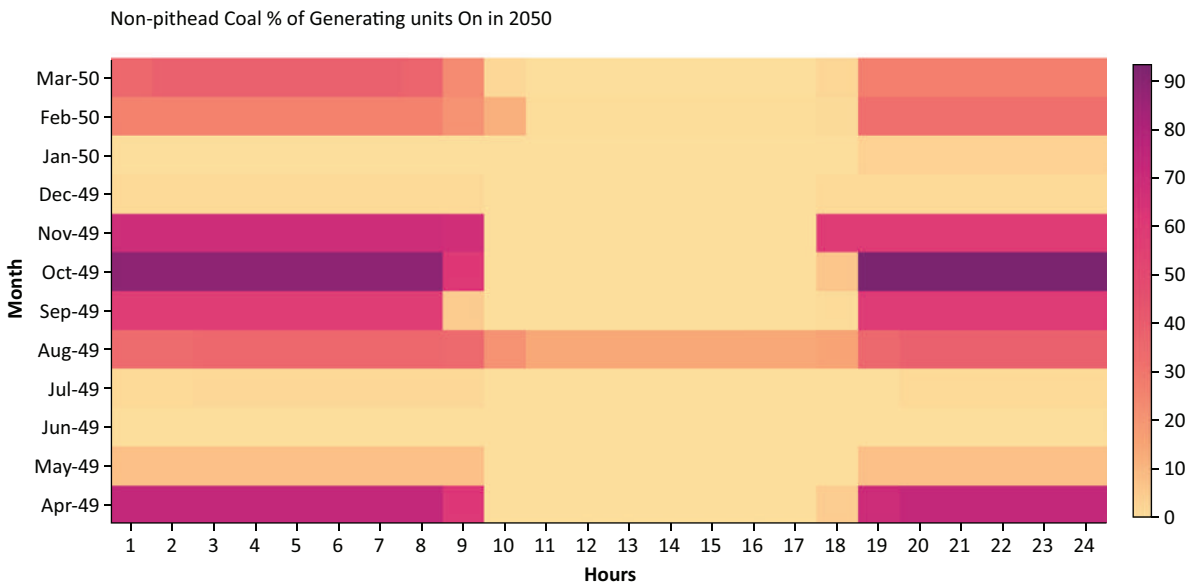

Figure 37: Temporal distribution status of non-pithead units running in URES in 2050

6.5 Investment Requirements

Table 19 indicates the capital investment required to build generation and storage capacity. It does not include the transmission and distribution upgradation cost. The power sector decarbonization in India will be supported by aggressive investments in zero/low carbon technologies. We estimate that by 2050, a total of USD 1.3–1.5 trillion needs to be invested in both zero carbon and other generation technologies. Solar, wind, and energy storage technologies constitute to a total of 75% and 90% of the total investments by 2050 in CRES and NFS, respectively. Overall system-level cost, including investment cost and operational cost, is lower in URES compared to per-unit system cost in CRES and NFS due to variable cost substitution, as explained in Section 6.6.

Table 19: Investment for capacity addition in various scenarios

Technology	Capital investment from 2025 till 2050 (in Billion USD)		
	CRES	URES	NFS
Solar	340	649	799
Wind	492	312	287
BESS	124	226	356
Others - Coal, Nuclear, Hydro	325	113	105
Total (Billion USD)	1281	1300	1547



6.6 System Cost

Figure 38 illustrates the system cost (Rs/MWh) for all the considered scenarios bifurcated into fixed cost and variable cost. The fixed cost includes the repayment of investment liabilities of existing new generators based on their useful lifetime and date of commissioning. The variable cost consists of fuel and generator start-up costs. The additional operational expenses on account of degradation in heat rate and part-load operation, transmission charges, and distribution cost are not considered in this study but could be significant with an increase in RE penetration.

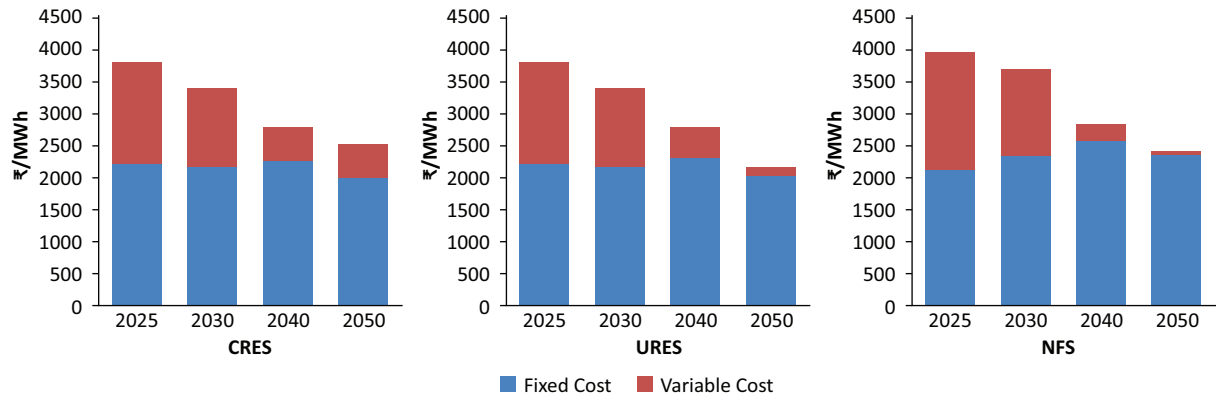

Figure 38: System cost (Rs/MWh) across scenarios

The overall results for system cost for different years suggest that the high RE integration can reduce system cost up to 30% - 40% by the year 2050. The integration of RE leads to the substitution of a higher variable cost with the fixed cost component of RE. A further reduction in RE and BESS costs reduces both the fixed and variable costs, thereby substantially reducing the total system cost.

The constraint on RE potential in the CRES results in a higher variable cost component of the system cost in 2050, increasing system cost as compared to the URES and NFS. In the URES, unconstrained RE integration resulted in an overall system cost reduction year on year, hence suggesting a further reduction in the variable cost components, resulting in an overall decrease in per-unit system cost. The results for the NFS indicate an increase in system cost by ~7% over URES due to the further addition of RE and battery storage as the utilization of BESS reduces and RE curtailment increases.

6.7 Reserve Requirement

The generation capacity reserves, namely planning reserves/reserve margin and operating reserves, are generally considered while carrying out power system planning studies. The reserve margin of a power system is defined as the difference between the installed capacity and the peak load met as a percentage of the peak load met. A reserve margin is not explicitly modelled in this study, but a constant fixed and planned outage of 10% for all thermal generators was assumed to satisfy the reserve margin requirement.

The total operating reserve requirement is assumed to be 5% of the electricity demand and 5% of the total wind-generation forecast for each region in each timestamp. Various technologies such as hydro, pumped hydro, BESS, gas, and coal are considered for supplying operating reserves. The ramping capability for each technology limits the contribution of different technologies to the operating reserve. The technology-wise cost of providing operating reserve and the percentage of maximum capacity contribution to the operating reserve, as mentioned in Section 2.2, influences the level of participation of generators, pumped hydro storage units, and BESS in providing the operating reserve requirements of the system. The cost of providing operating reserves considers the incremental cost incurred by an asset in increasing its scheduled dispatch by 1 MW.

Figure 39 shows the maximum reserve requirement as a percentage of total electricity demand from 2025 to 2050 for the URES and CRES. The increase in load and wind penetration from an existing capacity of 38 GW to 693 GW in CRES results in a corresponding increase in the spinning reserve requirement. Thus, due to the highest wind generation build-up, CRES would require the most operating reserve capacity of ~60 GW. By 2030, in all the scenarios, BESS supplies more than 60% of the total operating reserve requirement; the rest is met by hydro, gas, and coal-based generator capacity, and by 2050, BESS is expected to supply ~95% of the total operating reserve requirement.

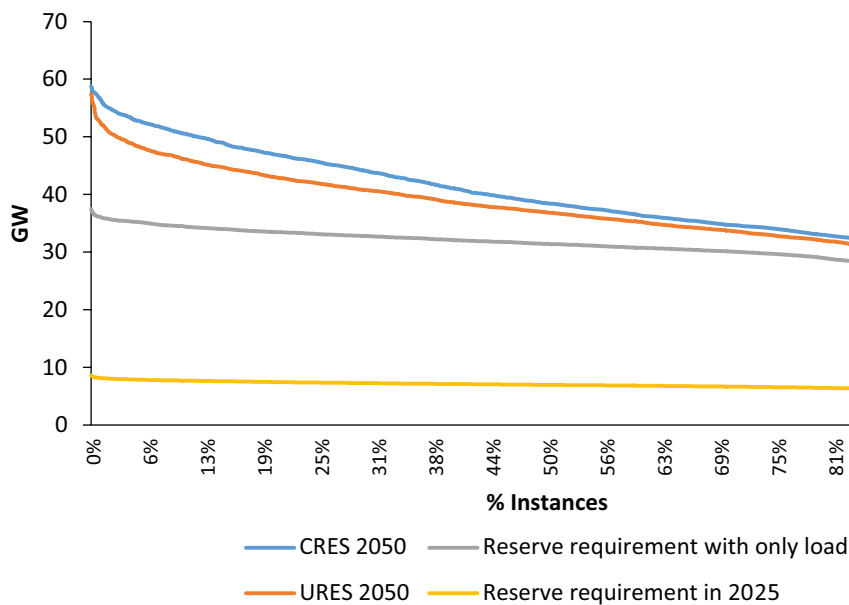

Figure 39: Reserve requirement at each time instance

Further study is required to better understand the technical limitations of different technologies in supplying operating reserves as well as the associated incremental cost assumed in providing the same. Moreover, the study does not assume any operating reserve margin for solar PV generation. A deviation from this assumption could influence the results.



6.8 Transmission Build-up and Inter-regional Power Flow

Herein, we discuss the inter-regional transmission capacity addition and power flow across the scenarios by 2050. Figure 40 shows the inter-regional transmission capacities across the years as compared to the current level, while Figure 41 shows the power flow across the regions in all the scenarios. By 2025, the early retirement of coal plants in the Western Region (WR) makes it a net importer of electricity in the NFS compared to CRES and URES. Until 2030, a relatively lower demand, compared to other regions, coupled with a high coal-based generation capacity in the Eastern Region (ER), results in considerable power flow from ER to Northern Region (NR). Due to high demand, NR imports heavily from the electricity surplus ER. In the NFS, the early retirement of coal plants in the WR further increases power flow from the ER to the WR. The existing inter-regional transmission capacity between the two regions—including power flow capacity through WR—is sufficient, requiring no capacity addition.

Further, the addition of wind-power generation capacity to 2035 in the WR will significantly increase the power flow between WR and NR. A relatively higher buildup of wind in the WR in the URES and NFS will increase transmission capacity requirement between the NR and WR, which is not required in the CRES, wherein there is still a relatively high power flow from the ER. The reduction in BESS cost by 2035 is expected to increase solar PV capacity in the NR, WR, and SR. However, a higher increase in demand in the NR will also require a power import from the WR. Coal-based generation capacity in the NR, WR, and ER provides balance power during the low wind-generation month. The power flow after 2040 is very different in the CRES compared to the URES and NFS. In the latter, solar PV generation capacity increases in the NR, thereby increasing the power flow from the NR to other regions, including the WR (during instances of low wind generation). In the CRES, a considerable buildup of wind capacity in SR results in a significant power flow from the SR to other regions during months of high wind generation, while still importing power from the NR and WR during other months of the year.

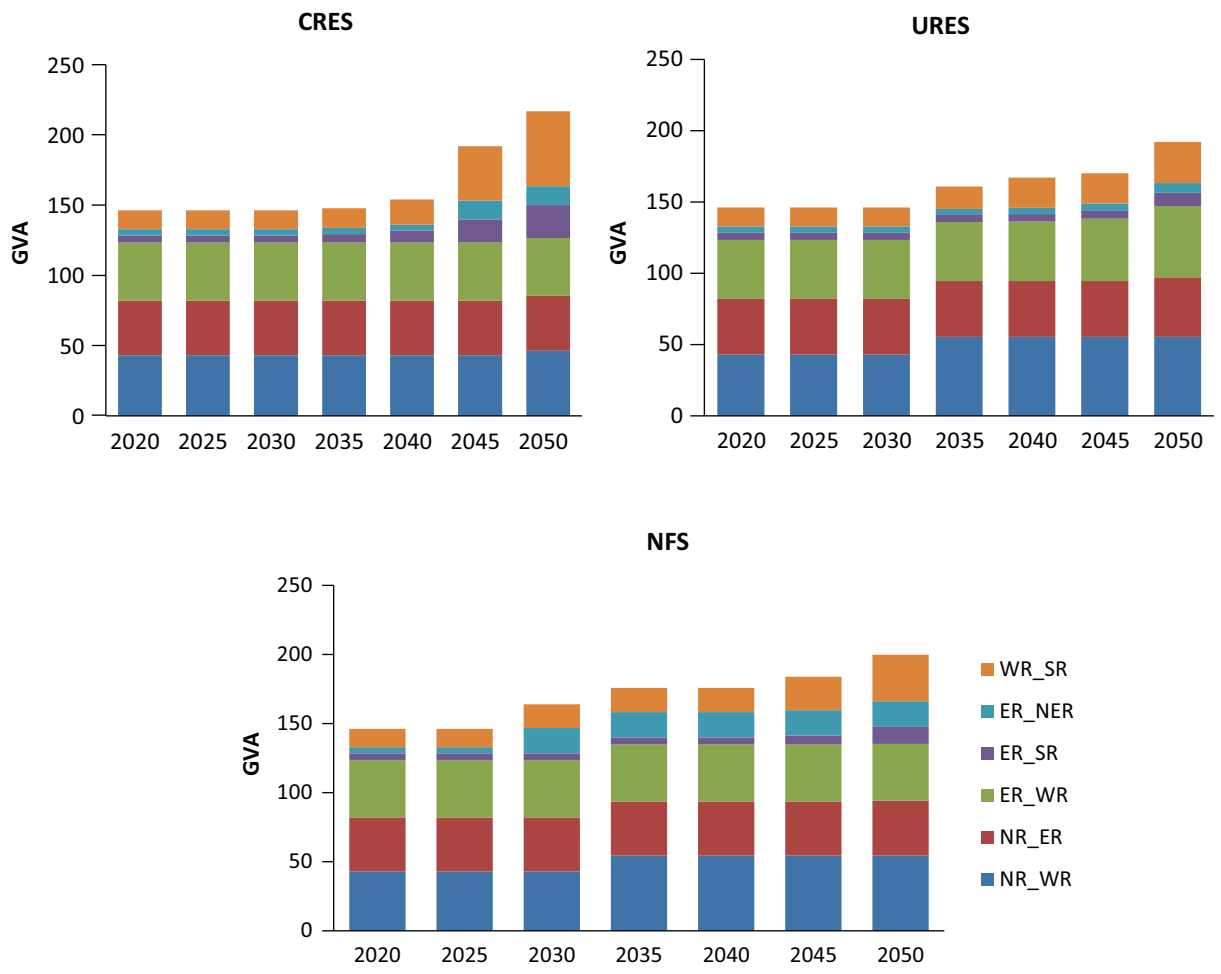

Figure 40: Inter-regional transmission capacity requirement in 2050 with respect to the current capacity



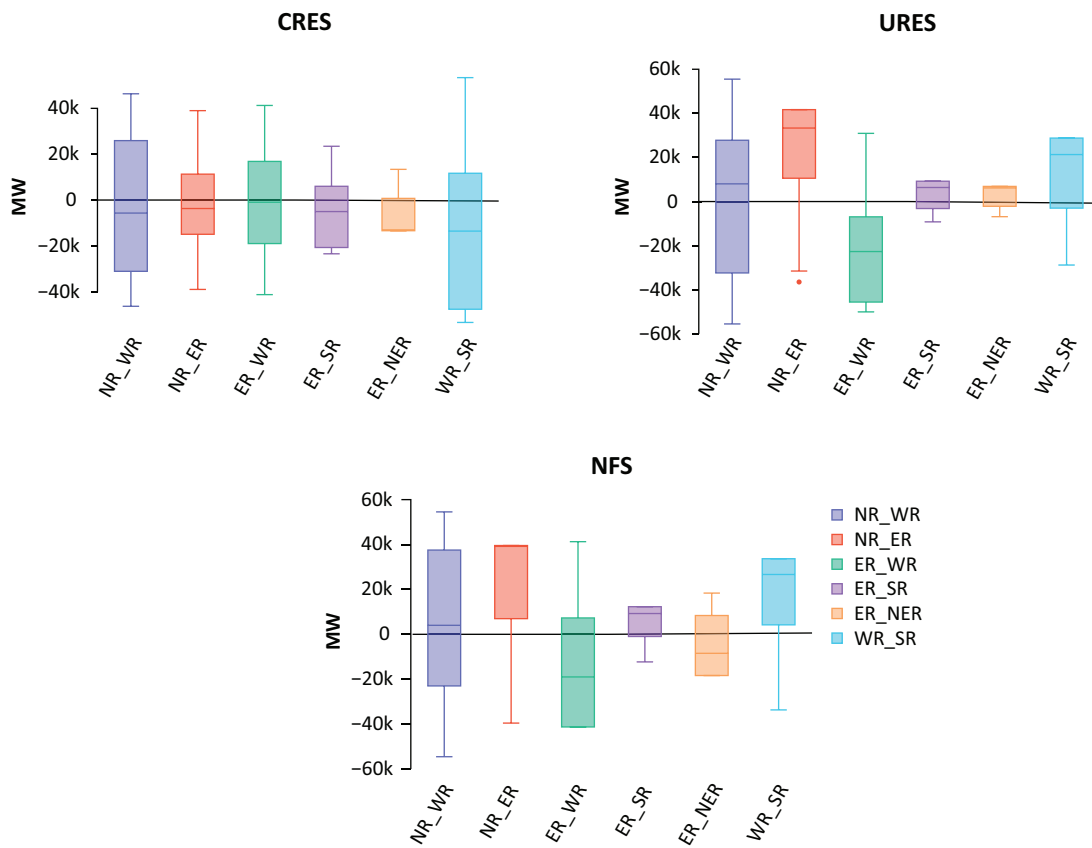

Figure 41: Power flow between regions in 2050

7. Insights from the Scenario Sensitivities



As the Indian power system transitions with high RE integration up to 2050, uncertainties about cost trajectories/investments in various technologies persist. Hence, we try to address these uncertainties by coming up with alternative scenarios that may change the investment decisions due to prevailing uncertainties over technology choices, changes in demand patterns, etc. We consider a scenario with a lower operating reserve requirement owing to only load forecast uncertainty, a scenario with comparatively low annual electricity demand, and a scenario with high BESS cost (\$80/kWh in BESS_80 scenario and \$100/kWh in BESS_100 scenario). As we may recall from Section 5.1, the sensitivity scenarios are modified considering the URES as the baseline. Some key scenario results are presented in Table 20. In the further sub-sections, we discuss each of the sensitivity scenarios and their underlying impact in comparison to the URES.

Table 20: Comparison of installed capacity (GW) across the scenario sensitivities and URES

Technologies	Installed Capacity in 2050			
	URES	Low demand	BESS_80	BESS_100
Coal	169	164	211	211
Gas	2	5	3	7
Hydro	44	45	47	50
Nuclear	10	14	14	23
Solar	1472	1343	1250	1101
Wind	421	429	491	592
Total Installed Capacity*	2118	2000	2016	1983
BESS capacity	864	773	689	562

*Excluding PSP

Sensitivity on Low Reserve Requirements

In this scenario, we assume that by 2050, the reserve requirement to meet the uncertainty due to wind forecast error is not required as the presence of accurate forecasting could be expected to reduce its need. Hence, the operational reserve requirement is limited to meet the uncertainty due to the load forecast itself.

Sensitivity on Low Demand Scenario

The electricity demand is reduced by 6% in this scenario sensitivity, resulting in a corresponding ~6% reduction in peak power demand as compared to the URES. The peak power demand occurs during the night or non-solar hours; hence, this demand could either be met by coal power plants or BESS. The results of this sensitivity case indicate an increase in CUF of non-pithead units, which suggests that to meet the electricity demand by 2030, it is cost-effective to increase the generation from non-pithead coal power plants rather than build additional pithead coal capacity. With the decrease in the peak requirement, the battery capacity, and accordingly solar PV capacity, reduces in 2050 in comparison to their respective capacities in URES.

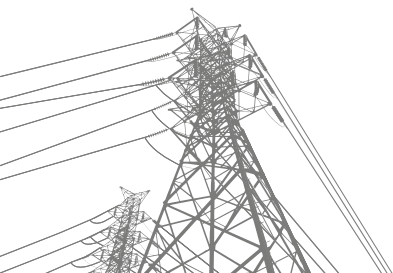

Sensitivity on High Battery Pack Cost

Figure 42 shows the assumed capital cost related to battery pack for this sensitivity. The difference in the BESS cost varies from 2025 to 2050. The battery pack cost in the BESS_100 sensitivity is ~1.4 times as compared to the URES. The capital cost of BESS changed from \$60/kWh to \$80/kWh in the BESS_80 scenario and \$100/kWh in the BESS_100 scenario by 2050.

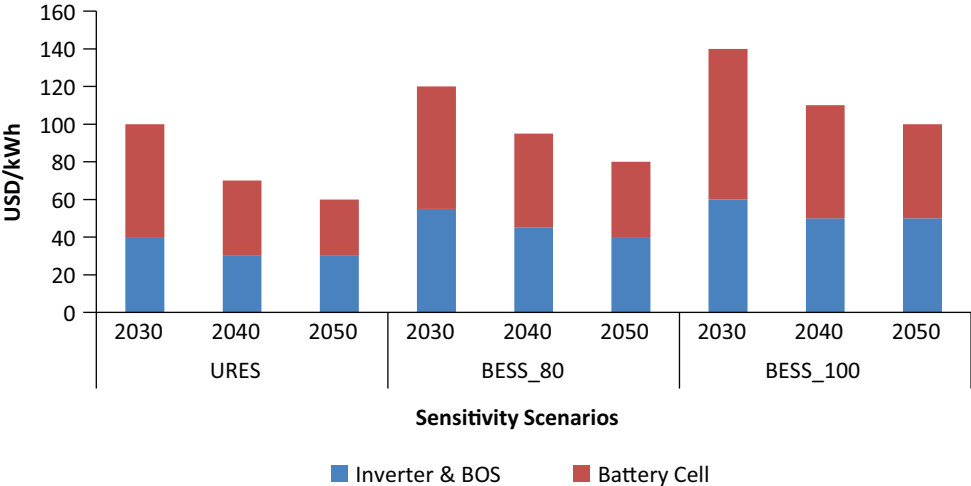

Figure 42: Battery pack cost assumptions across the scenarios

The BESS cost assumptions influence investment decisions in various generation and storage technologies. Figure 43 shows the capacity build-up of solar PV, wind, and BESS for the URES and battery cost sensitivity scenarios in the year 2050. We observed that the build-up of solar PV and BESS reduces with an increase in battery cost and results in higher wind and other technology build-ups. Also, due to the relatively lower build-up of BESS system in higher cost sensitivities, the curtailment of solar-PV and wind power increased marginally by 2%.

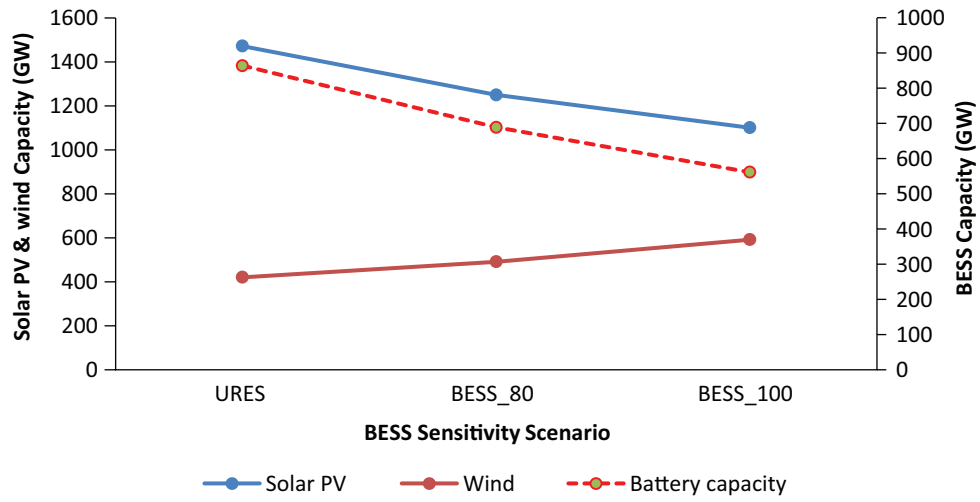

Figure 43: Installed capacity for Solar PV, wind, and BESS in the year 2050 for URES and BESS sensitivity scenario

From the results, it can be inferred that the cost of BESS has a significant impact on the overall decarbonization of the power sector. In the absence of adequate energy storage technologies, other fossil-based technologies have to support the grid operation to balance electricity demand.



8. Areas of Further Research and Model Improvement



This study has not considered some of the components that could play an important role in India's energy transition in the coming years. These limitations provide potential avenues for further exploration and research. Some of them are discussed below:

- » **Potential of demand response interventions to reduce peak demand:** As the integration of VRE increases, the load during the peak hours could be shifted in order to coincide with the solar PV generation. The level of flexibility of the load depends on the load type, sector, etc. Quantifying the level of flexibility and incentives to users is critical in modelling and understanding the role of demand response in energy transition in India.
- » **Production of hydrogen from renewable energy:** With an increase in the VRE penetration, green hydrogen could play an important role in the deep decarbonization of some hard-to-abate sectors. This could provide flexibility to the VRE-rich power system, and green hydrogen may be explored as another energy storage solution. Hence, modelling the use of hydrogen and its impact would help understand its role in the deep decarbonization of the energy sectors.
- » **Projection of future electricity demand curves:** Another key area of further work is the projection of demand curves based on historical end-user demand patterns and assumptions around usage and stock. This, however, requires build-up from the state level to the national level, and the non-availability of end-use consumption pattern data at the state level is the constraining factor.
- » **Role and potential from other RE technologies:** Other RE technologies such as off-shore wind, floating solar, concentrated solar PV with thermal storage, geothermal energy, open-cycle gas power plant, compressed air energy storage, power to hydrogen and hydrogen to power conversion, etc., could also be added as potential candidates to electricity supply and balancing studies.
- » **Alternate modelling methodology:** The myopic optimization model used in this study returns the optimal dispatch or power flow and the least cost capacity addition of different power system components. But there may be multiple solutions in terms of the level of RE penetration, emission intensity, etc. Some of these solutions/scenarios (near-optimal alternatives) may only cost marginally more than the optimal solution and have a higher social benefit, improved reliability, and grid resilience. The modelling to Generate Alternatives (MGA) methodology can be used on models that have a foresight into the future and help in identifying and examining the near-optimal alternatives.
- » **Technology cost:** It has a significant impact on the build-up of various generating capacities to meet future demand requirements. In this study, the capital cost and fuel cost are assumed to be the same across different scenarios. A detailed sensitivity analysis, by changing various cost components, may be an area of further study.
- » **Grid security:** With a manifold increase in RE generation capacity coupled with BESS and decline in the quantum of synchronous machines in operation and the consequent reduction in power system inertia, security and stability of the grid will assume critical dimensions. Power system stability studies would need to be conducted with the generation mix from conventional and VRE sources as well as BESS.



- » **Cross-Border Electricity Trade:** The study is carried out for meeting the entire demand from the generating sources in India. At present, India's CBET is limited to its neighbouring countries - Nepal, Bangladesh, Bhutan and Myanmar. The transmission interconnection between India and Sri Lanka is under study/discussion. CBET is expected to gain traction in the coming years. The One Sun, One World, One Grid (OSOWOG) initiative, with the regional interconnections involving South Asia, South East Asia, Middle East and Africa and an eventual target of a worldwide interconnected grid, is expected to reduce the generation reserve, flexibility requirements and storage requirement in India. The study needs to factor in these developments in the coming years.
- » **Pumped hydro projects:** These are another area of growing interest as they act as an energy storage battery or water battery and also provide inertia and reactive power support. India has a potential of ~103 GW for pumped storage; Maharashtra has the highest potential followed by Telangana, Andhra Pradesh, Tamil Nadu, and West Bengal. The impact of this potential being wholly utilized on the Indian power system is another area to be studied in depth.
- » **Transmission system modelling:** The current modelling framework considers the copper-plate power transmission within the region. Intra-regional and Intra-state network modelling is another area for incorporation.

9. Conclusions

This report presents two electricity demand and three capacity scenarios till 2050. The intention is to explore various aspects of the transitions underway in the Indian power sector. The capacity scenarios were based on co-optimization of investment as well as operational costs. The capacity scenarios were explored in terms of different aspects: capacity, generation, PLF, system costs, emission factor, and investment requirements. Apart from these three scenarios, two sensitivity results are presented (Table 20 in Section 7) by changing assumptions on demand and reserve requirements. The main conclusions are as follows:

- » **India's grid electricity demand (ex-bus) is likely to grow fourfold and is expected to be driven by continued economic growth, strong industrialization, urbanization, rising per capita income, and the emergence of new demand drivers such as transport.**

The study suggests that the grid electricity generation requirement is likely to grow fourfold, reaching 5246 TWh and 4985 TWh by 2050 in baseline and low carbon scenarios, respectively. The per capita electricity consumption in the baseline demand scenario is projected to increase from 1181 kWh in 2018 to at least 1556 kWh by 2030 and 3004 kWh by 2050, further depending on the projected scenarios.

This assessed demand or generation requirement varies based on the actual growth of the economy in the long-term, captive consumption level, transmission and distribution system efficiency improvement, growth in charging requirement due to higher penetration of electric vehicle fleet, and green hydrogen generation requirement for the electricity to be sourced from the grid. We also estimate that peak demand requirement would increase to the order of 700–750 GW by 2050. It is to be noted that the capacities are projected under the assumption of the same shape of hourly load profile as in 2018. However, the demand profile has been witnessing a change and more structural change based on the evolving consumption behaviour from new demand centres such as transport, change in time-of-day tariff, promotion of decentralized renewable-based generation, etc., could be expected. Hence, the evolution of load consumption patterns has to be reviewed periodically to plan the flexible-generation requirement for the future.

- » **Higher degree of RE integration from today's level would be the least cost pathway.**

High RE integration in the Indian power system is essential from a climate perspective. Still, it is also a least-cost supply option to cater to the future electricity demand. The detailed results presented in Section 5 suggest that integration of VRE of the order of ~25 times of current installed capacity would be required to meet the electricity demand under baseline and low carbon scenarios. This VRE integration would be largely driven by the integration of solar photovoltaic technology complemented by BESS. The addition of solar PV and BESS capacity would be the least-cost option over many other capital-intensive technologies such as nuclear and non-pithead coal power generation capacity. Integrating such a volume of RE technology, including BESS, would require ~USD 1.2–1.6 trillion investments by 2050 (excluding distribution and transmission investments). Also, from a system cost (generation cost) perspective, RE integration is likely to result in a 35%–40% reduction in per-unit cost from the current level. However, high RE integration would require land area of the order of 8-10 million acres as well as significant financing.

» **Assessment of RE resource potential.**

The CRES results suggest that the solar PV and wind potential may get fully utilized by 2050 and additional conventional generation will be needed to meet the residual demand; thus, the model picks up the available least-cost options - nuclear and hydro capacities. Once we relax the RE potential constraint, as in URES and NFS, results suggest that India may require solar PV integration of twice the capacity of currently assessed potential by the year 2050. The sheer volume of RE integration suggests that the constraint of the current RE resource potential and various other options such as off-shore wind, floating solar PV, and rooftop solar PV are required to be analysed in-depth for integrating more RE in the Indian power system.

» **Role of coal fleet and reducing the dependency slowly.**

Coal power has dominated the power generation and has played a pivotal role in providing electricity, supporting the Indian economy and livelihoods of workers employed in the power sector as well as coal mining. The NFS is formulated in line with the target of many countries having pledged to go carbon neutral by mid-century. The coal fleet currently supplies the base-load, but this is expected to change in the future. The declining capacity factors of coal power plants, particularly of non-pithead stations in the scenarios analyzed suggest that energy storage systems would partially replace the peak load support from such power plants. Such plants would require a very high degree of operational flexibility.

In the NFS, early phasing out of coal-based capacity may lead to higher capital investment and a comparatively higher system-level cost. In URES, the balance coal capacity in 2050 has an average age of 10 years, which suggests the feasibility of retirement of the majority of the coal fleet by the year 2060. Therefore, as compared to NFS, URES is cost-effective in terms of investment as well as system costs and allows slow disinvestment in the coal sector.

» **Long duty hour battery energy storage system.**

BESS is expected to play a pivotal role in the integration of RE, particularly solar PV, beyond a certain level. Recalling from Figure 25 in Section 6.1, there is an increase in power and energy capacity in various scenarios across the investment period. The BESS capacity witnesses a maximum of 864 GW (5185 GWh) in URES and a minimum of 379 GW (2277 GWh) in CRES wherein the build-up of VRE is limited. Aggressive cost decline of BESS encourages the role of long duration energy storage in the power system from peak load supporter (initially) to a long baseload support operation.





We are an independent, multi-dimensional organization, with capabilities in research, policy, consultancy and implementation. We are innovators and agents of change in the energy, environment, climate change and sustainability space, having pioneered conversations and action in these areas for over four decades. We believe that resource efficiency and waste management are the keys to smart, sustainable and inclusive development. Our work across sectors is focused on (a) promoting efficient use of resources; (b) increasing access and uptake of sustainable inputs and practices; and (c) reducing the impact on environment and climate. Headquartered in New Delhi, we have regional centers and campuses in Gurugram, Bengaluru, Guwahati, Mumbai, Panaji, and Nainital. Our 1,000-plus team of scientists, sociologists, economists and engineers delivers insightful, high quality action-oriented research and transformative solutions supported by state- of-the-art infrastructure.

