



Distribution Utilities Forum

ELECTRIC VEHICLES: PERSPECTIVE OF DISCOMS AND STAKEHOLDERS

Alekhya Datta | Ashish Kumar Sharma | Ashish Rawat | Jyoti Sharma
Mukesh Kumar | Neshwin Rodrigues | Ram Krishan | Shashank Vyas



ELECTRIC VEHICLES: PERSPECTIVE OF DISCOMS AND STAKEHOLDERS

A study to highlight the actual and anticipated issues associated with EV charging for DISCOMs and other involved stakeholders from a technical, financial, regulatory and operational standpoint

Prepared for
Distribution Utilities Forum



Certificate of originality

Original work of TERI done under the project "A Stakeholder Forum for Key Actors in Electricity Distribution Sector"

Suggested format for citation

TERI. 2020
Electric Vehicles: Perspective of DISCOMs and Stakeholders
New Delhi: The Energy and Resources Institute; 83 pp.
[Project Report No. 2017EF33]

Disclaimer

This document is an output of a research exercise undertaken by TERI supported by the Shakti Sustainable Energy Foundation (SSEF) for the benefit of power distribution sector. While every effort has been made to avoid any mistakes or omissions, TERI and SSEF would not be in any way liable to any persons/ organizations by reason of any mistake/omission in the publication.

Published by

TERI Press
The Energy and Resources Institute
Darbari Seth Block
IHC Complex, Lodhi Road
New Delhi-110 003
India

For more information

Project Monitoring Cell

TERI
Darbari Seth Block
IHC Complex, Lodhi Road
New Delhi – 110 003
India

Tel. 2468 2100 or 2468 2111
E-mail pmc@teri.res.in
Fax 2468 2144 or 2468 2145
Web www.teriin.org
India +91 • Delhi (0)11

MESSAGE FROM

GIREESH B PRADHAN, HONORARY CHAIRMAN, DISTRIBUTION UTILITIES FORUM



At the tail end of the retail supply chain, DISCOMs have a crucial role to play in not only delivering last-mile connectivity to the end-consumers but also in meeting the government's vision of providing a robust infrastructure to support the integration of distributed energy resources. This role becomes all the more crucial if such resources are in the form of a fleet of mobile distributed energy storage units. Electric Vehicles (EVs) are being introduced in the power system with a more focused phase-wise approach and DISCOMs thus have a critical role to play in this development.

Electric mobility in the country is being spearheaded by the National Electric Mobility Mission Plan 2020 which is being administered through central schemes like FAME India that provide incentives and support manufacturing and R&D. The Ministry of Power has a major role to play in shaping up the charging standards, guidelines and best-practices for the EV ecosystem and thus emerges the role of DISCOMs in setting up, operating and maintaining charging infrastructure. Apart from DISCOMs, there are many other key stakeholders that will have their tasks cut-out in supporting the DISCOMs in a successful rollout and smooth operation of electric mobility in the country. However, there is a set of issues regarding EV charging infrastructure and a few concerns that are anticipated to impact all stakeholders.

The sixth meeting of the Distribution Utilities Forum (DUF), on the theme of EV charging infrastructure, was held on 18th February 2020, hosted by Bangalore Electricity Supply Company Limited (BESCOM). It saw participation from various DISCOMs and other key stakeholders involved in the implementation of electric mobility charging infrastructure. It is indeed heartening to note that the meeting witnessed healthy discussions among the stakeholders, with DISCOMs getting to express their issues and also listen to those of the other stakeholders. The ground realities, challenges and issues in the implementation of EV charging infrastructure were discussed at length and the participants came forward with suggestions that can enable the stakeholders to address the present issues.

Discussions at the meeting along with responses from preliminary discussions with DISCOMs and other stakeholders on the subject, results from a simulation study and proposed suggestions have been captured in this report.

I believe that you will find the report to be an insightful and an interesting read on this emerging topic.

A handwritten signature in black ink that reads "Gireesh Pradhan". The signature is written in a cursive style and is positioned above a thin horizontal line.

Gireesh B Pradhan

MESSAGE FROM

DR. AJAY MATHUR,
DIRECTOR GENERAL, TERI



In its commitment to combat climate change and meet its INDC goals, India has acknowledged the problem of rising air-pollution in its cities and has shown greater resolve to tackle the same as an immediate step to arrest the greenhouse gas emissions from the transportation sector. Electric mobility is one of the pathways that the country has pro-actively taken to mitigate the said problems. The National Electric Mobility Mission Plan 2020 aims at introducing a significant number of electric vehicles in the country and central schemes like FAME India have provided a shot in the arm for implementing the mission. However, a comprehensive network of well-managed public charging infrastructure and access to private charging is a must for a successful rollout of nation-wide electric mobility.

The sixth Distribution Utilities Forum (DUF) meeting, on the timely theme of electric vehicles, was held on 18th February 2020, hosted by Bangalore Electricity Supply Company Limited (BESCOM). It saw participation from various DISCOMs and other key stakeholders like oil marketing companies, OEMs, cab aggregators and government agencies that have a central role to play in the implementation and operation of EV charging infrastructure. I am happy to note that the meeting witnessed healthy discussions with the stakeholders airing their challenges/issues in implementation of electric vehicle charging infrastructure and coming forward with suggestions that can enable them to address the present issues.

Discussions at the meeting along with responses from preliminary discussions with DISCOMs and other stakeholders on the subject, and proposed suggestions have been captured in this report.

I trust that you will find the report to be an interesting read.

A handwritten signature in black ink, appearing to read 'Ajay Mathur'. The signature is fluid and cursive, with a horizontal line underneath the name.

Dr. Ajay Mathur,

MESSAGE FROM

VATSALA JOSEPH,

INTERIM CEO, SHAKTI SUSTAINABLE ENERGY FOUNDATION



Indian power distribution utilities face multifarious challenges not just in their day to day operations but are also grappling with large scale systemic changes that will eventually impact the utilities' overall business models. The transition to electric vehicles or zero emission vehicles is one such systemic change that they must adapt to rapidly.

To facilitate a smooth and sustainable transition to an electric mobility ecosystem in India, the power utilities must be on board, specifically in deploying electric vehicle charging infrastructure within their license areas. Given the speedy progress in the sector it is crucial to gauge the outlook of the Discoms towards e-mobility and understand and address their concerns. Therefore, the Distribution Utilities Forum decided to take up the subject for its sixth meeting, hosted by Bangalore Electricity Supply Company Ltd (BESCOM) in February 2020.

The meeting was attended by a record number of Discoms as well as government and industry stakeholders. Their presence threw up an all-round perspective that is captured in this report and the recommendations will be shared with all concerned stakeholders.

I believe you will find this report of interest.

A handwritten signature in blue ink that reads "Vatsala" with a horizontal line underneath.

Vatsala Joseph

CONTENTS

ACKNOWLEDGEMENT	xvi
EXECUTIVE SUMMARY	xvii
1.0 GLOBAL AND INDIAN ELECTRIC MOBILITY SCENARIO	1
1.1 Electric Mobility & Charging Infrastructure: Global Outlook.....	1
1.1.1 China.....	2
1.1.2 Norway.....	2
1.1.3 United States of America.....	3
1.1.4 United Kingdom.....	4
1.1.5 Japan	4
1.2 Indian Policy Landscape: National-level Electric Vehicle Policies.....	5
1.2.1 Faster Adoption and Manufacturing of (Hybrid) and Electric vehicles (FAME)	5
1.2.2 Business Models adopted by Energy Efficiency Service Limited (EESL).....	7
1.2.3 EV Charging Infrastructure: Guidelines and Standards by Ministry of Power, Government of India.....	8
1.2.4 Safety and Connectivity Standards for EV Charging Stations by CEA.....	10
1.2.5 ‘Model Building Bye-Laws’ for EV Charging Infrastructure, MoHUA	12
1.2.6 Guidelines by MoRTH for Promotion of Electric vehicles in India	13
1.2.7 Proposals for availing incentives under FAME-II for deployment of EV charging infrastructure.....	13
1.2.8 Union Budget Envisions India as a Global Hub for Manufacturing Electric vehicles..	15
1.3 Global EV Charging Standards and Protocols (AC and DC Chargers)	15
1.4 State-wise EV Policies and Regulatory Framework.....	16
1.4.1 State/ Union Territories-specific EV Charging Tariffs at a Glance.....	17
2.0 ANALYSIS OF EXISTING STUDIES ON EVS IN INDIA: MAJOR FINDINGS AND RECOMMENDATIONS	21
2.1 Technical challenges for DISCOMs.....	21
2.1.1 Peak power increase/ charging demand patterns.....	21
2.1.2 Power quality related issues.....	24
2.1.3 Integration issues of EVCI into the grid.....	24

2.1.4	Recommendations from the Reports/ Studies.....	26
2.2	Regulatory challenges for DISCOMs	28
2.2.1	Tariff structure for DISCOMs.....	28
2.2.2	Recommendations from Reports studied/ analyzed	29
2.3	Financial/ Business Models.....	30
2.3.1	Business Models	30
2.3.2	Recommendations	31
2.4	Research Gaps	33
3.0	SUMMARY OF INTERACTIONS WITH DISCOMS AND OTHER KEY STAKEHOLDERS	35
3.1	DISCOMs' Perspective	35
3.1.1	Technical/Operational Aspects	35
3.1.2	Financial Aspects.....	38
3.1.3	Regulatory and Policy-related Aspects	39
3.1.4	Recommendations	41
3.2.	Other Key Stakeholders' perspective	41
3.2.1	Perspective of Central Agencies	41
3.2.2	Perspectives of Oil Marketing Companies (OMCs)	43
3.3.3	Perspectives of Cab Aggregators	44
3.3.4	Perspectives of Charge Point Operators (CPOs).....	44
3.3.5	Perspectives of Original Equipment Manufacturer (OEMs)	45
3.3.6	Recommendations	46
4.0	IMPACTS OF EV CHARGING ON DISTRIBUTION NETWORK: INSIGHTS FROM MODELLING & SIMULATION STUDY FOR A SELECTED UTILITY AND ON-SITE PQ MEASUREMENTS.....	47
4.1	Purpose of the study and field-measurements.....	47
4.2	Modelling and Simulation Study on Smart Charging Management.....	47
4.2.1	Objective of the study	48
4.2.2	Methodology.....	48
4.2.3	Scenarios	54
4.2.4	Results and Observations.....	55
4.3	On-Site Power Quality Measurements	59
4.4	Effects of harmonics in the supply.....	60
4.5	Selection of utilities and site(s) for PQ measurement & analysis	60
4.5.1	Measurement & analysis of EV's chargers installed in parking lot of BRPL's Corporate Office.....	61
4.5.2	Measurement & analysis of EV's chargers installed at NDMC HQ, Palika Kendra in New Delhi	63

4.5.3	Measurement & analysis of EV's chargers installed at Kasba Bus Depot under WBTC in Kolkata, West Bengal.....	63
4.5.4	Observation(s) of DCFC (Steady state analysis for 24 hours measurement)	65
4.5.5	Observation(s) of DCSC (Steady state analysis for 24 hours measurement)	66
5.0	RECOMMENDATIONS & WAY FORWARD.....	69
	ABBREVIATIONS.....	69
	LIST OF MAJOR REFERENCES.....	71
Annexures	72
ANNEXURE 1:	LIST OF THE DISCOMS AS WELL AS OTHER KEY STAKEHOLDERS (PARTICIPATED DURING THE INTERACTIONS).....	72
ANNEXURE 2:	QUESTIONNAIRE FOR DISCOMS	73
ANNEXURE 3:	QUESTIONNAIRE FOR OTHER STAKEHOLDERS.....	75
ANNEXURE 4:	CASE-STUDY FOR RE PLUS BATTERY STORAGE BASED EV CHARGING.....	77
ANNEXURE 5:	DISCOMS INVESTMENT IN PCI: IMPACT ON END-USER TARIFF AND ARR	80
ANNEXURE 6:	SMART CHARGING SCHEME: RESULTS & OBSERVATIONS FOR SCENARIO 2.....	82

LIST OF ABBREVIATIONS

AC	:	Alternating Current
ANSI	:	American National Standards Institute
ARR	:	Annual Revenue Requirement
BEE	:	Bureau of Energy Efficiency
BEV	:	Battery Electric Vehicle
CCS	:	Combined Charging System
CEA	:	Central Electricity Authority
CERC	:	Central Electricity Regulatory Commission
CNG	:	Compressed Natural Gas
COCO	:	Company Owned Company Operated
CPO	:	Charge Point Operator
CVPR	:	Clean Vehicle Rebate Project
DC	:	Direct Current
DCFC	:	Direct Current Fast Charger
DCSC	:	Direct Current Slow Charger
DER	:	Distributed Energy Resource
DISCOM	:	Distribution Company
DSM	:	Demand Side Management
DTL	:	Delhi Transco Limited
DT	:	Distribution Transformer
EESL	:	Energy Efficiency Services Limited
EoI	:	Expression of Interest
EV	:	Electric Vehicle
EVCI	:	Electric Vehicle Charging Infrastructure
EVCS	:	Electric Vehicle Charging Station
EVSE	:	Electric Vehicle Supply Equipment

FAME	:	Faster Adoption and Manufacturing of (Hybrid) and Electric vehicles
GHG	:	Green House Gas
Gol	:	Government of India
ICE	:	Internal Combustion Engine
IEC	:	International Electrotechnical Commission
IEEE	:	Institute of Electrical and Electronics Engineers
IEX	:	Indian Energy Exchange
IGBT	:	Insulated Gate Bipolar Transistor
IIT	:	Indian Institute of Technology
INR	:	Indian National Rupee
IRR	:	Internal Rate of Return
LiB	:	Lithium Ion Battery
LoL	:	Loss of Life
LV	:	Low Voltage
MoHUA	:	Ministry of Housing and Urban Affaires
MoP	:	Ministry of Power
MoRTH	:	Ministry of Road Transport and Highways
MOSFET	:	Metal Oxide Field Effect Transistor
NCS	:	Nippon Charge Service
NEMA	:	National Electrical Manufacturers Association
NPV	:	Net Present Value
O & M	:	Operation and Maintenance
OEM	:	Original Equipment Manufacturer
OMC	:	Oil Marketing Company
OMI	:	Ola Mobility Institute
PCC	:	Point of Common Coupling
PCI	:	Public Charging Infrastructure
PCS	:	Public Charging Station
PESO	:	Petroleum and Explosives Safety Organization
PEV	:	Plug-in Electric Vehicle
PHEV	:	Plug-in Hybrid Electric Vehicle

PLF	:	Plant load factor
PPA	:	Power Purchase Agreement
PPP	:	Public Private Partnership
PQ	:	Power Quality
RO	:	Retail Outlet
SAE		Society of Automotive Engineers
SEP	:	Strategic Energy Plan
SLD	:	Single Line Diagram
SoC	:	State of Charge
SPV	:	Solar Photovoltaic
TCO	:	Total Cost of Ownership
THD	:	Total Harmonic Distortion
ToD	:	Time of Day
ToU	:	Time of Use
ULED	:	Ultra-Low Emission Discount
UT	:	Union Territory
V2B	:	Vehicle to Building
V2G	:	Vehicle to Grid
V2H	:	Vehicle to Home
VRE	:	Variable Renewable Energy
WACC	:	Weighted Average Cost of Capital
ZEV	:	Zero Emission Vehicle

LIST OF FIGURES

Figure 1:	Evolution of China's EV adoption programs.....	2
Figure 2:	Norwegian EV incentives development [Source: Norwegian EV Association]	2
Figure 3:	City-wise allocation of E-Buses under FAME-2 (current EoI from DHI)	7
Figure 4:	EESL's Business Models for Electric vehicles.....	7
Figure 5:	Standards for EV Charging Stations seeking for connectivity to the grid.....	11
Figure 6:	Allocation of EV Public Charging stations under EOI issued by DHI.....	14
Figure 7:	AC and DC Charging Techniques (Source: ABB).....	15
Figure 8:	Global overview of EV charger characteristics in key regions	16
Figure 9:	State Electric Vehicle policies at a glance.....	17
Figure 10:	Percentage changes in peak-demand due to EV charging	23
Figure 11:	Business models adopted in different countries.....	31
Figure 12:	Crucial factors supporting transition towards e-mobility.....	32
Figure 13:	Single Line Diagram of the test system	49
Figure 14:	Arrangement of EV charging stations placed on the DT network	49
Figure 15:	The EV charging characteristics modelled in the study.....	50
Figure 16:	Probability arrival and departure.....	51
Figure 17:	Probability of Distance travelled in a day.....	51
Figure 18:	IEX Rate.....	52
Figure 19:	Hour-Wise average IEX price.....	52
Figure 20:	loading on the DS, in scenario 1	55
Figure 21:	Charging power for 5 EVs under both UC and coordinated charging schemes for a day under scenario 1	56
Figure 22:	Base loading on DT1, Loading with UCC and CCEV charging and corresponding IEX prices for another day in scenario 1	57
Figure 23:	Base loading on DT2, Loading with coordinated and uncoordinated EV charging and corresponding IEX prices for a day in scenario 1	57

Figure 24:	Total charging costs for both UCC and CC schemes for a day under scenario 1.....	58
Figure 25:	(a) EV charging station in BRPL parking lot (b) Connection diagram of the facility providing supply to L2 and DCFC (c) EVs charging scenario	61
Figure 26:	Variation in per phase power observed at different time slots (1st DCFC on at 121st instant at 4:30 PM)	62
Figure 27:	Variation in degree of unbalance with time.....	62
Figure 28:	Variation in 3rd and 5th order current harmonic distortion at different instants	63
Figure 29:	(a) EV charging station in NDMC, New Delhi (b) PQ parameters obtained from on-site measurements	63
Figure 30:	(a) e-buses charging station in Kasba depot (b) Schematic diagram of facility providing power supply to EV chargers	64
Figure 31:	Variation in per phase power in different time slots.....	65
Figure 32:	Total harmonic distortion in phase current.....	65
Figure 33:	Variation in degree of current unbalance with reference to negative and zero sequence.....	66
Figure 34:	Variation in per phase power in different time slots.....	66
Figure 35:	Total harmonic distortion in phase current.....	67

LIST OF TABLES

Table 1: State-wise subsidy type and details on the purchase of Electric vehicles in the USA.....	3
Table 2: Category-wise incentives on ZEVs in the UK.....	4
Table 3: Policy initiatives and incentives for EVs in Japan.....	5
Table 4: Types of business models for EVCI implementation in a few countries.....	5
Table 5: Year-wise incentives under FAME-II.....	6
Table 6: Vehicle segment-wise incentives under FAME-II.....	6
Table 7: Combinations of EV Chargers as introduced by MoP, Government of India.....	8
Table 8: State Nodal Agencies appointed under the provisions of “Charging Infrastructure for Electric Vehicles – Guidelines and Standards” issued by Ministry of Power.....	9
Table 9: Safety Provisions for EV Charging Stations as defined in the CEA (Measures relating to Safety and Electric Supply) (Amendment) Regulations, 2019.....	11
Table 10: Various categories of charging stations introduced under FAME-II.....	13
Table 11: Definitions for three levels of EV charging.....	15
Table 12: Overview of EV charger characteristics in key regions across the globe.....	16
Table 13: State/Union Territory-specific EV Charging Tariff at a Glance.....	18
Table 14: Average & Peak EV charging load to grid.....	24
Table 15: Model for setting up DC fast chargers at Public parking spaces.....	25
Table 16: Viability assessment for setting up DC fast charging station.....	26
Table 17: EV Scenarios.....	54
Table 18: Summary of results.....	59
Table 19: Voltage distortion limits under IEEE 519.....	59
Table 20: Current distortion limits under IEEE 519.....	60
Table 21: AC & DC Chargers specification at Kasba bus depot, Kolkata.....	64

ACKNOWLEDGEMENT

This report would not have been possible without the cooperation and support received from the electricity Distribution Companies (DISCOMs) with whom the project team interacted individually as well as those who participated in the sixth meeting of Distribution Utilities Forum (DUF). We are grateful to Bangalore Electricity Supply Company Limited (BESCOM) for their unflinching support towards hosting this meeting and for sparing their valuable time in engaging with the project team in insightful deliberations on implementing electric vehicle charging infrastructure within the license areas of DISCOMs. We extend our thanks to CESC Limited, West Bengal State Electricity Distribution Company Limited (WBSEDCL), Maharashtra State Electricity Distribution Company Limited (MSEDCL), Gujarat Urja Vikas Nigam Ltd (GUVNL), Gujarat Energy Development Agency (GEDA), BSES Rajdhani Power Limited (BRPL), Tata Power Delhi Distribution Limited (TPDDL), BSES Yamuna Power Limited (BYPL), New Delhi Municipal Council (NDMC), Uttarakhand Power Corporation Limited (UPCL), Jaipur Vidyut Vitaran Nigam Limited (JVNL), Kerala State Electricity Board (KSEB), Madhya Pradesh Madhya Kshetra Vidyut Vitaran Company Limited (MPCZ) and MP Power Management Company Limited (MPPMCL) for providing their valuable time to the project team for detailed interactions.

We are extremely thankful to all the officials representing a diverse set of stakeholders such as oil marketing companies like Indian Oil Corporation Limited (IOCL) & Hindustan Petroleum Corporation Limited (HPCL), nodal ministries like Ministry of Power/ Department of Heavy Industry, central government agencies - mainly Energy Efficiency Services Limited (EESL) & Central Electricity Authority (CEA), Original Equipment Manufacturers (OEMs), Charge Point Operators (CPOs) and cab aggregators who spared time with the project team to share their perceptions, experiences and best practices in regard to the implementation of Electric Vehicle Charging Infrastructure (EVCI).

We thank Shakti Sustainable Energy Foundation (SSEF) for supporting this initiative and wish to record our gratitude in particular to **Mr. Vivek Sen**, Associate Director (Clean Power), **Ms. Gayatri Ramanathan**, Associate Director (Projects), **Ms. Chetna Nagpal**, Program Manager (Electric Mobility) and **Ms. Akanksha Golchha**, Program Manager (Electric Utilities) for their inputs during the course of this study.

We are also grateful to **Mr. Gireesh B Pradhan**, Honorary Chairperson, DUF & former Chairperson, Central Electricity Regulatory Commission (CERC) and **Mr. A. K. Saxena**, Senior Director & Senior Fellow, Electricity and Fuels Division, TERI, for their continued guidance and support in making this report focused on the purpose of the study. Support and guidance provided by **Mr. Ajay Shankar**, Distinguished Fellow, TERI, **Mr. K. Ramanathan**, Distinguished Fellow, TERI, **Mr. Amit Kumar**, Senior Fellow & Senior Director, Rural Energy and Livelihoods, TERI, **Er. Alekhya Datta**, Fellow and Area Convenor, Electricity and Fuels Division, TERI and **Mr. S. Narayan Kumar**, Fellow, Electricity and Fuels Division, TERI is also gratefully acknowledged.

About the Authors

This report has been authored by: Er. Alekhya Datta (Fellow & Area Convenor), Mr. Neshwin Rodrigues (Research Associate), Mr. Ram Krishan (Research Associate), Ms. Jyoti Sharma (Project Consultant), Mr. Mukesh Kumar (Project Associate), Mr. Ashish Rawat (Project Associate), Mr. Ashish Kumar Sharma (Research Associate) and Dr. Shashank Vyas (Associate Fellow) of Electricity & Fuels Division, TERI.

EXECUTIVE SUMMARY

The transport sector relies heavily on Internal Combustion Engine (ICE) based vehicles that use fossil fuels as the source of energy for propulsion. These vehicles add to the environmental and human health-related issues arising out of the release of toxic gases as tailpipe emissions. Transitioning towards electric vehicles (EVs) can thus be a formidable step towards reducing Green House Gas (GHG) emissions and in laying down a path towards green transportation and sustainable mobility. Globally, various countries have come up with policies, schemes and incentives for facilitating a phase-wise transition towards EVs in combatting climate change. Keeping in mind the rise in GHG emissions, mainly through vehicular exhaust, the Department of Heavy Industry (DHI), Government of India launched the Faster Adoption and Manufacturing of Electric vehicles in India (FAME India), Phase-II scheme with an outlay of Rs. 10,000 crore. In-order to promote EVs to curb air pollution in major cities of India, the 36th meeting of the Goods and Service Tax (GST) Council, held on July 27, 2019, announced some major tax relaxations for EVs. 'Make-In-India' giga-factories have been announced to further drive cost reduction in advanced batteries to be used in such vehicles. To accelerate faster deployment of EVs and eliminate 'range-anxiety', the Ministry of Power (MoP), Government of India, formulated 'Charging Infrastructure for Electric vehicles – Guidelines & Standards' (notified on December 14, 2018) for establishment of Public Charging Station (PCS) in selected cities and highway corridors. As per the revised guidelines, released on October 1, 2019, Bureau of Energy Efficiency (BEE) has been appointed as the 'Central Nodal Agency' for rollout of EV public charging infrastructure and 25 state nodal agencies have been appointed for various states/Union Territories (UTs) as of 18 May, 2020. In-order to implement the policy, the DHI recently floated an Expression of Interest (EoI) for availing incentives under phase II of the FAME-India scheme for deployment of EV charging infrastructure within cities. Recently, the Ministry of Housing and Urban Affairs (MoHUA), Government of India, amended the 'Model Building Bye-Laws' in-order to provide dedicated space for Electric Vehicle Charging Infrastructure (EVCI) in new and existing buildings.

To facilitate a sustainable electric mobility ecosystem in India, the role of power utilities will be a leading one, especially in deploying EVCI within their license areas. It thus becomes crucial to gauge the outlook of the DISCOMs towards e-mobility and understand their concerns. Many studies carried out so far on assessing the technical, financial and regulatory aspects of electric mobility in India project considerable impacts on the distribution system due to large-scale penetration of EVs. These impacts have been anticipated in the form of overloading of Distribution Transformers (DTs), network congestion, power quality distortions and peak power procurement issues. However, as one of the findings suggest, the increased load due to EV charging can be controlled by implementing smart charging schemes that help in facilitating Demand Side Management (DSM) through a Time of Day (ToD) or Time of Use (ToU) tariff structure.

Therefore, considering these propositions and other immediate possibilities like different business models for revenue realization of involved stakeholders, declaring EVCI as a separate consumer category while defining the applicable ToD/ToU tariff, formulation of dynamic pricing or real time pricing as some of the solutions proposed to manage EV charging, a bottom-up approach was adopted in this study by consulting various entities involved apart from DISCOMs. Therefore, the objective of this study was

to primarily understand the DISCOMs' perspective towards EVs with an overall comprehension of the issues that they anticipate and how they plan to address them. In-order to understand the problems from an overall perspective and to find-out possible and comprehensive solutions, interactions with other relevant stakeholders such as nodal ministries/ agencies, oil marketing companies (OMCs), charge-point operators (CPOs), cab aggregators and vehicle OEMs were also organized.

Stakeholder-specific questionnaires were designed, and interactions were held in person, or over phone wherever a visit was not possible. The questions for the DISCOMs were formulated on three aspects: technical, financial and regulatory while the same structure was followed for the other stakeholders including some additional points relevant to a particular category of stakeholder. Interesting insights emerged from the interactions and they have been organized as a series of observations in chapter 3. One of these prominent observations was the fact that even though some DISCOMs perceived that their networks in the current form are capable of catering to the load in the near future, they underlined the importance of carrying out planning studies in regard to accommodating EV charging load considering network congestion. Further, it emerged that while communication infrastructure is crucial for EVCI implementation, DISCOMs' concerns centered around the apportionment of the cost of installation and commissioning of equipment to set up this infrastructure.

Besides these issues, peak power procurement due to increased EV load, suitable revenue models needed to support network strengthening and government grants from both the state and central levels were also suggested by DISCOMs as pressing issues. Since the EV ecosystem involves a lot of other stakeholders like vehicle OEMs, CPOs, fleet operators, their views were also sought and they outlined technical, financial and regulatory issues regarding EVCI implementation from their perspective. As far as the technical aspects are concerned, these stakeholders perceived challenges such as provision of adequate power infrastructure for Electric Vehicle Charging Stations (EVCS) to cater to EV charging load, utilization of chargers/EVCS, effective parking space for EVCS etc. Revenue realization from EV charging and suitable policy and regulations for implementing the roll out of EVCI was an important concern expressed by them.

The operational management of EV charging is essential for determining the impacts on the power network and assessing the associated financial implications too. Hence it was felt that a detailed study on analyzing the impacts of coordinated EV charging on network management for a DISCOM was important and accordingly a modeling and simulation study was performed. The report also presents a set of power quality measurements taken at a few sites to showcase the effect of random EV charging on the local power quality of the distribution network. Important insights from these set of studies and measurements related to how network congestion and local transformer loading should be reflected in EV charging tariffs, how charging cost and network operation can be optimized using coordinated charging, and what are the effects of charging pattern on power quality respectively were brought out. Additionally, a portion of this report also presents an economic assessment of DISCOMs' investment in EVCI and showcases the benefits from charging EVs with and without ToD tariff.

1. GLOBAL AND INDIAN ELECTRIC MOBILITY SCENARIO

1.1 Electric Mobility & Charging Infrastructure: Global Outlook

The global average surface temperature has risen by about 1.62 degrees Fahrenheit (0.9 degree Celsius) since the late 19th century, a change driven largely by increased carbon dioxide and other human-made emissions into the atmosphere¹. Transportation has immensely contributed to the Greenhouse Gas (GHG) emissions mainly through vehicular exhaust. Thus, transitioning towards EVs can be a significant step in the direction of reducing global GHG emissions and bringing in green transportation and sustainable mobility. In 2018, over 2 million electric vehicles were added to the global vehicle fleet, with currently over 5 million EVs on the roads globally². The battery prices drive one-third of the cost of an EV and hence continuous reduction in the battery prices will help customers in wide-scale adoption. The rapid decline in Lithium Ion Battery prices from \$1,100 per kWh in 2010 to \$156 kWh in 2019 has been experienced³ as a global spectacle. The reduction in average battery pack prices is projected to reach upto \$87/kWh in 2025 and \$62/kWh in 2030⁴.

Policymakers across the globe are trying to push the future towards low carbon transport and automakers are increasing their commitments to bring new models on zero-emission vehicles. The consumer awareness and orientation towards Electric Mobility is also catching up. India is one of the fastest growing economies in the world, however, it still is concerned by issues like dependency on fossil fuels that can potentially impact its vulnerability to global warming and its effects. According to World Energy Outlook 2018 of the International Energy Agency (IEA), the Indian transportation sector accounted for over 40% of the total oil consumption in the World, highlighting a considerable share in global carbon emissions. Recently, the Government of India (GoI) took various initiatives in-order to reduce these emissions by introducing several programs for supporting electric mobility. Globally, various countries have come up with policies, schemes and incentives for facilitating a phase-wise transition towards electric vehicles in combatting climate change. Some of those efforts by various countries have been covered in this chapter.

1.1.1 China

China is currently dominating the EV market due to aggressive policy supported-push at both the national and regional levels. According to Bloomberg, as per their recent report, there is a projection of 7million (nearly 25% of total vehicle stock) sales of EVs in China by 2025⁵. The main reasons behind China supporting the transition to electric mobility are seriousness towards climate change; most of the oil used in the country is being imported and increasing air pollution levels which is affecting quality of life. These have catalyzed an industry-friendly policy support towards push for EVs (refer figure 1).

¹ Climate Change: How Do We Know? Source: <https://climate.nasa.gov/evidence/>

² Bloomberg New Energy Finance: EV Outlook Report 2019

³ Bloomberg New Energy Finance: Battery Pack Prices Fall as Market Ramps Up With Market Average at \$156/kWh In 2019. Source: <https://about.bnef.com/blog/battery-pack-prices-fall-as-market-ramps-up-with-market-average-at-156-kwh-in-2019/>

⁴ Bloomberg NEF: Energy and Mobility Transition 2019

⁵ China Raises 2025 Electrified-Car Sales Target to About 25%. Bloomberg News. December 2019. Source: <https://www.bloomberg.com/news/articles/2019-12-03/china-raises-2025-sales-target-for-electrified-cars-to-about-25>

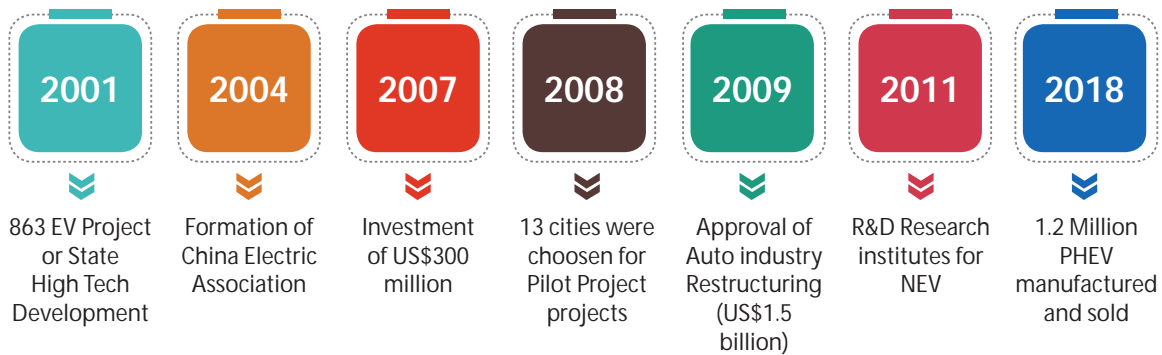

Figure 1: Evolution of China's EV adoption programs

Utilities like State Grid Corporation of China and China Southern Power Grid have together opened more than 27,000 charging stations across the country, as well as more than 800 electric vehicle battery-swapping stations for buses.

1.1.2 Norway

Norway has one of the most favorable incentive structures for electric vehicles (EVs) across the globe. Renewable energy sources are responsible for 98% of power generation within which hydro power accounts for 95% of the total installed capacity (Norwegian Water Resources and Energy directorate, 2018). There is no dedicated electric vehicle strategy but rather a series of policy interventions and programs, variously contained in climate policy documents, national transport strategies and budget plans that are designed to encourage adoption of EVs. The Norwegian EV incentives started to evolve way back in the 1990s (figure 2) in-order to provide initial support to the Norwegian EV industry. Many of the charge point operators were local distribution utilities who had applied for funding under the initial budgetary support for fast charging equipment.

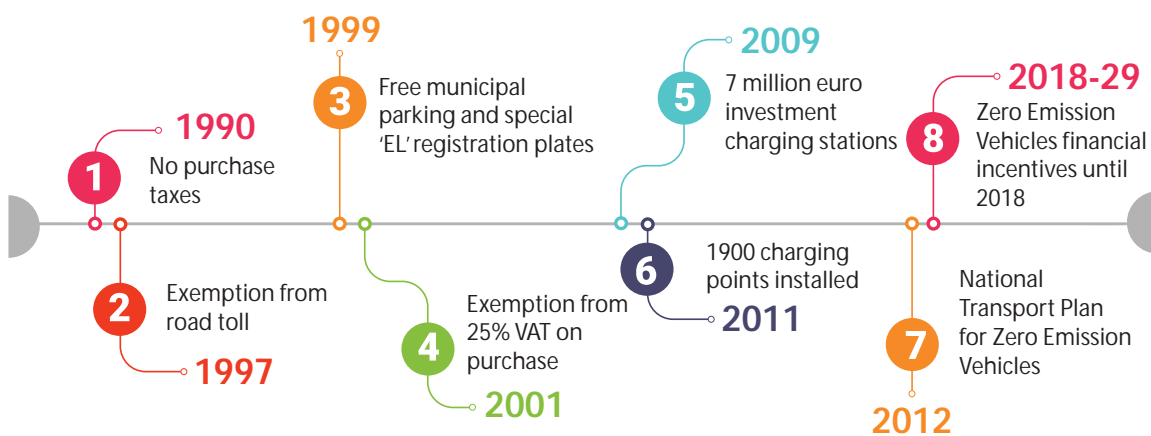

Figure 2: Norwegian EV incentives development (Source: Norwegian EV Association⁶)

⁶ Norwegian EV policy. Source: <https://elbil.no/english/norwegian-ev-policy/>

Incentives were provided in-order to support the purchase and use of zero emission vehicles (ZEVs). These vehicles are exempted from registration tax since 1990 and from VAT on purchase since 2001. In 2017, PHEVs were granted with a 26% reduction in registration tax as a deduction on the calculation of the weighted tax. Large generation or transmission companies have been most proactive in building EVSE, but local municipal utilities have also launched their own projects in some parts of Norway.

1.1.3 United States of America

The subsidies on electric vehicles in the United States of America (USA) are present at the state as well as national levels. The idea behind the transition to EVs has been strong enough such that government policies that have been designed to encourage the adoption of electric vehicles exist at the federal, state, and local level in the United States (refer to table 1). The government of the USA granted federal tax credits from \$2500 to \$7500 for new qualified plug-In EVs manufactured during and after 2010⁷. California was the first state to initially fund Clean Vehicle Rebate Project (CVPR) with a total of \$4.1 million in order to promote the production and usage of Zero Emission Vehicles (ZEVs).

Table 1: State-wise subsidy type and details on the purchase of Electric vehicles in the USA

State	Subsidy Type	Description	Start	Expires
Connecticut	Rebate – Electric vehicle	Rebate offered up to \$3,000 for a new EV purchase.	5/19/2015	N/A
Massachusetts	Rebate – Electric vehicle	Rebate offers up to \$2,500 for a new EV purchase. The rebate is reduced for vehicles priced at over \$60,000.	6/1/2014	N/A
Colorado	Tax credit – Electric vehicle	Offers a \$5,000 credit for purchase of a new EV and \$2,500 for lease. These values are set to decrease in 2020 and 2021.	1/1/2017	1/1/2022
Louisiana	Tax credit - Electric vehicle	This credit offers 7.2% of vehicle cost up to \$1,500.	7/1/2009	1/1/2018
New York	Tax credit – Electric vehicle	Offers up to \$2,000 for a new EV purchase. Reduced credit for vehicles priced at over \$60,000.	1/1/2017	N/A

⁷ Internal Revenue Bulletin: 2009-48. United States Government. November 30, 2009. https://www.irs.gov/irb/2009-48_IRB

The significant charge point operators in the United States are mostly private players, oil companies and some utilities like ChargePoint, Shell and Pacific Gas and Electric (PG&E) . Each electric vehicle charging network has its own system with memberships.

1.1.4 United Kingdom

The purchase incentives under the Plug-in grant started by the UK government in January 2011 cover 25% grant towards the cost of new plug-in cars capped at GBP 5,000. In April 2015, the government raised this cap to 35% of the purchase price for both private and business fleets⁸. In February 2015, the government updated the plug-in grant criteria banding based on Zero Emission Vehicle (ZEV) capability. The incentives on ZEVs are categorized in three categories ⁹ (refer to Table 2).

Table 2: Category-wise incentives on ZEVs in the UK

S.No.	Category	Incentive
1.	Vehicles that have CO ₂ emissions of less than 50g/km and can travel at least 112km (70 miles)	Maximum purchase incentive of £3,500.
2.	Vehicles that have CO ₂ emissions of less than 50g/km and can travel at least 16km (10 miles)	£500 (including VAT) off the cost of installing a home charger
3.	Vehicles that have CO ₂ emissions of 50 to 75g/km and can travel at least 32km (20 miles)	£500 (including VAT) off the cost of installing a home charger

All Battery Electric Vehicle (BEVs) and Plug-In electric vehicles qualify for 100% discount from London congestion charges according to the government of UK from February 2015. The original Greener Vehicle Discount was substituted by the Ultra-Low Emission Discount (ULED) scheme that went into effect from 1st July 2013¹⁰. Also, utilities are playing major role in collection of data on charger usage, both public and private to manage power flows of the grid better. However, distribution network operators are not allowed to own or operate ‘behind-the-meter’ infrastructure such as EV supply equipment or energy storage.

1.1.5 Japan

Japan lacks in natural resources and is highly dependent on imports of primary energy supply. The island nation introduced the “Clean Energy Vehicle” program in the year 1998, which provides subsidies and tax exemptions on the purchase of electric, natural gas and methanol and hybrid electric vehicles¹¹ (refer to table 3). The Development Bank of Japan collaborated with a number of vehicle manufacturers and the power utility TEPCO to develop the Nippon Charge Service (NCS) charging stations network all over the country.

⁸ Green Car Congress. UK Government Announces £5,000 Grants Towards Purchase of Electric Drive Vehicles and First “Plugged-in Places”. February 2010. More details at: <https://www.greencarcongress.com/2010/02/uk-ev-20100226.html>

⁹ <https://transportevolved.com/2015/02/13/uk-government-announces-changes-plug-car-incentives-introduces-banding-based-zev-capabilities/>

¹⁰ Mayor of London. Congestion Charge - Ultra Low Emission Discount. 2014. Source: <https://www.london.gov.uk/questions/2014/5137>

¹¹ Max Ahman, “Government policy and the development of electric vehicles in Japan”, Energy Policy, Vol. 34, Issue 4, pages 433-443, March 2016.

Table 3: Policy initiatives and incentives for EVs in Japan

S. No.	Policy Initiatives	Incentives
1.	Next Generation Automobile Industry Strategy, goal of having 15–20% EVs in 2020 and 20– 30% EVs of in 2030 passenger vehicle market	Purchase incentives for consumers
2.	Strategic Energy Plan (SEP) promotes a low-carbon transportation sector to strengthen Japan's energy security and shows a way to reduce Japan's consumption of fossil fuels, 2014	Reduction in acquisition tax (VAT)
3.	Japan Revitalization Strategy (JRS) is based on a theme of realizing clean and economic energy supply and demand and was launched in 2015	Exemption from an annual tonnage tax during the first year
4.	The Tokyo government, in order to cover the remaining cost of charging infrastructure after the national subsidy, has announced plans to include one billion Yen in the fiscal 2018 budget.	Support to manufacturers and investment in R&D

Utilities in Japan have built extensive charging networks. It is mainly in Japan where regulations on utility ownership of EVSE are becoming less stringent. Table 4 summarizes the EV charging business models prevalent in the set of countries discussed in this chapter.

Table 4: Types of business models for EVCI implementation in a few countries

Type of business model	China	Norway	USA	United Kingdom	Japan
Free public charging from CPO	✓	✓	✓	✓	✓
Pay per click model	✓	✓	✓	✓	✓
Subscription model	✓		✓	✓	✓
Pay per Minute Charging Model		✓		✓	
CPO provides charging at utility rates			✓		
Free Charging but fixed parking fee			✓		

1.2 Indian Policy Landscape: National-level Electric Vehicle Policies

1.2.1 Faster Adoption and Manufacturing of (Hybrid) and Electric vehicles (FAME)

The FAME scheme was launched in April 2015 with the agenda to ramp up and meet the goals of National Electric Mobility Mission 2020. Phase II of FAME¹² was initiated on April 1, 2019 based on the outcomes

¹² Officememorandum.PhaseIIofFAMEIndiascheme.March2019.Source:<https://dhi.nic.in/writereaddata/UploadFile/publicationNotificationFAME%20II%208March2019.pdf>

and experience gained during Phase I from stakeholders for implementation along with appropriate allocation of funds. The incentives under FAME-II are given in table 5.

Table 5: Year-wise incentives under FAME-II

S No.	Component	2019-20 (Rs. Crore)	2020-21 (Rs. Crore)	2021-22 (Rs. Crore)	Total Fund requirement (Rs. Crore)
1.	Demand Incentives	822	4,587	3,187	8,596
2.	Charging Infrastructure	300	400	300	1,000
3.	Administrative Expenditure including Publicity, ICE activities	12	13	13	38
	Total for FAME-II	1,134	5,000	3,500	9,643
4.	Committed expenditure of Phase 1	366	0	0	366
	Total	1,500	5,000	3,500	10,000

Vehicle segment-wise incentives and maximum number of vehicles to be supported under FAME-II are given in table 6.

Table 6: Vehicle segment-wise incentives under FAME-II

S. No.	Vehicle Segment	Maximum Number of Vehicle to be supported	Size of battery (kWh)	Total Incentive @10,000/ kWh & 20,000/ kWh for Buses	Maximum price to avail incentive	Total Fund
1.	e 2-Wheelers	10,00,000	2	Rs. 20,000	Rs. 1.5 Lakh	Rs. 2,000 Cr
2.	e 3-Wheelers	5,00,000	5	Rs. 50,000	Rs. 5 Lakh	Rs. 2,500 Cr
3.	e 4- Wheelers	35,000	15	Rs. 1,50,000	Rs. 15 Lakh	Rs. 525 Cr.
4.	4-W Strong Hybrid Vehicle	20,000	1.3	Rs. 13,000	Rs. 15 Lakh	Rs. 26 Cr
5.	e-Bus	7,090	250	Rs. 50 Lakh	Rs. 2 Cr.	Rs 3,545 Cr.
Total						Rs. 8,596 Cr.

Under the FAME-II India scheme, the government intended to support 7,090 electric buses, with a total expenditure of Rs. 3,540 crore. Recently, DHI allotted 5,595 e-buses out of total 7,090 buses for respective states (refer to figure 3 for city-wise allocation). The maximum demand incentives on batteries that can be availed from DHI under FAME-II depend on the bus length which is categorized as a) Standard Bus (length > 10 m to 12 m): Rs. 55 Lakh b) Midi Bus (length > 8 m to 10 m): Rs. 45 Lakh c) Mini Bus (length > 6 m to 8 m): Rs. 35 Lakh.

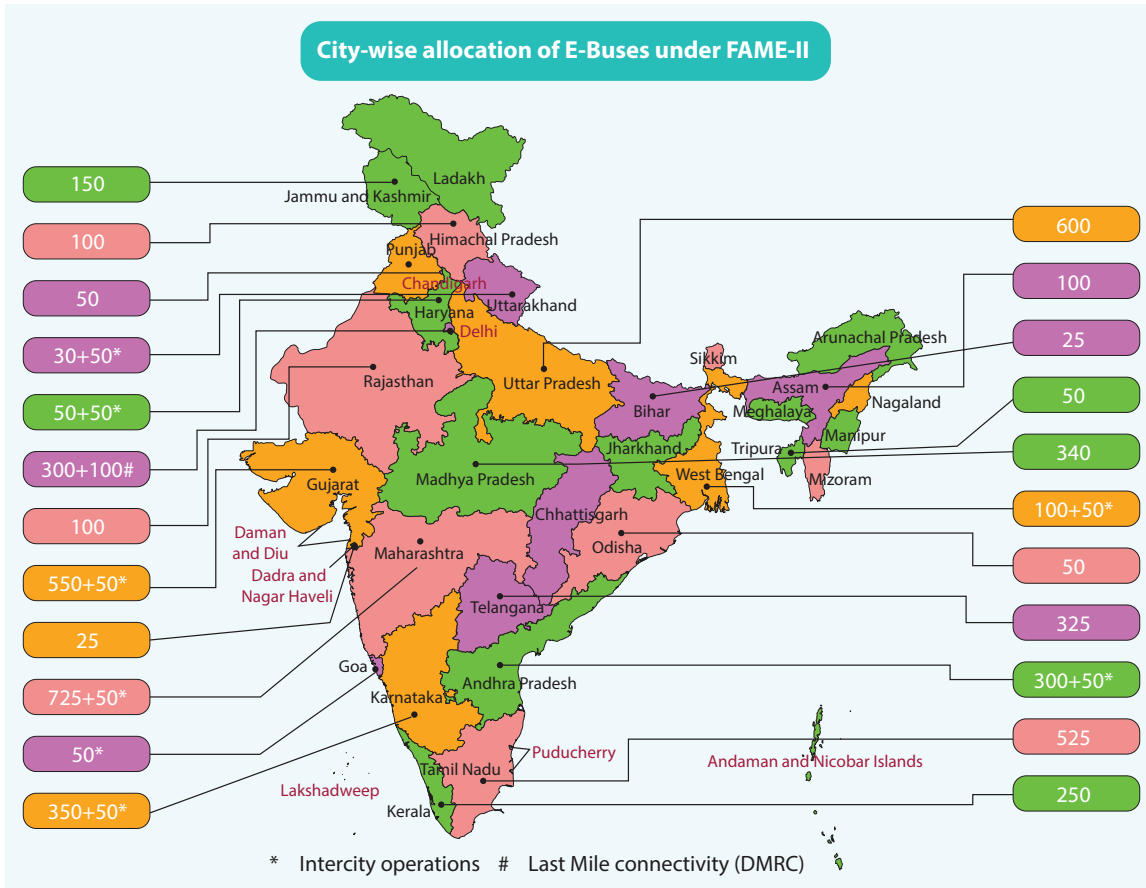

Figure 3: City-wise allocation of E-Buses under FAME-II (Source: TERI analysis based on data from current EoI from DHI)

1.2.2 Business Models adopted by Energy Efficiency Service Limited (EESL)

EESL came up with three business models i.e., wet lease, dry lease and outright purchase of electric 4-wheelers for various Central and State Government departments/ offices. EESL also floated a tender for 10,000 electric cars. EESL procured vehicles are compatible with Bharat EV Charger AC-001 and DC-001 specifications. However, CHAdeMO and CCS are also being opted for future purchase.

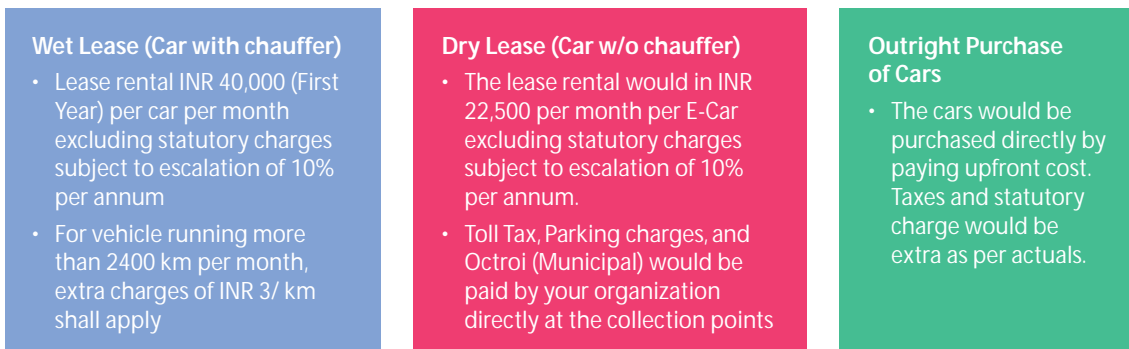

Figure 4: EESL's Business Models for Electric vehicles¹³

¹³ EESL April Newsletter. Source: https://www.eeslindia.org/content/raj/eesl/en/MEDIA-CORNER/Newsletter_2019.html

1.2.3 EV Charging Infrastructure: Guidelines and Standards by Ministry of Power, Government of India

The Ministry of Power (MoP) vide their order dated 13th April 2018 clarified that EV battery charging, as an activity, does not require any license under the provisions of the Electricity Act, 2003¹⁴. Furthermore, the 'Charging Infrastructure for Electric vehicles – Guidelines & Standards' notified by the MoP on 14th December, 2018 also clarified that setting up a PCS shall be a de-licensed activity. The revised guidelines¹⁵ were released on 1st October, 2019. The objectives of the guidelines are:

- a. To enable faster adoption of electric vehicles in India by ensuring safe, reliable, accessible and affordable charging infrastructure and eco-system
- b. To promote affordable tariff chargeable from EV owners and charging station operators/owners
- c. To generate employment/income opportunities for small entrepreneurs
- d. To proactively support creation of EV charging infrastructure in the initial phase and eventually create market for EV charging business
- e. To encourage preparedness of the electrical distribution system to adopt EV Charging Infrastructure (EVCI)

According to the guidelines, every public charging station should have an exclusive transformer, 33/11 kV lines with associated equipment and adequate space for charging of vehicles including their entry/exit. The charger combinations are given in table 7.

Table 7: Combinations of EV Chargers as introduced by MoP, Government of India

Charger Type	S No.	Charger Connectors*	Rated Output Voltage (V)	No. of connector guns (CG)	Charging vehicle type (W=wheeler)
Fast	1	Combined Charging System (CCS) (min 50 kW)	200-750 or higher	1 CG	4W
	2	CHArge de Move (CHAdeMO) (min 50kW)	200-500 or higher	1CG	4W
	3	Type-2 AC (min 22kW)	380-415	1CG	4W, 3W, 2W
Slow/ Moderate	4	Bharat DC-001 (15 kW)	48	1CG	4W, 3W, 2W
	5	Bharat DC-001 (15 kW)	72 or higher	1 CG	4W
	6	Bharat AC-001 (10 kW)	230	3 CG of each 3.3 kW each	4W, 3W, 2W

*in addition, any other fast/slow/moderate charger as per approved BIS standards when notified

¹⁴ https://powermin.nic.in/sites/default/files/webform/notices/Clarification_on_charging_infrastructure_for_Electric_Vehicles_with_reference_to_the_provisions_of_the_Electricity_Act_2003.pdf

¹⁵ Ministry of Power. Charging Infrastructure for Electric Vehicles (EV) - Revised Guidelines & Standards. October 1, 2019. Source: https://powermin.nic.in/sites/default/files/webform/notices/Charging_Infrastructure_for_Electric_Vehicles%20_Revised_Guidelines_Standards.pdf

As per the revised guidelines, for public charging of long range EVs, fast chargers should meet the criteria of having at least two chargers of minimum 100 kW rating (200-750 V or higher) with different specifications (CCS/ CHAdeMO/ any other fast charger approved by DST/BIS). Also, the system should have appropriate liquid cooled cables for providing high speed charging. As per the guidelines, one public charging station should be available in a grid of 3x3 km² range and one charging station on both sides of highways at every 25 km. The priority for rollout of EV public charging infrastructure is categorized in two phases. During Phase-1 (1-3 Years), all mega cities with population of 4 million plus and all existing expressways connected to mega cities & important highways will be targeted. Phase-II (3-5 Years) will be rolled out in big cities like state capitals and UT headquarters for distributed and demonstrative effect.

Utilities have been advised to make a proper database of public charging stations, conforming to appropriate protocols, which will be finally accessed by the Central Electricity Authority (CEA) and Ministry of Power. The domestic tariff will be applicable for domestic EV charging. For public charging, separate metering arrangement will be applicable and separate EV category tariff will be determined by the commission in accordance with Tariff Policy issued under Section 3 of Electricity Act 2003. The BEE will be the central nodal agency to act as the key facilitator in installing charging infrastructure. As of May 18, 2020, 25 State Nodal Agencies (SNAs)¹⁶ have been appointed in various states/ UTs which include mostly state-owned DISCOMs (refer to Table 8).

Table 8: State Nodal Agencies appointed under the provisions of “Charging Infrastructure for Electric Vehicles – Guidelines and Standards” issued by Ministry of Power

S. No.	State	State Nodal Agency (SNA)
1.	Andhra Pradesh	New and Renewable Energy Development Corporation of Andhra Pradesh (NREDCAP)
2.	Gujarat	Gujarat Energy Development Agency (GEDA)
3.	Himachal Pradesh	Himachal Pradesh State Electricity Board Limited (HPSEBL)
4.	Karnataka	Bengaluru Electricity Supply Company Limited (BESCOM)
5.	Meghalaya	Meghalaya Power Distribution Corporation Limited (Me-PDCL)
6.	Mizoram	Power & Energy Department, Government of Mizoram
7.	Odisha	E.I.C (Elect.)-cum PCEI Odisha, Bhubaneswar
8.	Punjab	Punjab State Power Corporation Limited (PSPCL)
9.	Rajasthan	Jaipur Vidyut Vitran Nigam Limited (JVVNL)
10.	Uttarakhand	Uttarakhand Power Corporation Limited (UPCL)
11.	Telangana	Telangana State Renewable Energy Development Corporation Ltd (TSREDCO)
12.	West Bengal	West Bengal State Electricity Distribution Company Limited (WBSEDCL)

¹⁶ Bureau of Energy Efficiency. State Nodal Agencies under the provision of “Charging Infrastructure for Electric Vehicles-Guidelines and Standards” issued by Ministry of Power on 14.12.2018. Available at: <https://beeindia.gov.in/press-releases/state-nodal-agencies-under-provision-%E2%80%9Ccharging-infrastructure-electric-vehicles>

S. No.	State	State Nodal Agency (SNA)
13.	Delhi	Delhi Transco Limited (DTL)
14.	Lakshadweep	Lakshadweep Energy Development Agency (LEDA)
15.	Jammu & Kashmir	EM&RE Wing Jammu as “Nodal Agency for Jammu Division”; Kashmir “Nodal Agency for Kashmir Division” and Ladakh “Nodal Agency for Ladakh”
16.	Kerala	Kerala State Electricity Board Ltd (KSEB)
17.	Madhya Pradesh	M.P.Power Management Co. Ltd (MPPMCL)
18.	Haryana	Uttar Haryana Bijli Vitran Nigam Limited (UHBVN)
19.	Andaman & Nicobar	Director of Transport
20.	Sikkim	Power Department, Sikkim
21.	Arunachal Pradesh	Central Electrical Zone, Dept. Of Power, Itanagar
22.	Bihar	Transport Department, Patna
23.	Tamil Nadu	Tamil Nadu Generation and Distribution Corporation Limited
24.	Puducherry	Electricity Department
25.	Chhattisgarh	Transport Department, Raipur

1.2.4 Safety and Connectivity Standards for EV Charging Stations by CEA

The MoP guidelines for EV charging infrastructure majorly focus on building an ecosystem of charging infrastructure which can be easily accessible, safe and reliable for a user. Simultaneously, the CEA also made timely amendments in its existing relevant connectivity & safety regulations to include EVs. CEA had proposed amendments to two of its existing regulations to include various provisions relating to EV charging and relevant safety standards. The amended regulations were notified in 2019.

On 6th February, 2019, the Central Electricity Authority (Technical Standards for Connectivity of the Distributed Generation Resources) Amendment Regulations, 2019¹⁷, amending the regulations of 2013, were notified. These amended regulations included definitions for ‘charging points’ and ‘charging stations’ as applicable to EVs based on voltage-levels and nature of usage respectively. Certain standards for charging stations were also added mentioning connectivity rules and prescribing compliance to certain international standards relating to power quality. Some of these provisions added in the amended regulations of 2019 for seeking connectivity of EV charging stations to the electricity system are presented in figure 5.

¹⁷ Central Electricity Authority, Notification to Central Electricity Authority (Technical Standards for Connectivity to the Grid) (Amendment) Regulations, 2019. February 2019. Available at: http://cea.nic.in/reports/others/god/gm/notified_regulations.pdf

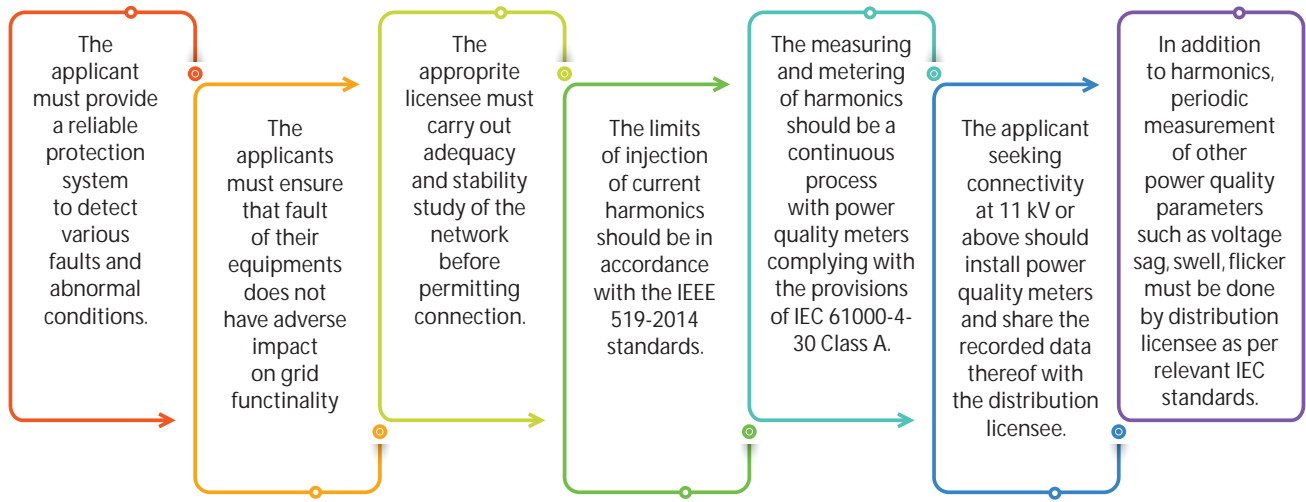

Figure 5: Salient points of the amended regulations for EV Charging Stations seeking connectivity to the grid

On 28th June, 2019, the Central Electricity Authority (Measures relating to Safety and Electric Supply) (Amendment) Regulations, 2019¹⁸ were notified, amending regulations on the subject notified in 2010. The amendment introduced safety provisions for EVCS including general safety requirements, Earth-protection system and fire-protection requirements for EVCS. The amended regulations also mandated testing, inspection and periodic assessment of charging stations apart from maintenance of records. This amendment to the 2010 regulation also added the definitions for charging point, charging stations, electric vehicles, EVSE, socket outlet and supply lead with the above-mentioned safety provisions. These safety provisions were introduced in the form of a new chapter titled “Safety provisions for Electric Vehicle Charging Stations” and mentioned the various aspects related to EV charging stations such as testing, inspection, maintenance, safety & fire protection measures. The safety requirements (electrical and fire safety) along-side standards related to testing & maintenance of EV charging stations have been summarized in table 9.

Table 9: Safety Provisions for EV Charging Stations as defined in the CEA (Measures relating to Safety and Electric Supply) (Amendment) Regulations, 2019

S. No	Basic requirements for EVCS	Recommendations
1.	General Safety Requirements	<ul style="list-style-type: none"> i. EV charging stations should provide protection against the overload of input supply ii. Socket-outlet should be at least 800 mm above ground level iii. Parking place should be within five meters of connection on the vehicle iv. The station should also be equipped with protective device against reverse power flow v. Charging stations should follow Indian Standards Code IS/ IEC 62305 for lightning protection

¹⁸ Central Electricity Authority. Notification. Central Electricity Authority (Measures relating to Safety and Electric Supply) (Amendment) Regulations, 2019. June 2019. Available at: http://www.cea.nic.in/reports/regulation/measures_safety_2019.pdf

S. No	Basic requirements for EVCS	Recommendations
2.	Earth protection system	<ul style="list-style-type: none"> i. Residual current devices for the protection should have a performance equal to Type A in conformity with IS 732-2018. ii. Residual current should not exceed above 30mA iii. Earthing of an EV charging stations should be as per IS 732
3.	Requirements to prevent fire	<ul style="list-style-type: none"> i. Enclosure of charging stations should be made of fire-retardant material with self-extinguishing property ii. The charging stations must be equipped with fire detection, alarm and free from Halogen. iii. Power supply cables used in charging station should follow IEC 62893-1 and its relevant parts.
4.	Testing of charging stations	<ul style="list-style-type: none"> i. Apparatus of charging stations should have the insulation resistance value as stipulated in IEC 61851-1.
5.	Inspection and periodic assessment	<ul style="list-style-type: none"> i. Every charging station must be tested and inspected by the owner every year in the initial period of first three years.
6.	Maintenance of records	<ul style="list-style-type: none"> i. The owner should keep records in regard of design, construction and labelling to be compatible with a supply of standard voltage at a frequency of 50 Hz. ii. The owner of the charging station shall keep records of the relevant test certificate as per IEC 61851.
7.	International Standard for charging stations	<ul style="list-style-type: none"> i. Charging stations should follow safety provisions for AC charging stations as per IEC 61851-1, IEC 61851-21 and IEC 61851-22 standards ii. DC charging stations should follow safety provisions as per IEC 61851-1, IEC 61851-21, IEC 61851-23 and IEC 61851-24 standards

1.2.5 'Model Building Bye-Laws' for EV Charging Infrastructure, MoHUA

On February 15, 2019, the MoHUA came up with an amendment¹⁹ required for charging Infrastructure provisions in Development Control Regulations and enabling provisions for installing 'Charging Infrastructure' in the building premises and core urban areas of the cities. Based on the occupancy pattern and the total parking provisions in the premises of the various building types, charging infrastructure shall be provided only for EVs, which is currently assumed to be 20% of all vehicle holding capacity or 'parking capacity' at the premises.

¹⁹ Ministry of Housing & Urban Affairs. Amendments in Model Building Bye-Laws for Electric Vehicle Charging Infrastructure. February 2019. Available at: [http://mohua.gov.in/upload/whatsnew/5c6e472b20d0aGuidelines%20\(EVCI\).pdf](http://mohua.gov.in/upload/whatsnew/5c6e472b20d0aGuidelines%20(EVCI).pdf)

For residential buildings (plotted houses) minimum one AC slow charger is to be installed compulsorily on the premises with a domestic meter connection. As per minimum requirement specified by MOP for all other buildings (including housing groups) one 1 FC & 1 SC on each 10 & 3 four-wheeler EVs, 1 SC on each 3-wheeler EV, 1 SC on each 2 two-wheeler EVs with commercial metered connection needs to be install in every premises. Under this policy the fuel filling stations (including COCO outlets) shall also conform to specifications and safety norms as per the amendment in the Petroleum Explosives Safety Organization (PESO) Act and obtain clearances from the 'Competent Authority' for adding PCS to fuel filling stations.

1.2.6 Guidelines by Ministry of Road Transport and Highways for Promotion of EVs in India

In the Central Motor Vehicles (10th Amendment) Rules, 2018 for battery operated vehicles, the registration mark is to be exhibited in yellow color on green background for transport vehicles and for all other cases, in white color on green background²⁰. The amendment also proposes to exempt battery operated vehicles from renewal of registration certificate and assignment of new registration mark. This means that EVs would be exempted from such registration charges.

1.2.7 Proposals for availing incentives under FAME-II for deployment of EV charging infrastructure

The DHI came up with an EoI²¹ on August 28, 2019 for availing incentives under FAME-II for deployment of EV charging infrastructure in various cities. Initially 1,000 EV charging stations (slow and fast) were earmarked for deployment. These chargers are to be deployed in different states/cities/entities on the evaluation of proposal received by DHI. Categories of charging stations are mentioned in table 10.

Table 10: Various categories of charging stations introduced under FAME-II

Type of Charging Stations	Minimum number of charging guns	Min number of EVs to be charged at a single time	Types of chargers mandatory	Optional charger types
Slow Charging Stations	10	10	Bharat AC 001 10kW (3 guns of 3.3kW each)	Bharat DC 001(15kW) 1Gun; Type 2 AC charger
Fast Charging Stations	6	6	CCS II & CHAdeMO 50 kW or higher capacity	Bharat DC 001 (15 kW) 1 Gun; Type 2 AC 22kW or higher capacity

Under this expression of interest following categories of EV charging stations got the support:

Category A: Charging stations at public places for commercial purpose to charge (e.g., EV charging stations at Municipal Parking, Petrol Stations, Malls, Markets, Airport, Metro Stations, Bus

²⁰ <https://pib.gov.in/newsite/PrintRelease.aspx?relid=181837>

²¹ Department of Heavy Industry. Expression of Interest Inviting Proposals for availing incentives under FAME India scheme Phase II for deployment of EV charging infrastructure within cities. August 2019. Source: <https://dhi.nic.in/writereaddata/UploadFile/Revised-%20Expression%20of%20Interest.pdf>

Stops etc.). These charging stations can claim maximum demand incentive of 70% on the cost of EVSE from DHI FAME-II.

Category B: Charging Stations within the premises of state or central government office, government hospitals, government educational institutes (e.g., EV charging station established in Shram Shakti Bhawan, PSU Office Complex etc). 100% of incentive can be avail on the cost of EVSE from DHI under FAME-II.

Category C: Charging Stations established within the semi-restricted premises for commercial or non-commercial purpose for charging of EVs (e.g., charging stations established for Taxi Aggregators, Co-operative Housing Societies). They can avail 50% of the cost of EVSE from DHI under FAME-II.

The Department of Heavy Industry has recently sanctioned 2636 charging stations in 62 cities across 24 States/UTs after the acceptance of Expression of Interest under FAME-II. About 106 proposals from public/private entities for the deployment of about 7000 EV charging stations were received. Out of these, 2636 charging stations were approved by DHI of which 1633 will be Fast Charging Stations and 1003 will be slow charging stations. The sanction letters to the selected entities will be issued in phases after ensuring the availability of land for charging stations, signing of necessary agreements/MoU with concerned partner organizations like city municipal corporations, DISCOMs and oil companies. The allocations of EV charging stations are shown in figure 6.

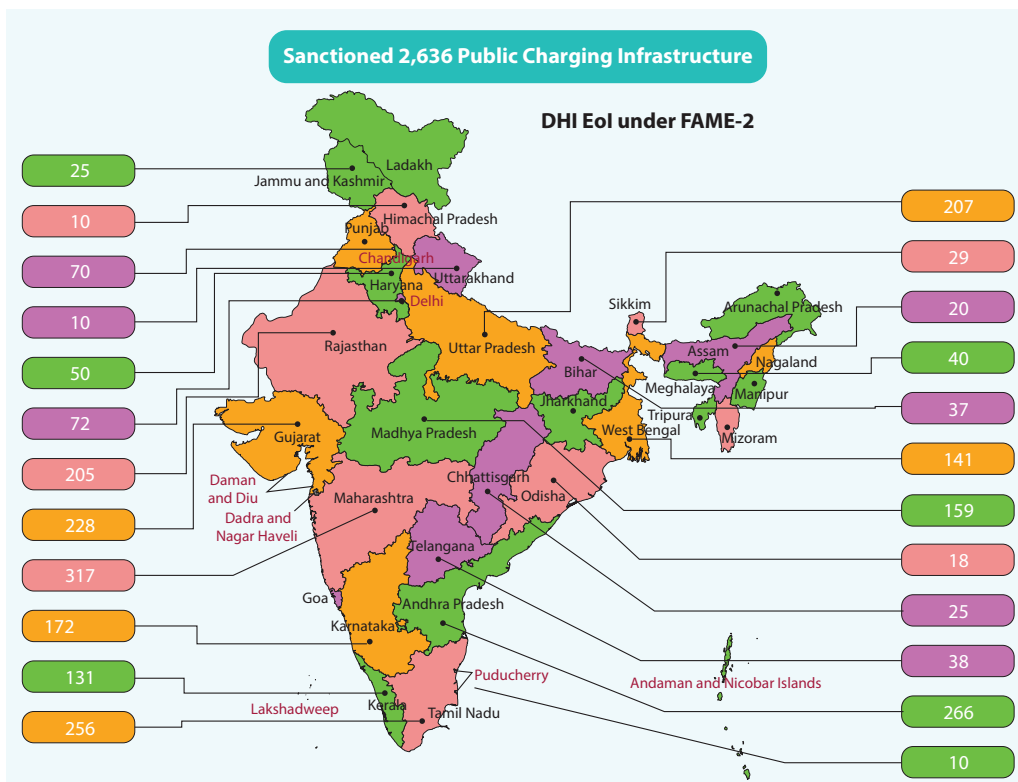

Figure 6: Allocation of EV Public Charging stations under the EoI issued by DHI (Source: TERI analysis based on data from current EoI from DHI)

1.2.8 Union Budget Envisions India as a Global Hub for Manufacturing Electric vehicles

The Union Budget 2019-20²² had outlined various proposals for giving a boost to manufacturing of electric vehicles and developing India as a global hub for the same. Government has lowered the GST on electric vehicles from 12% to 5%. The union budget is also providing additional income tax deduction of Rs. 1.5 Lakh for an individual on interest paid on loans taken to purchase electric vehicles. This amounts to a benefit of around Rs. 2.5 lakh over the loan period to the taxpayers who take loans to purchase electric vehicle. As a further incentive to e-mobility, customs duty was exempted on certain parts of electric vehicles.

1.3 Global EV Charging Standards and Protocols (AC and DC Chargers)

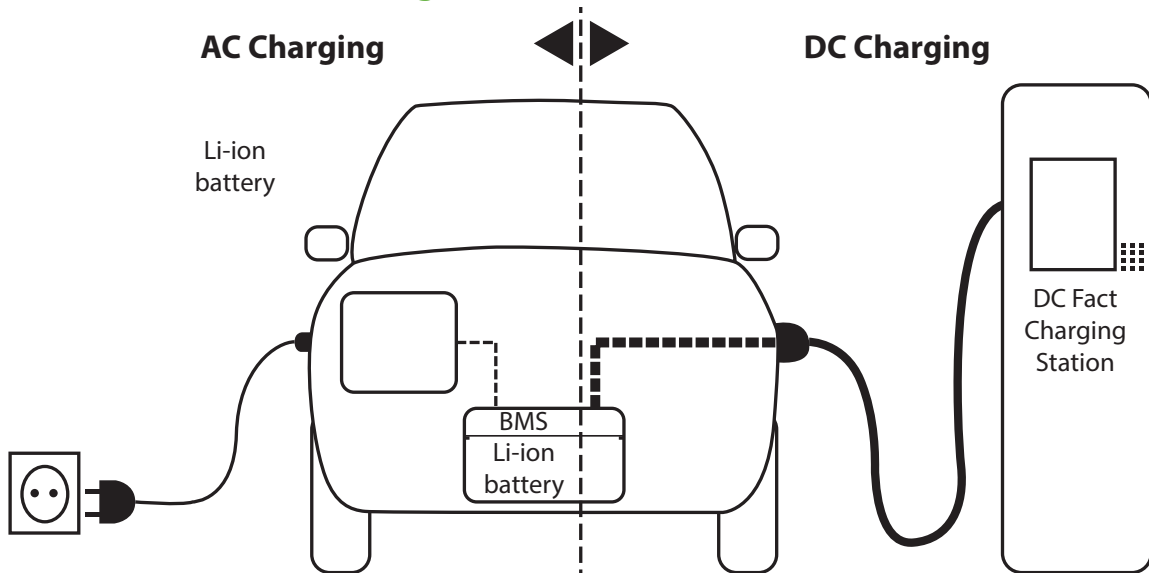

Figure 7: AC and DC Charging Techniques (Source: ABB)²³

AC and DC chargers come with different power ratings and accordingly are classified into Level-1, Level-2, and Level-3. These level definitions are different for AC and DC chargers as shown in table 11.

Table 11: Definitions for three levels of EV charging

Level	AC Chargers	DC Chargers
Level 1	120V single phase AC up to 1.9 kW (up to 16A)	200-450V DC up to 36 kW (up to 80A)
Level 2	240V single phase AC up to 19.2 kW (up to 80A)	200-450V DC up to 90 kW (up to 200A)
Level 3	Greater than 20 kW	200-600 V DC up to 240 kW (up to 400A)

²² "Union Budget 2019-20"; Source: <https://pib.gov.in/newsite/PrintRelease.aspx?relid=191292>

²³ ABB. Multi-standard DC fast charging stations. Source: <https://new.abb.com/ev-charging/products/car-charging/multi-standard>

Prominent Electric Vehicle charging standards

An overview of key charger characteristics is presented in table 12.

Table 12: Overview of EV charger characteristics in key regions across the globe²⁴

Characteristics	CCS	GB/T	CHAdEMO
Regions following the standards	Worldwide	China	Worldwide
Charging Standards	SAE J1722	GB/T20234	IEC 62196-4
Communication protocol between EV and EVSE	PLC	CAN	CAN
Type of charging	AC and DC	AC and DC	DC
Charging Limit	1000V, 350A, 350kW	750 V, 200A, 150kW	500V, 125A, 400kW

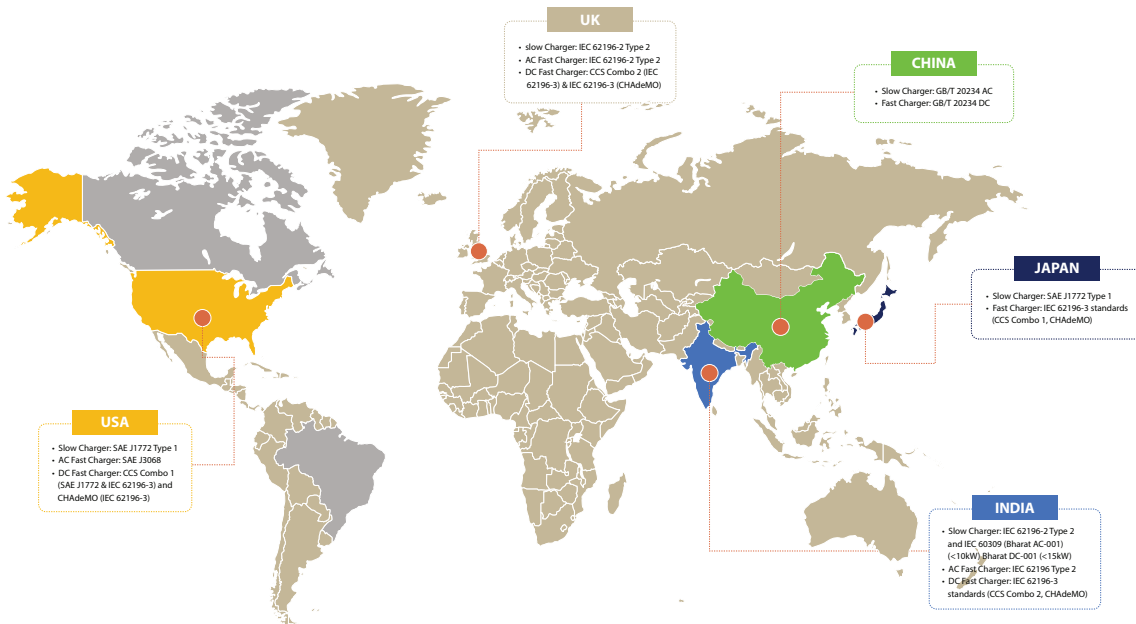

Figure 8: Global overview of EV charger characteristics in key regions

1.4 EV Policies and Regulatory Framework by State

Electric vehicles promise zero tailpipe emissions and a reduction in air pollution in cities. Government of India has created enough momentum through its FAME schemes which encourages, and in some segments, mandates adoption of EVs, with a stated goal of reaching 30% EV penetration by 2030. To scale the deployment of EVs, state government and local transport bodies collaborated with each other. As of February 2020, 14 States/UTs have published draft or final EV policies which are shown in figure 9. In addition, 20 States/UTs so far have issued tariff orders for EV charging (refer to Table 13)

²⁴ Ali Bahrami, "EV Charging Definitions, Modes, Levels, Communication Protocols and Applied Standards", Technical report. January 2020.

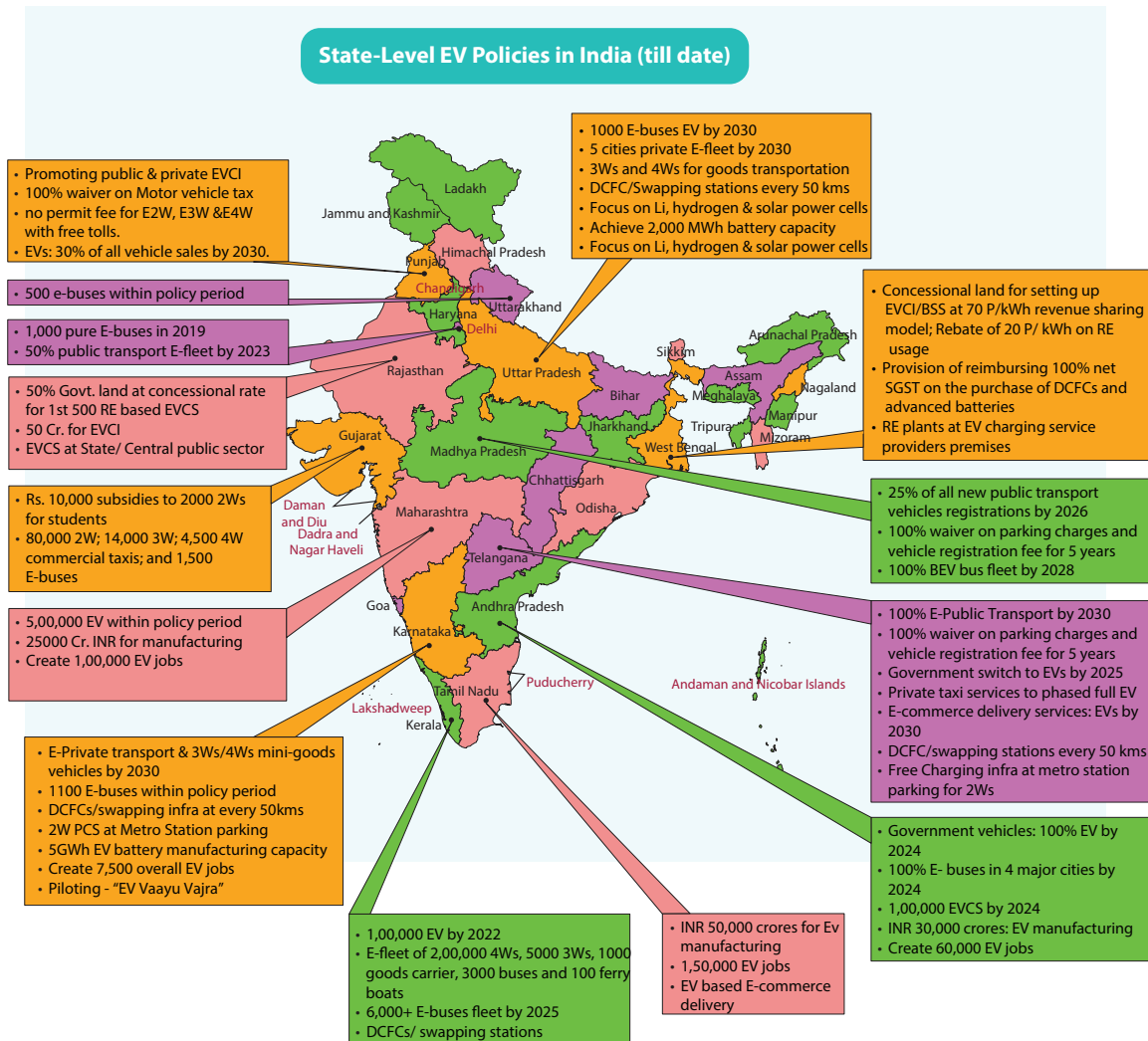

Figure 9: State Electric Vehicle policies at a glance

Note: Some states including Bihar are expected to come up with draft policies on electric vehicles soon.

1.4.1 State/Union Territories-specific EV Charging Tariffs at a Glance

Table 13: State/Union Territory-specific EV Charging Tariff at a Glance

S. No.	State	Energy Charges	Fixed Charges/Demand Charges	ToD Tariff
1.	Delhi	Supply at LT- Rs.4.5/kWh; Supply at HT- Rs.4/kVAh	No Demand Charges	May-September – Peak Hours: 14:00 Hrs-17:00Hrs and 22:00Hrs-01:00Hrs (Surcharge-20%), Off Peak Hours: 04:00 Hrs- 10:00Hrs (Rebate-20%)
2.	Himachal Pradesh	Contract Demand ≤ 20 kVA: Rs.5.00/kWh; Contract Demand >20 kVA: Rs.4.70kWh	Contract Demand ≤ 20 kVA Fixed Charges: Rs.130/ month Contract Demand >20 kVA : Demand Charge: Rs.140/kVA/month	N.A.
3.	Punjab	Rs. 6/kVAh	No Fixed Charges	N.A.
4.	Haryana	Rs.5.58/kVAh to Rs.6.2/kWh	Fixed Charges: Rs.100/ kW per month	N.A.
5.	Gujarat	Supply at LT- Rs.4.1/kWh; HT-Rs. 4/kWh	Demand Charge: Rs. 25 per kVA	N.A.
6.	Maharashtra	Rs.6/kWh	Fixed Charge: Rs.70/kVA/ Month	TOD/Surcharge/Rebate: 22:00 Hrs-06:00Hrs: Rs(-) 1.5/ kWh; 18:00 Hrs-22:00 Hrs: Rs.1.5/kWh
7.	Karnataka	Rs.5/kWh	Fixed Charge: LT- Rs.60/ kW/Month; HT- Rs.190/ kVA/Month	N.A.
8.	Andhra Pradesh	Rs.5/kWh	No fixed Charges	No TOD applicable
9.	Telangana	LT Rs.6/kWh, HT (11kV and above)- Rs.6/unit with TOD charges		06:00 AM to 10:00AM and 06:00PM to 10:00 PM (Rs.5/unit) 10:00PM to 06:00AM (Rs.7/unit)

S. No.	State	Energy Charges	Fixed Charges/Demand Charges	ToD Tariff
10.	Chhattisgarh	Rs.5/kWh	No Demand Charge	N.A.
11.	Jharkhand	Rural- Rs.5.25/kWh Urban- Rs.6.00/kWh	Fixed Charges: Rural- Rs60/Conn/Month Urban –Rs.225/Conn/Month	N.A.
12.	Madhya Pradesh	LT: Rs.6.00/kWh; HT Rs.5.90/kWh	Fixed Charges: LT-Rs.100/kVA; HT: Rs.120/KVA of Billing Demand	N.A.
13.	Uttar Pradesh	LMV: Rs.6.20/kWh; HV: Rs.5.90/kWh Public Charging: LT- Rs.7.7/kWh; HT- Rs.7.3/kWh	No Demand Charges	Summer Months: 05:00 hrs – 11:00 hrs- (-) 15%; 17:00 hrs – 23:00 hrs-(+) 15% Winter Months: 17:00 hrs – 23:00 hrs (+) 15%; 23:00 hrs – 05:00 hrs- (-) 15%
14.	Goa and other UTs	Rs.4/kWh	Fixed Charge: Rs.100/kW/month	N.A.
15.	Kerala	LT: Rs.5/kWh; HT: Rs.5/kWh	Fixed Charge LT: Rs.75/kW/month; HT: Rs.250/kVA/month	N.A.
16.	Orissa	Rs. 4.2 to 5.7/ kWh	No Demand Charge	N.A.
17.	Bihar	LT: Rs.6.5/kVAh; HT: Rs.6.5 to 6.65/kVAh	Fixed Charge: Rs.144/kVA/month (LTI) Rs.180kVA/month (LT II) Fixed Charge: Rs.300/kVA/month (HT)	N.A.
18.	West Bengal*	LT: Rs.4.5/kWh HT: Rs.4/kVAh	No Fixed Charges	*yet to confirm
19.	Rajasthan	LT: Rs.6.00/kWh HT: Rs.6.00/kVAh	LT: Rs.40/HP/month of sanctioned load HT: Rs.135/kVA/Month	Off Peak: 23:00hrs to 06:00hrs (-) 15%
20.	Assam	LT- Rs.7.6/kWh HT- Rs.6.9/kWh	LT: 120/kW/month HT: 160/kVA/month	N.A.

2. ANALYSIS OF EXISTING STUDIES ON EVs IN INDIA: MAJOR FINDINGS AND RECOMMENDATIONS

Chapter 1 provided an overview of the EV policy landscape in India including the major bodies involved, the fiscal policies in place and the strategies to electrify public transportation first. A glimpse of the global best-practices and how they contrast to that in India as of now was also provided. Lastly, the various charger technologies and charging standards followed globally and being adopted in India were discussed. It is extremely important to properly assess and analyze the impact of a particular technology and strategy of electrification on the distribution network where EV charging infrastructure (EVCI) is expected to come up.

To develop a sustainable electric mobility ecosystem, power utilities have a major role as they have to oversee successful development and deployment of EVCI within their license area. The increased demand for electricity from e-mobility makes a revenue earning opportunity for the utilities weighed against the additional investments required for up-gradation of the current infrastructure to supply power to the intermittent EV charging demand. Some of the utilities in India are leading in the initiatives for establishing EV ecosystem. They have launched different kinds of e-mobility programs by specifying a target number of charging stations to be installed, declaring financial provisions, and forging tie-ups with third parties to setup the EVCI including adopting innovative business models. It is thus crucial to study the challenges that the DISCOMs are going to face at various fronts. Many studies have been done by reputed national and international research organizations in this regard. This chapter summarizes the major findings of these studies.

2.1 Technical challenges for DISCOMs

When an electric vehicle is connected to the utility grid for charging, owing to its non-linear load characteristics, there could be power quality (PQ) issues such as harmonic distortions, voltage/frequency deviations, phase imbalance, and DC offset in the electricity distribution network of the DISCOMs. The most critical task for DISCOMs is to forecast the load growth including those from EVs or how much EV charging demand can be expected in future. The charging demand patterns or, user behavior is also un-predictable for DISCOMs. Consequently, there may be several challenges for DISCOMs when EV penetration increases.

2.1.1 Peak power increase/ charging demand patterns

Grid operation may be affected in a scenario of increased EV penetration due to uncontrolled charging. The simultaneous charging of multiple EVs, connected randomly and drawing rated power may cause phase imbalances, increase in peak demand, as well as power quality and harmonics related problems in distribution networks.

A recent study²⁵ presents the observations on impact of large-scale integration of EV charging infrastructure in the electricity distribution system. This document describes the results of a simulation study done for some feeders shortlisted based on existing EVCS in the feeder, Solar Photovoltaic (SPV) penetration, loading of feeder/DTs, consumer mix and priority for level 2 and fast charging for public charging stations. The findings from the report imply that implementation of ToU tariff will help manage the EV charging demand during high solar generation. It shows that the utility, herein BSES Yamuna Power Limited (BYPL), would require 1,517 Million Unit (MU) of additional energy for the EV penetration projected for the year 2030 and 12.3% peak demand consumption by the EVs in the year 2030 with reference to peak demand without EVs in the system. The load factor from EV charging closely matches with DISCOM's other loads and hence can be planned on 'as is where is' basis rather than requiring any drastic change or, investments.

Results presented in another report²⁶ show that the baseline 50% loaded commercial feeders (studied in the report) could handle the EV charging load up to an additional 20% using fast charging. The report used MATLAB/ Simulink modeling and simulation platform to analyze the impact of EV charging on different feeder systems. The report recommends peak time charging scenario loading up to additional 20% of EV load using fast charging as the threshold. The important takeaway was that the utilities/DISCOMs should build resilience by network expansion for higher loading and the impact of slow chargers on these feeders was found to be negligible.

Generally, power procurement is a challenge in India during peak hours as the demand varies over the day. As per the CEA, the all India plant load factor (PLF) was only 61.015% upto February 2019. Charging the EVs during off peak hours has a potential to increase PLF of thermal power stations and also mitigate their ramping up/down requirements. Surplus electricity generated during lower demand period can be used for EV charging²⁷.

A study²⁸ carried-out by IIT Kanpur looks at the impact of EVs on the power distribution system considering the existing electrical load curve of a typical summer day (peak day) with load growth for 2025 & 2030 and EV growth rate (considering charging behavior) forecast. The study shows that the impact on the distribution system will be in the form of overloading of DTs, increased power losses, instability of grid, voltage fluctuations, and lower power quality, etc. This study considered the following four cases for different cities:

- Case 1:** 90% of total Non-commercial 4-wheelers EVs charged at home and rest 10% are charging at charging station,
- Case 2:** In this case, 70% of total Non-commercial 4-wheelers EVs charged at home and rest 30% are charging at public charging station,
- Case 3:** In this case, 50% of total Non-commercial 4-wheelers EVs charged at home and rest 50% are charging at public charging station,
- Case 4:** In this case, all non-commercial 4-wheelers EVs charged at public charging station.

Figure10: shows percentage changes in peak demand in the four cases due to EV charging.

²⁵ C.R. Atla, S. Muhiuddeen, S. Narayana, Hemanth M., R. Bagdia, S. Mishra, J. Gaebler, I. Mitra and D. Sharma, "Impact assessment of large-scale integration of Electric Vehicle charging infrastructure in the electricity distribution system", 2nd International Conference on Large-Scale Integration of Renewable Energy in India, New Delhi, September 2019.

²⁶ Forum of Regulators. Study on Impact of Electric Vehicles on the Grid. Technical Report. September 2017.

²⁷ IIT Madras and WRI India. A Guidance Document on Accelerating Electric Mobility in India.

²⁸ Prof. Ankush Sharma, Aastha Kapoor and Prof. Saikat Chakrabarti, "Impact of Plug-in Electric Vehicles on Power Distribution System of Major Cities of India: A Case Study", IIT Kanpur report, August 2019.

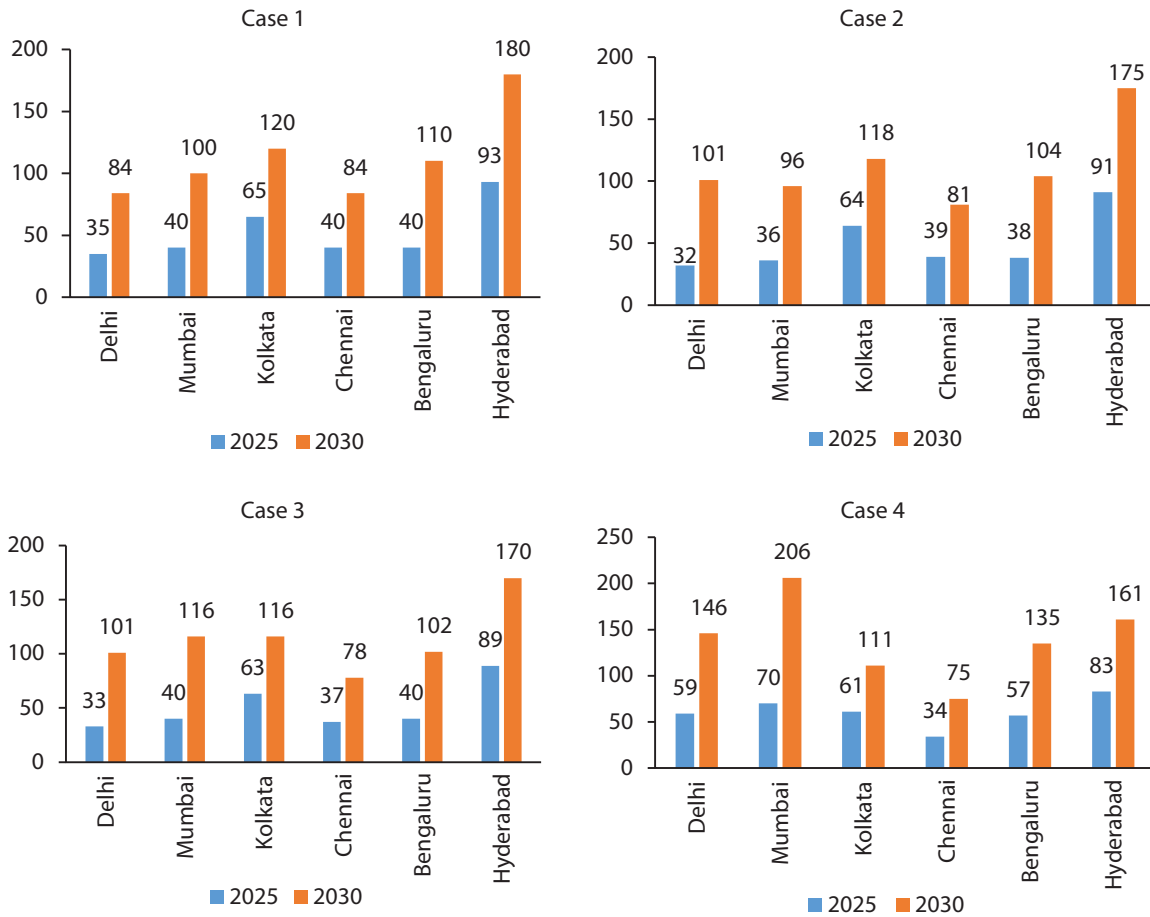

Figure 10: Percentage changes in peak-demand due to EV charging

The results show that the peak demand increases by 30-90% in different cities in year 2025 and up to 200% in 2030. The peak time also shifts from day peak to night peak.

The study²⁹ performed by Ernst & Young & the BEE recommended planning for EV charging infrastructure considering key parameters like EV adoption numbers, battery sizing for different vehicle segments, charging behavior, and peak load etc. With assumed EV stock and battery sizes, estimated Lithium ion battery (LIB) capacities to be required to support the distribution systems in Delhi, Lucknow & Nagpur will be 48.5 GWh, 13.7 GWh & 3.7 GWh respectively by the year 2030 with both integrated & swappable options for EVs. As the projected 8169 MUs/year of electricity consumption is likely to take place due to EV charging alone in 2030 in Delhi, DISCOMs need special planning and interventions for grid augmentation. The estimated average and peak load from EV charging is presented in table 14.

²⁹ Bureau of Energy Efficiency and Ernst & Young. Propelling Electric Vehicles in India: Technical study of Electric Vehicles and Charging Infrastructure. Technical report. 2019.

Table14: Average & Peak EV charging load to grid³⁰

Year	Delhi		Lucknow		Nagpur	
	Avg. load from EVs(MVA)	Peak load from EVs (MVA)	Avg. load from EVs (MVA)	Peak load from EVs (MVA)	Avg. load from EVs (MVA)	Peak load from EVs (MVA)
2020	346	72	224	62	44	13
2025	4321	878	1707	486	467	134
2030	15901	3024	6000	1755	1600	468
CAGR	47%	45.2%	39%	40%	43%	43%

2.1.2 Power quality related issues

EV charging uses power electronics-based devices to convert AC to DC power. The high-frequency pulse-based switching in the conversion process can cause distortions in the system voltage and current. These harmonics can influence the distribution assets of the DISCOMs that reduce the life span and in case of protection equipment there may be false tripping. Among the most affected distribution assets are transformers, power cables, relays, switchgears, capacitors and metering equipment.

For assessing the power quality impacts more deeply, a measurement study³¹ was conducted by GIZ/PRDC for BSES Yamuna Power Limited (BYPL), a DISCOM serving Eastern and North-Eastern Delhi, considering different scenarios. In the first scenario, harmonic injections from EV charging points were considered while in the second scenario, harmonic injections from both EV charging points and those from inverters of solar rooftop solar plants were considered and evaluated as per the limits provided in IEEE standard to find out the maximum impact of EV charging on the grid. They concluded that about 50% of transformer loss of life is caused by thermal stress produced by the nonlinear load. The simulation results show that the effect of current harmonics on transformer life is very high and when the harmonic distortion level is more than 7.5%, the life of DTs will start deteriorating exponentially.

In the study³² published by the Ola Mobility Institute on the Ola EV pilot in Nagpur, voltage fluctuation challenges were faced at charging stations. Due to these voltage fluctuations, fast chargers at charging stations became non-functional once every 40 days. When EVs increase in the city then these types of problems are expected to increase. Thus, there is a need for improvement in transmission & distribution infrastructure and management as well as to integrate energy storage systems at charging stations. Grid conditions need to be upgraded for better and efficient charging of EVs at EVCS.

2.1.3 Integration issues of EVCI into the grid

³⁰ Ibid

³¹ Ibid 23

³² Nitish Arora and Aishwarya Raman, "Beyond Nagpur: The Promise of Electric Mobility - Lessons from India's first Multi-Model E-mobility Project"; OLA Mobility Institute report, 2019.

Effective deployment of EVCI based on a sustainable operating model is necessary for accelerating adoption of EVs. At present, low volume of EVs on the road results in lower asset utilization of EVSE at charging stations. Due to rapid technological transitions in EVs and battery-related standards of EVSE, it seems risky from the investor’s end to deploy EVCI due to less utilization of their asset at present.

Charging infrastructure is the most crucial enabler in the entire EV value chain. The limited availability of EVCI, including a lack of adequate business and financial models, is one of the biggest challenges to adoption of EVs by customers, who still suffer from ‘range anxiety’. In fact, challenges to adopting e-mobility are akin to dealing with the classic chicken and egg problem: what should come first – EVCS/ swapping stations or EVs.

In different reports^{33,34,35}, the findings suggested that DISCOMs should utilize their land housing substation/offices to set up the EVCI either by self-investment or by partnership with private or third-party operators. In many places, it would be strategically advantageous to locate EV charging stations next to an existing fuel pump, particularly on highways. However, in regard to setting up EVCS at retail fuel outlets, installing an EVCS at the high voltage level (11 kV and above) inside or next to a petrol pump requires special approval under the Indian Explosives Act, 1884.

As per the study done by Ola Mobility Institute³⁶, high electricity tariffs coupled with limited fleet size led to under-utilized charging infrastructure. The average utilization rates were 40% and 5% for fast and slow chargers respectively. Land lease rental coupled with electricity expenses constituted over 62% of total operating costs, adversely affecting economic viability of the project and discouraging scaling up of operations.

A model was developed in a study³⁷ conducted by Ernst & Young researchers on viability assessment of setting up of charging stations. Table 15 presents the deployment model for setting up of DC fast charging stations at public parking spaces. Key findings from three cases are mentioned in table 16 for viability assessment of DC fast charging stations.

Table 15: Model for setting up DC fast chargers at Public parking spaces

Deployment model for a DC fast charging station at a public parking space	<ul style="list-style-type: none"> a. Municipal corporation can give parking lot space to CPO or an operator on lease b. CPO or operator will charge a fixed minimum cost for parking of vehicles c. Operator pays to DISCOM in INR per kWh basis as per EV tariff category d. Blended price per min basis of charging= losses in EVSE+ charger capital cost+ one-time installation cost+ O&M cost charged to EV user
---	---

³³ P.C. Bhagwat, S.Y. Hadush and S.R.K. Bhagwat, “Charging up India’s Electric Vehicles: Infrastructure deployment & power system integration”, Report by European University Institute, Robert Schuman Centre for Advanced Studies and the Florence School of Regulation, 2019.

Table 16: Viability assessment for setting up DC fast charging station

³⁴ Ibid 23

³⁵ Ibid 27

³⁶ Ibid 30

³⁷ Ibid 27

Scenarios	Observations
Case 1: Capital subsidy provided	<ul style="list-style-type: none"> ❖ Project is viable, NPV is greater than zero when capital subsidy is more than 45% and equity IRR is 30.2% which is greater than WACC, ❖ With higher utilization of EVSE, lower retail per min pricing determined to be INR 4 per min that the CPO is likely to charge the EV user with considering charging station utilized 6 hours a day and shall operate 330 days in a year. ❖ Cost of operation of EV has to be determined to be INR 1.54 per km, for equivalent diesel and CNG it was found to be INR4.20 and INR1.85 per km respectively. ❖ If tariff charged by DISCOMs to the CPO exceeds INR 8.5 per kWh then those EVs lose the advantages of lower operational costs.
Case 2: No capital subsidy provided	<ul style="list-style-type: none"> ❖ The project is viable, NPV is greater than zero when mark up on electricity is more than 3% and equity IRR is 14.5%, which is greater than WACC. ❖ The retail pricing is determined to be INR 4.13 per min that the CPO is likely to charge the EV user with considering charging station utilized 6 hours a day and shall operate for 330 days in a year, ❖ Cost of operation of EV has been determined to be INR1.61 per km, for equivalent diesel and CNG vehicle same was found to be INR 4.20 and INR 1.85 per km respectively. ❖ If tariff charged by DISCOMs to the CPO exceeds INR 9 per kWh then EVs lose the advantages of lower operational costs.
Case 3: CPO get into PPP model	<ul style="list-style-type: none"> ❖ Land opportunity cost for Municipal Corporation considering monthly rental of INR20,000 with an annual escalation of 10%. Even after a 10% revenue sharing arrangement with private entity, the public entity cannot recover this cost. ❖ Public entities with underutilized land (having a low opportunity cost) will be more suitable for this model. For e.g. distribution companies might utilize their land near existing substations for setting up charging stations which might also require collaboration with the municipality to get clearances to allow vehicles to park and charge. ❖ Assuming no capital subsidy is provided, the charging station operator has to charge a minimum of 13% as the mark-up on cost of electricity tariff as retail price for ensuring project viability.

2.1.4 Recommendations from the Reports/ Studies

Increased load due to EV charging can be controlled by implementing demand side management and ToD/ToU tariff structure was one of the prime findings in these studies. To facilitate smooth grid operations, large EV charging stations or aggregators should communicate with DISCOM control centers and provide

them their future charging demand of EVs. This was also among the major operational-level suggestions.

Summing up, the major recommendations made in different reports are given below:

- ❖ Load shifting by using the ToU/ToD tariff mechanism to shift the EV charging demand from peak to off peak period can be done to decrease the loading of distribution asset during peak hours.
- ❖ Component overload can be reduced by network reinforcement by increasing the load ratings of those that are likely to be overloaded due to increased EV charging demand.
- ❖ Regulators should allow DISCOMs to set up public charging infrastructure within their license areas and there should be 100% capital subsidy for EVCI set up under FAME-2.
- ❖ If there is any private CPO or electric fleet operator who wants to invest in setting up EVCI by using DISCOM land having easy and reliable electricity connection access that can be a good partnership for DISCOMs to sell the electricity.
- ❖ Harmonic filters are recommended under the conditions when current and voltage harmonics are recorded to exceed the limits as specified in IEEE 519 during high levels of EV and rooftop solar penetration.
- ❖ EV charging stations should be designed with RE generation or allow power banking/net metering to shifting towards clean energy.
- ❖ Battery swapping stations should be encouraged to charge the EVs during off-peak periods of the grid or should be covered under ToD/ToU pricing to manage the peak.
- ❖ There should be a separate provision for financial approval in case the utility requires upgrading or augmenting its grid infrastructure.
- ❖ Intelligent charging stations having facilities like fast/slow charger with timers and that are able to switch from normal charging mode to another mode based on the real time grid parameters must be piloted to encourage smart charging.
- ❖ Standardization is required for EVs, EVSEs and connectors between EVs and EVSEs including communication protocols. The EVCS must have provisions for providing a reliable safety protection system to detect various faults/ abnormal conditions and provide appropriate means to isolate the faulty part or system automatically. They should also ensure that any fault in the equipment or system does not affect the grid adversely.
- ❖ Regarding to power quality standards, the user has limit of injection of current harmonics at point of common coupling (PCC) and it shall be in accordance with the IEEE 59-2014 standards, as amended from time to time. The prosumers shall not inject DC current greater than 0.5% of the rated output at PCC and 11kV or above connectivity.
- ❖ Uncontrolled charging of EVs could increase the peak demand on the grid, contributing to overloading of distribution transformers and necessitating a need for infrastructure augmentation at the distribution level. EV charging demand could be managed by smart charging using vehicle-grid integration (VGI) technologies. Concept of smart charging includes ToU pricing without automated control, dynamic pricing with automated control, unidirectional controlled charging(V1G) and bi-directional controlled charging (V2G, V2B, V2H) where G,B and H stand for grid, building and home

respectively. These can be implemented either by customers responding to price signals as ToD/ToU/ dynamic pricing or dictated by customers' needs for vehicle availability.

- ❖ Smartly charged/discharged EVs could help in reducing the curtailment of variable renewable energy (VRE) and in improving local consumption of VRE production and also avoid investment in peaking generation capacity and flatten the load curve to better integrate VRE into the grid. This can also provide bigger benefits to the system having high solar PV than wind, because of the more predictable generation profile from solar PV plants.
- ❖ EVs being charged by slow chargers can better support in providing grid-stability and reliability through V2G mode since these EVs are parked for a long time and remain connected to the grid through EVSEs. Fast chargers are only connected for very short duration and could support the grid only minimally.
- ❖ There should be standard guidelines and single-window clearance for approvals from municipal departments, city planning offices and other statutory bodies for construction and operation of charging stations and swapping stations. This needs to be augmented with fast track approvals for sanctioning of electricity load, design and building plan, fire and safety approval. Currently, this process takes around 90-120 days, which should be done within 7-14 days for faster operationalization and mass adoption of EVs.

2.2 Regulatory challenges for DISCOMs

2.2.1 Tariff structure for DISCOMs

The regulator may define the pricing mechanism for EV charging for DISCOMs as well as for charging stations owners. EV charging should be considered as a separate consumer category while specifying applicable tariffs like time of day (ToD)/ time of use (ToU) tariffs/ dynamic pricing or real time pricing. There are two types of pricing mechanisms for charge point operators: pass through and custom pricing.

In a pass-through pricing mechanism, the charge point operator (CPO)/aggregator, passes the ToU/ToD tariff to the EV customers including a certain amount of rate added above the ToU rate and revised based on charging utilization to ensure not to overcharge customers. In the custom pricing mechanism, the CPO or aggregator creates a customized pricing structure for EV owners for example rates of some amount per unit, flat fee pricing or free charging.

There will be significant impact on tariff due to investment in public charging infrastructure by the DISCOMs as found in a study report³⁸ that considered two different scenarios for impact on tariff due to distribution licensee's investment. The impact of investment was considered in two formats: full investment socialized to all the consumers of the licensee and in the second scenario, investment is charged only to the EV category using the low and high EVCI growth rates. An impact of Rs. 0.1970/kWh and Rs. 0.0040/kWh on tariff was found when investment was charged only to EV users and the same socialized to all the consumers respectively while considering the aggressive NEMMP/ FAME-II targets.

2.2.2 Recommendations from Reports studied/analyzed

The subsequent paragraphs summarize the major recommendations provided by the reports studied

³⁸ Ibid 24

and analyzed, in view of the regulatory issues pertaining to EV charging infrastructure for the distribution companies.

Regulators should allow distribution licensees/DISCOMs to appoint multiple & non-exclusive franchisees to set up public EVCI within their license area and there should be a simplified framework for franchisee agreements between these two for setting up EVCI. To utilize the DISCOM's assets during low electricity demand, special ToD tariff for EV charging for use of low utilizing DTs/feeders should be allowed.

EV charging tariff can be leveraged for commercial usage or can be misused by tampering meters. Tariff for EV charging may be viewed from a different perspective. The EV batteries can act as Distributed Energy Resources (DERs) to provide voltage/frequency support to the grid. ToD/ToU tariff for EV charging could promote EV rollout and help to improve the load factor for the power system. However, for implementing ToU tariff, there is a need for up-gradation of metering system and billing mechanism. Whenever EV charging/discharging takes place, the process should use proper customer identification & authorization with proper standardization. The billing mechanism should have a flexible pricing mechanism that includes real-time and prepaid options so that the EV users can get the benefit of ToD tariffs. Also, locations, capacities and availability of all charging stations in the city should be available to EV drivers including real time status of charging, reservation of charging slot, up-time/ breakdown status of charging infrastructure etc. This can be made available through suitable mobile phone applications.

Regulators can accelerate the EV adoption in India by specifying tariffs that are suited best for both DISCOMs and EV owners. Salient recommendations from some of the study reports^{39, 40, 41, 42, 43} regarding rational tariff for e-mobility in India are as under:

- ❖ Additional fixed/demand charges coming from EVs for all type of connection categories should be zero or could be time bound for a certain period and after evaluation, it can be extended further.
- ❖ Home and office/work charging could be allowed to move to three phase connection under ToD tariff or kept under same tariff category, as applicable.
- ❖ Allow the EVCI aggregators to purchase power from open access without any limit (currently 1MW) without cross subsidy surcharge and allow power banking/net metering of RE based generation to promote reduced tariffs for EV charging.
- ❖ Encourage EV penetration by different kinds of tariff structure for residential, commercial and public charging stations. Until the EV penetration reaches to 10% of total vehicles in India or till 2021-22, energy-based tariff (or subsidized) should be there for residential users. For commercial category there might be two-part tariff (capacity and energy-based tariff) which will be helpful to encourage EV users. Similarly, for charging stations, introducing ToD with two-part tariff structure to minimize

³⁹ Akshay Ahuja, Bindeshwary Rai, Girish Ghatikar, Ravi Seethapathy, Reena Suri and Reji Pillai, "Implementation Plan for Electrification of Public Transportation in Kolkata", ISGF technical report, 2017.

⁴⁰ Reji Kumar Pillai, Reena Suri, Shreekant Dhuri and Suddhasatta Kundu, "Electric Vehicle Policies and Electricity Tariff for EV Charging in India", ISGF study report, July 2019.

⁴¹ National Smart Grid Mission-PMU. Electric Vehicles in India and its Impact on Grid.

⁴² Ibid 30

⁴³ Ibid 23

the impact of EV charging stations on the grid should be explored.

- ❖ The Forum of regulators (FoR) could be requested to make model regulations to provide the third party to set up EV charging stations, buy electricity from DISCOMs, and sell to EV owners at EV tariff decided by respective SERCs.

2.3 Financial/ Business Models

EVs are particularly suited to different kinds of vehicle segments and use cases, for example passenger fleets or commercial operations. There is an opportunity to build different business models for these EV use-cases of different segments using plug-in charging as well as battery swapping options. The most adopted business models in different countries have been utility-centric. The role of the utility varies depending on the power market structures. In a region having a regulated market structure, utilities are bound to set up EVCI and for billing the EV owners and the investment is recovered through tariff applicable for the EVCI. In case of an unregulated power market, utilities charge the CPOs for supplying electricity and CPOs are free to select the utilities for power procurement and pricing for EV charging.

2.3.1 Business Models

Different business models considered in different studies have looked at various entities that can take part in the business of EV charging. Figure 11 shows some of the business models adopted in different countries. Some of the business models from the distribution utilities perspectives are listed below: -

Distribution licensee owned EV charging infrastructure

- ❖ Distribution licensee will have the responsibility to provide the electricity to the EV owner.
- ❖ The retail supply tariff for supplying the electricity to the vehicle owners will be decided by the SERC of that respective state regulatory.

Distribution licensee franchised EV charging infrastructure

- ❖ If the utility does not want to invest in charging infrastructure due to funding constraints then it can authorize a third party to install and operate charging stations within its license area after suitable locational planning. The third party and utility can also enter into a public private partnership (PPP).
- ❖ The charging stations can receive electricity at a single point of delivery as bulk power or could purchase power from open access if allowed.

Privately owned battery-swapping stations

- ❖ Utility with its franchisee or third party can aggregate the demand for batteries and set up battery swapping stations.
- ❖ The third party can set up battery swapping stations with prior intimation to the utility to avail the special category tariff since a swapping station does not resell the electricity.
- ❖ The swapping station can receive electricity at a single point as bulk power from the utility or also can buy from open access to charge their batteries as per the provisions of the Electricity Act, 2003.

A battery swapping business model has been presented in a report⁴⁴ wherein an Energy operator (EO) invests in the cost of batteries and infrastructure cost at site (building, air-conditioning, electrical connection, IT and safety equipment) and operational costs for battery swapping station at petrol stations. The result shows that that the running costs of 4W and 3W categories are Rs. 2.08 per km and Rs. 1.32 per km respectively which is less than those for the ICE or CNG vehicles. However, for the e-buses, battery swapping is still costlier, Rs.18.85/km higher than the ICE vehicle, and this is because of the higher cost of investment in battery, swapping station infrastructure etc. given the size and running kms each day.

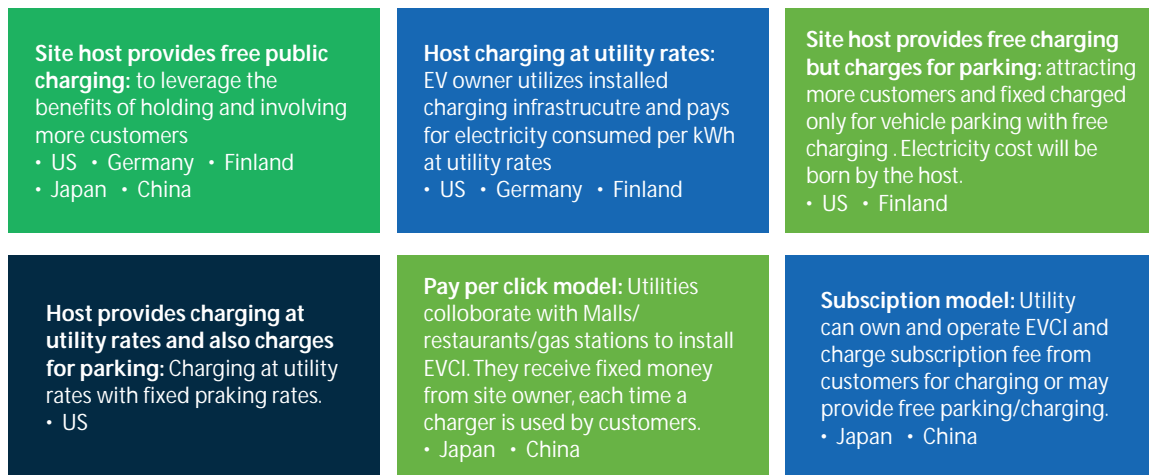

Figure 11: Business models adopted in different countries

2.3.2 Recommendations

This sub-section summarizes some of the recommendations on scaling-up deployment of EVCI in India that were made in the studies reviewed. Some of the findings translated into a few recommendations that are noteworthy in view of the business models for utilities to install, operate and maintain EVCI. The Nagpur pilot by Ola has shown battery swapping as a reliable charging mechanism for small vehicles (2W, 3W). Battery swapping is doable, efficient, and in the case of Nagpur, was pretty much successful. Battery swapping can also help in mitigating long waiting time of drivers at charging stations. Integration with renewable energy brings out dual benefits of not only achieving financial viability but also greening the entire EV usage cycle to a large extent. Installing rooftop solar plants at charging stations in Nagpur reduced the average electricity expense by 28%.

For a successful transition to electric mobility, there is a need for a multi-pronged strategy. Based on the review of literature, a set of actions emerged which can be followed in a synchronized manner so as to establish a comprehensive E-mobility eco-system considering every stakeholder. The set of actions, shown in figure 12, have been elaborated thereafter:

⁴⁴ Ibid 25



Figure 12: Crucial factors supporting transition towards e-mobility

Formulation of policies and regulations: Most of the stakeholders do not want to shift to e-mobility because of the need to make additional large investment that is currently not justifiable from a pure business perspective. Accordingly, some favourable policy & regulatory actions that can be taken up are:

- a. Tax incentives for novel/emerging technologies in this space and boost for manufacturing of EVs and EV components
- b. Mandating increased share of EVs in the domestic market by encouraging OEMs
- c. Increased investments in R&D on EVs and battery technologies

Establishing standards: There is a need for standardization of products and components to increase the acceptability of products across the segment of consumers, manufacturers and regulators. Standardization of the products increases the reliability and ensures trust among consumers.

Demand creation: The automobile manufacturing industry will have to make significant investments to change the vehicle product base in moving from the ICE based fleet to EVs. However, the industry will not be willing to do so unless there is some pressing need or compulsion or a visible demand. It will be necessary for the government to take initiatives in creating an initial demand for EVs so that the auto industry can see some commercial value in making the investment to manufacture EVs.

Financing: Availability of accessible financing arrangements is very important for the EV industry to grow. There could be innovative business models that can achieve the objectives of revenue realization and leasing of fleets is one of the fairly simple models to begin with. Vehicle OEMs could lease the EVs instead of selling them. There could be a leasing fee that is equivalent to the savings in operating costs and the loan repayment instalment on these vehicles.

Robust institutional arrangements: One of the biggest challenges in transitioning towards electric mobility is to develop an institutional mechanism that is able to facilitate the needed coordination and is robust and empowered enough to perform these actions swiftly. It has also been recognized that the academic institutions, research institutes, manufacturers, think tanks and civil society will be required to play a critical role in the successful transition to electric mobility as equal and important stakeholders.

Setting up of EVCI: Accelerated deployment of an initial network of charging stations, in the form of public charging stations at retail fuel outlets, at strategic traffic junctions or even as battery swapping stations is required so that it encourages the purchase of EVs and adds to the demand for charging. It will be an area where public investment will be required to initiate the EV adoption cycle, even if starting from public fleets.

Awareness campaigns and workforce skill development: Lack of awareness is a big problem further fuelled by high investment cost and uncertain benefits. Awareness campaigns must inform people about the larger societal benefits of EVs and the savings in operating costs. The skills of the workforce will need to be suitably aligned to ensure a steady and reliable supply and value chain. These jobs exist in manufacturing the parts of electric vehicles, their maintenance and after sales, and as services provided by drivers, operators and technicians.

2.4 Research Gaps

These studies covered various segments related to EVs such as global policies, charging infrastructure, business models for setting up of charging/swapping station, impact on distribution network etc. The areas which have not been comprehensively covered in these studies can be summarized as below:

- ❖ Power quality issues due to EV charging
- ❖ Growth rate of EVs considering charging behaviours
- ❖ Business models in the Indian context
- ❖ Only a few business models were discussed and that too related to DISCOMs in specific
- ❖ Forecasting of cost of EV components
- ❖ Cost-Benefit Analysis for fast-charging stations/ EVCS at fuel pumps/highways at different utilization levels
- ❖ Impact of harmonics due to EV on distribution assets (transmission lines, transformer, feeder etc.)

This report attempts to address some of these areas that have been covered in respective chapters. For instance, power quality issues due to EV charging, harmonics in particular, have been covered comprehensively in chapter 4 wherein actual site measurements have also been reported. Business models for EVCI installation, operation and maintenance for revenue realization have been discussed in chapter 3. These are on the basis of stakeholder interactions with DISCOMs, OMCs and cab aggregators/ fleet operators and reflect stakeholder-specific opinion. Annexure 4 presents a cost-benefit analysis for setting up a solar-powered bus charging facility at a bus depot. Usage of both fast-charging and slow-charging facilities and the relative benefits of using a ToD tariff alongside rooftop solar power were examined.

3. SUMMARY OF INTERACTIONS WITH DISCOMS AND OTHER KEY STAKEHOLDERS

This chapter summarizes the key findings that emerged from stakeholder interactions carried out as a part of the study. The EV ecosystem in India involves a lot of entities, other than the DISCOMs, who have a role to play in facilitating, implementing, administering and managing the EV charging infrastructure. Accordingly, relevant stakeholders like vehicle Original Equipment Manufacturers (OEMs), Central Government ministries and nodal agencies, Cab aggregators and fleet operators, Oil-Marketing Companies (OMCs) and Charge-point Operators (CPOs) were also interacted with.

A total of 13 DISCOMs spread across – Northern, Central, Eastern, Western and Southern regions were selected for consultation. These included both public and privately-owned DISCOMs. The availability of an EV policy in the state and/or notification of EV charging tariffs and the active level of participation in the implementation program including the initiatives taken so far were the major criteria for selection of DISCOMs. The project team met and interacted with a cross-section of mid-to-senior level DISCOM officials which included MDs, Directors, Chief Engineers, General Managers and Superintending Engineers – in-charge of commercial, technical, revenue and project implementation functions (EVs, new technologies). Face-to-face meetings and discussions and telephonic - group and individual interactions were held between December 2019 and February 2020. Similarly, interactions were held with the senior officials of relevant ministries, OMCs and OEMs and executives of fleet operators as well as charge-point operators. The list of various stakeholders interacted with is provided in Annexure 1.

The perspectives of various stakeholders were solicited on three aspects of EV charging infrastructure implementation- technical, financial/investment-related and regulatory. Apart from DISCOMs who responded to questions on all the three aspects, other stakeholders identified themselves with the aspect most relevant for them, or any additional one, and responded accordingly. The next sections provide the key points of the discussions held with DISCOMs and other stakeholders, arranged separately. The questionnaires for both the stakeholders are provided in Annexure 2 and Annexure 3 respectively.

3.1 DISCOMs' Perspective

The major themes addressed in the questions related to the technical, financial and regulatory aspects of EV charging infrastructure development and DISCOMs' responses to the queries is summarized below under respective heads.

3.1.1 Technical/Operational Aspects

The increase in EV penetration could lead to certain technical/ operational challenges in managing the increase in load. This section highlights the DISCOM's perspective on the anticipated issues and their suggestions on how the same could be addressed.

(a) Identification of suitable nodes for Electric Vehicle Charging Station (EVCS)

Locational planning of EVCS is important in identifying suitable points of connection in the distribution network. The parameters that need to be considered in identifying the same are traffic pattern, availability of space as well as network congestion in certain sections within the existing electricity distribution network.

Most utility representatives agreed that locational planning studies should also consider network congestion so as to ensure that the existing distribution infrastructure is better utilized. Many utilities are carrying out feasibility studies pertaining to setting-up of public EVCSs. Some of the utility representatives stated that their current network infrastructure can easily handle the increase in load due to EVs in the near future and considering network congestion issues in locational planning of EVCSs may not be necessary at the moment. Availability of space, permission from concerned government bodies/agencies and utilization rates of EVCS are also important to identify such locations.

(b) Importance of communication infrastructure and grid interactive EV Charging Infrastructure (EVCI) through Smart Energy Meters/ AMI

Smart Meters are essential for implementing grid interactive EV Charging Infrastructure (EVCI) which will help utilities to manage the increase in peak power requirement through various demand response measures better. This sub-section highlights the DISCOMs' perspective on the importance of the same.

As it emerged from the interactions, all DISCOMs representatives agreed that smart metering or AMI will be necessary to implement dynamic ToD tariffs/ Real-Time pricing while enabling the DISCOMs to remotely monitor, control and implement controlled and coordinated charging of EVs. This was also felt important to ensure efficient and automated distribution system operation.

Many representatives shared the concern that utilities may be unable to solely bear the entire cost of installation & commissioning of equipment required to set up this infrastructure.

(c) Connection agreements/ connectivity regulations for providing connectivity to home charging, or a public charging station

Separate connection agreements/connectivity regulations should be mandatory for setting up both public as well as residential EVCSs to ensure compliance with various safety and interconnection standards. Besides separate connection agreements, separate meters for EVCSs would help implement different tariff structures for EVs. This sub-section highlights DISCOMs' perspective on the importance of the same.

Half of the utility representatives interacted with agreed that separate connection agreements are essential for home-based charging, while some were of the opinion that the same should be necessary only for public EVCSs and the sanctioned load for residential customers with EVCSs would have to be increased. It was also acknowledged that the MoP guidelines of 1st October, 2019 clarifying domestic rates for home-based charging and special/subsidized rates for commercial charging supported charging station installation at residences. A few of the DISCOMs also expressed concern about misuse of lower tariff applicable for EV charging in residential premises.

(d) Technical challenges in the grid due to current/future EV penetration

Technical challenges like voltage fluctuation, harmonics, phase imbalance, power quality, etc., are a major concern in the distribution network to maintain system stability as well as reliability to the consumers. This sub-section highlights DISCOMs' perspective on the technical challenges foreseen in the grid due to current/anticipated EV penetration.

From the interaction, it emerged that most of the utilities currently do not face any power quality issues due to EVCSs with the current penetration of EVs. They, however, mentioned that studies would necessarily have to be undertaken to assess these issues for anticipated penetration scenarios since phase imbalance could be a major concern. They emphasized that three-phase EVCSs should be promoted to address this concern.

(e) DISCOMs as the nodal agency for giving approvals for setting up EVCS in their licensee area

With the EV related developments involving multiple stakeholders, it is important to identify the appropriate nodal agency to anchor implementation of the EV charging infrastructure deployment programme at the state-level. Accordingly, the question of whether DISCOMs should be appointed as nodal agencies in their respective states was put forward to the power utilities at the state-level, including DISCOMs, to have their opinion.

Most of the public and privately-owned DISCOMs unanimously agreed that distribution licensees are the most suitable entities to be made as nodal agencies for granting approvals for setting up EVCS in the license areas. A major public state utility also remarked that DISCOMs have the capability to assess EV loads and initiate appropriate action to absorb these loads by augmenting the distribution network and developing & implementing DSM initiatives. DISCOMs serving a major metropolitan city said that they should be made the nodal agencies for setting up EVCS along with local authority since they know the network very well and EVCS can be planned accordingly; however, the transmission utility is the nodal agency in some states. There were some concerns about the initial investments required in setting up the same and hence the DISCOMs in most of the states who were interacted with remarked that the DISCOMs may be allowed for setting up EVCS in their areas along with the local authorities to create mass awareness amongst public and the costs involved could be passed through by the respective state electricity regulatory commissions.

However, one state nodal agency was of the opinion that it is not necessary to make DISCOMs as the nodal agency for setting up EVCI because their primary role is implementation of charging infrastructure rollout program. However, BEE has finalized 23 DISCOMs as the State Nodal Agencies (SNAs).

(f) Grid infrastructure augmentation in-order to accommodate increased load due to EVCS

The increase in penetration of EVs could increase the load on various distribution network elements such as conductors and transformers. Distribution network augmentation will be necessary to accommodate the increase in load.

Based on the insights gained from the consultations, most of the utility representatives were of the view that as of now, there is no need for infrastructure up-gradation. Few representatives stated that they have

planned in advance to accommodate the EV load while others mentioned that they will plan and develop the system, as and when the EV demand grows in the distribution network and that government support for grid augmentation may be required. Information such as EV concentration and charging behavior would be crucial to plan for grid infrastructure augmentation accordingly.

(g) RE-based power into the EVCS network

The life cycle emissions of an EV depend on the sources of electricity used to charge it. The reduction in emissions will only be possible if a substantial share of the electricity used to charge EVs comes from renewable energy-based generation.

From the consultations, it emerged that most of the utilities feel that energy storage would be needed to ensure that a considerable share of the electricity used to charge EVs comes from renewable energy-based generation while accentuating that the current cost of storage solutions may deter its implementation. One DISCOM indicated that ToU/ToD based tariff could be implemented to encourage EV charging during time slots of high RE generation. One utility is also undertaking a pilot project of integrating existing solar power plants with the EVCS units at their corporate office, as a stepping stone to replicate such solutions across the state.

3.1.2 Financial Aspects

EVCI development requires huge capital costs as of now. Although the DHI, under the FAME-II scheme, is providing full financial support on installing chargers, the aspects relating to revenue realization, managing EV loads using dynamic pricing mechanisms, business models for managing and running the EVCS and impacts on tariffs remain essential for DISCOMs and have been captured through responses to queries on each one of the following:

(a) Managing EV charging load: ToU/ToD pricing versus network augmentation and possibility of using non-wired alternatives like battery energy storage and RE

Most of the DISCOMs opined that ToD/ToU pricing is the most efficient way to manage EV charging load since it will help in shifting this demand from peak to off-peak hours and facilitate better management of the load profile. They were also of the opinion that demand management through this mechanism will lead to better asset utilization ultimately deferring network augmentation costs. Some utilities remarked that such tariffs should be introduced later, when the EV penetration becomes high since during the initial phase the base tariffs should be low to promote adoption of EVs. Appropriate Demand Side Management (DSM) options can also be designed to manage the peak load. Many DISCOMs also supported the idea of using battery storage and/or RE like solar PV for managing EV charging demand. In this regard, TERI carried-out an analysis on estimating the benefits of using rooftop solar PV and battery storage for charging electric buses at bus depots. The possible benefits to the DISCOM in terms of better load management and the savings in bill for the transport operator are shown in Annexure 4.

(b) Business models for installing and operating EV charging stations

Interesting set of observations and suggestions were obtained from the DISCOMs who responded to the query relating to this aspect. Some of the publicly-owned state utilities believed that the PPP model

initially supported by government grants would be required to set up and operate the public charging stations. Among the privately-owned DISCOMs, some of them were of the view that a competitive bidding model wherein a facility or land owner files an Expression of Interest (EoI) to the utility for inviting bids for setting up EVCS on its facility would be a good start to break the market-monopoly early on however the DISCOM supporting a third-party for installing charging stations by providing connection and 100% power supply was also not ruled out as a possibility. Among the remaining private DISCOMs, one felt that installing an EVCS was not viable as of now and hence the cost incurred by the DISCOMs in putting up a charging station must be a pass through in the Annual Revenue Requirement (ARR) filed to the regulator and this would have a negligible impact on the Average Cost of Supply (ACoS). Some of them also referred to the models existing in Europe and the US that may be adopted.

One of the state's public utilities suggested a list of possible models including two modes wherein investors can set up EVCS on land owned privately or that owned by the state government or the utility based on either revenue sharing model or a lease agreement. An implementing agency setting up & managing EVCS with funding from the utility/concerned Departments/ Private Parties was also one of the possibilities mentioned by the DISCOM. Another leading state utility mentioned that places of public activity such as food courts, malls, super markets, etc., need to be brought in while developing a commercially viable business model for developing and running EVCI.

(c) Impact of DISCOM investment in Public Charging Infrastructure (PCI) on electricity tariffs

This was a critical issue regarding which the opinion of the DISCOMs interacted with was divided. Three state public utilities believed that the tariffs will become high as a result of DISCOMs' investment in setting up EVCS in their respective license areas. One state public utility maintained that tariff determination will be contingent upon the quantum of investment however recovery of the same through ARR could be considered; while another remarked that whatever it invests will be passed through in the ARR, as guided by the state's policy and hence some impact on tariff will be expected.

Among the private DISCOMs, one was of the opinion that there would be negligible impact on consumer tariffs while another felt that lower tariffs must be maintained as of now, to encourage EV adoption. However, it also remarked that beyond a certain point, investment made by the DISCOM in PCS will have to be recovered through the ARR. Of the remaining private DISCOMs interviewed, two leading metropolitan city-based utilities highlighted how DISCOM investment in PCS could increase the cross-subsidy burden and raise the tariffs for non-EV users as well. It was remarked that the tariff increase impact across the segments of users could be more significant in the absence of separate ToD/ToU tariffs and recommended regulatory intervention in this regard. In this context, TERI performed a study that has shown negligible impact on the ARR if DISCOMs were to invest in PCI to cater to the EV charging load in their license area. Details may be referred to in Annexure 5.

3.1.3 Regulatory and Policy-related Aspects

The discussions on these aspects were focused on suitable regulatory provisions and possible policy-level instruments to guide the DISCOMs in managing their daily operations to accommodate rising EV charging load with respect to the following key issues:

(a) Increased power-procurement during peak-hours for EV charging-load

Most of the DISCOMs agreed that increased cost of power procurement during peak hours due to additional EV load is a concern for them and most of them were of the view that specific ToD/ToU tariff regime for EV consumers would be effective in managing this situation. However, it was also acknowledged that load segregation is challenging to identify and locate specific EV load demand. One of them also suggested that providing incentives directly to EV users (without GST) and stressed that tariff should not go down below domestic tariff rates. The impact of possible cross-subsidization of consumers due to EV load was also acknowledged and few states' public DISCOMs suggested that tariffs for industrial consumers should also not rise disproportionately. Another leading public DISCOM remarked that suitable tariffs would need to be designed to recover the power procurement costs.

Some of the state public DISCOMs advocated that the government should grant subsidy for peak power procurement due to increased EV load. Few of the utilities remarked that any additional costs involved in peak-power procurement could be a pass through in the ARRs and distributed amongst all consumers. One private DISCOM suggested procuring more RE based power so that the average peak-power procurement cost goes down.

(b) Costs anticipated in augmenting distribution network to accommodate rising EV charging load

Most of the DISCOMs, agreed that suitable financial provisions must be there for them to augment their grid/ network in view of the rising EV charging load. Only one privately-owned DISCOM felt otherwise. On the other hand, the public DISCOMs believed that currently they have ARR as the only option to recover any of the investments they were to make in network augmentation to cater to the increasing EV charging load. The private utilities also seconded this view. However, they emphasized the importance of proper planning by the respective state electricity regulatory commissions regarding this aspect and having alternative means like suitable revenue models to provide financial assistance for network strengthening. They also asserted that upgrading network infrastructure must be carefully assessed and planned in an effective manner considering utilization rates of the newly added assets and the possible impacts of adding them on increase in running cost for bus and taxi fleet operators. One state's public DISCOM explained their strategy to use slow-chargers initially so as to avoid DT augmentation, until it becomes necessary to augment, and the costs for which would be passed through in their ARR. Another state-owned public DISCOM also mentioned that it will be submitting augmentation requirements to the state regulator in its annual tariff petition based on a grid-impact study that it is carrying out.

(c) Alternative revenue and business models for supporting development of EVCI

Three state public DISCOMs maintained that seeking approvals from their respective regulatory commissions for allowing their investments in EVCI development to pass through the ARR did not seem difficult for them. EESL's support in this regard was also highlighted by them. From the other DISCOMs, a mixed-set of opinions was observed. A private and public DISCOM in one state believed that government support would be required akin to other distribution expansion aids provided before, to the publicly-owned utilities in particular. They cited an example of how MoP could continue providing grant until the charger costs go down in the next 2-3 years. Government grants from both the state and central-level would be required, opined another state public DISCOM. However, it also suggested that the Capex

model for setting up EVCSs seemed difficult for them and the PPP model could be a possible model. This was also the opinion of another state's public DISCOM, in absence of any business model favoring the DISCOMs. The PPP/ OPEX model was also considered to be one of the better options under the circumstances by one of the state's public DISCOM. Among the other privately-owned DISCOMs, there were agreements over the fact that any investments made by them for supporting increasing loads are socialized and if the regulatory commissions cannot allow these to be passed through the ARR, then the cost of installation will be totally borne by investors/EV space owner. TERI has done a study in this regard, and it came out that the global business models are not a suitable option because their effectiveness is location and condition-specific and hence they may or may not be the best fit for cases in India.

3.1.4 Recommendations

Most of the DISCOMs recommended a study for detailed analysis of EV penetration into the distribution network. They also endorsed that privately-owned EVs should be charged at domestic tariff and there is no need for a separate connection as well as separate meters for such EV users. ToD/ToU pricing was recommended by most of the utilities in order to manage uncontrolled EV charging. Most of the utilities supported RE plus storage for EV charging as a green energy source while fewer utilities recommended that battery swapping option is better than RE plus storage due to high cost as well as challenges due to intermittency of renewables. On the other hand, fewer utilities recommended that Government should provide grant for new connections/ separate meters, grid augmentation, etc. Further, Innovative technologies like controlled charging/ battery swapping/ V2G, etc., should be explored to help manage utility operations, develop the eco-system and facilitate a wider acceptance. It was also felt that there is a need to develop IT tools to integrate, monitor and process relevant datasets so as to provide a unified picture to all concerned. Additionally, one of the utilities recommended that there should be a proper channel to implement EVCS in the state and being nodal agencies in many states, their roles and responsibilities should be clearly outlined.

3.2. Other Key Stakeholders' perspective

Apart from the issues that pertain to DISCOMs, there are several other dimensions of EV charging infrastructure that are associated with entities other than the electricity service providers. These entities hold an important stake in facilitating development of EVCI including supply of equipment and provision of space, operating and managing the PCI, providing an interface to fleet customers and laying down regulations and standards to ensure that everything is administered under these. Accordingly, eight organizations belonging to the category of relevant stakeholders – OEMs, CPOs, fleet aggregators, OMCs and central agencies/government nodal agencies were consulted in order to get an account of the various issues that they anticipate and how they plan to address them. In this section, the major findings from the responses of these stakeholders have been summarized in order to get a holistic picture towards EVs with an overall comprehension of the issues like technical, financial, regulatory and other aspects that complement those relating to DISCOMs.

3.2.1 Perspective of Central Agencies

The Ministry of Power (MoP) is the nodal ministry that is overseeing the development of charging infrastructure by laying down guidelines, policies and standards. Under the revised guidelines &

standards for charging infrastructure for electric vehicles published by the MoP on October 1, 2019, the Bureau of Energy Efficiency (BEE) was appointed as the central nodal agency for rollout of PCI. It was thus important to consult them for understanding some of the ground-level implementation challenges and accordingly officials of BEE and senior-officers, at the Joint-Secretary level, at MoP were interacted with. Also, the perspective of the agency who has been involved in procuring vehicles and rolling out EVCI was important to gather. Accordingly, a consultation was held with the Energy Efficiency Services Limited (EESL) who has been entrusted with the task of procuring EVs and chargers for the government departments at both the centre and at the states through demand aggregation. A lot of interesting insights on the practical implementation challenges were gathered. These other dimensions relating to EVCI are summarized hereinafter.

(a) Operational Challenges in EVCS Implementation

A significant amount of ground-work has been done by prospective government agencies in the demand-aggregation for EVs and chargers. Therefore, a host of practical issues that arise while implementing EVCI needs to be identified.

As per the prospective agencies, the biggest hurdle in this pathway is to get the new connections for PCS. The utilization rates of the charger are also observed to be a major concern since 40% of the chargers are only utilized while rest remain underutilized. In-addition, the availability of parking space at the PCS for free movement of the vehicle is also a major concern due to which many EV users felt reluctant to stop and charge their vehicles at the public stations. Consequently, proper site-survey for installation of PCS is required beforehand.

MoP/ BEE stressed upon the importance of addressing the operational issues being faced by DISCOMs as well as other stakeholders in the country through a state-campaign program. They also raised an important point of developing a capacity building program in order to build skills in the field of electric-mobility so as to address the shortfall of skilled manpower in this field based on key findings with emerging development in this field.

(b) Business/Ownership models adopted so far

The ownership models and business models for operating the public charging stations will be important for ensuring sustainable growth of the electric mobility sector in the country, apart from technological development. This will also influence consumer preferences and behavioral usage pattern in the context of Electric Vehicle (EV) adoption. Accordingly, the EESL emphasized on two types of business modes that are being adopted -**Pay per Charge** model and **Subscription model**. In the Pay per Charge model, the users are charged at a specific rate per kWh post usage. In the subscription model, packages like monthly pack etc. are available wherein the users get a credit for usage for a particular duration which they can opt for based on their requirements.

(c) Price trend for EVs, batteries and chargers

The high upfront capital cost is the major hurdle when it comes to EV adoption and growth in India. Being the most critical component, battery pack leads and dictates the cost of an EV since its cost is almost 40% of the total vehicle cost. Chargers are another important component whose price trends

affect the development of charging infrastructure. On these aspects, EESL suggested that investors in this market should invest more on importing raw material rather than on assembling the batteries. EESL also believed that investors must support domestic manufacturing under the Make in India campaign as it will decrease the cost of the batteries. According to them, the cost of components in the electric mobility sector will automatically reduce once the market becomes competitive with entry of more and more players, just as the way it happened in mobile phones and solar energy markets. They also expressed their views on battery swapping option as a potential option to reduce the cost of EVs in the near future.

3.2.2 Perspectives of Oil Marketing Companies (OMCs)

OMCs have an important role to play in laying out the public charging infrastructure in the form of public charging stations set up in their fuel stations. These public charging stations would be co-located at the Company-Owned, Company-Operated (COCO) outlets or other privately-owned retail outlets for which the OMCs would provide space and other facilities and either they or any charge-point operator would manage, operate and maintain them. Two prominent OMCs were interacted with and their views on several aspects relating to ECVS development under their mandate and the challenges that they anticipate are summarized under respective heads:

(a) Co-locating EVCS in fuel stations: Regulatory barriers

Establishing EV charging station at a Retail Outlet requires approval from PESO (Petroleum Explosives Safety Organization) under the ambit of Petroleum Rules 2002. There are currently no separate PESO rules as such for the charging station provision at the Retail outlets. A separate application needs to be submitted on case to case basis for each Retail Outlet site to the concerned PESO Circle Office for putting up of charging infrastructure. Currently certain safety rules and standards especially relating to fire safety have to follow for installing electrical equipment near flammable components present at the outlet. The PESO/Petroleum rules, 2002 might require some additional amendments in view of accommodating charging stations at the fuel stations. The OMCs explained the feasibility of installing EV charging stations at the COCO outlets as well as other private fuel retail outlets, located within the city as well on the highways. Furthermore, they expressed their concern on getting the approval from PESO for setting up EVCS at their outlet.

One OMC stated that, in the PESO rules 2002, safety concerns like petroleum outlet's distance from charging station etc. at retail outlet should be considered for necessary revision. The OMCs are trying to coordinate with the PESO Office for issuance of a standard set of guidelines e.g. distance of EV charging point from the dispensing units, underground fuel tanks, norms for cabling layout, electric connection, etc. for setting up of charging infrastructure at Retail Outlets.

(b) Planning strategy for co-locating EVCI with fuel stations and anticipated issues relating to power infrastructure adequacy

The rating of chargers to be installed at each charging station would practically be dependent on the usage pattern that such a PCS would be exposed to. This would depend on the location of the fuel station – city or highway and accordingly the average charging time and parking time would require a different strategy by the OMCs to install EVCS at such locations. The adequate availability of quality and reliable electricity is also crucial.

The OMCs explained that at retail outlets or COCO outlets, located within the city as well on major highways, slow chargers are not feasible because charging time is high (8 hours for one car approximately) and hence it is not feasible to have a single vehicle parked for 8 hours at the fuel station which will create space issues like those at CNG stations. At this moment, the fast chargers are also not feasible for them due to high cost and lesser utilization. It was also discussed that the OMCs would prefer the EVCS to be installed at retail outlets for those states that have an EV policy as well as have an EV tariff order in place with preferably a lower EV tariff. A few ground realities were highlighted since OMCs had their concerns regarding adequate power infrastructure for their fuel stations to cater to the EV charging load.

3.3.3 Perspectives of Cab Aggregators

Private fleet operators are expected to be the frontrunners in rented and shared urban electric mobility, apart from public transportation fleets. These cab aggregators are already popular in India and many all-electric fleet operators have also come up in many cities. Apart from these, the existing app-based operators have included EVs in their fleet and as per the central government's plan, most of them would convert 40% of their fleet to electric by April 2026. One popular app-based cab-aggregator was consulted for its views on electric mobility and the issues anticipated.

(a) Operational planning issues

Obtaining a reliable electricity connection for an EVSE installed at the EV charging station owned and operated by fleet operators was reported to be the major issue. Despite this fact the fleet operators invest into the electrical infrastructure on their own. They highlighted the importance of having arrangements of sub meters at the charging stations.

(b) Tariff related aspects and other regulatory issues

The tariffs for EV charging are different in different states with many states declaring EV as a separate tariff category. In such a situation where these cab aggregators operate in multiple states, it was interesting to note their views on charges applicable to EV charging and revenue realization from different technologies – PCS and battery swapping station.

It was emphasized that EV tariff should be applicable for any mode of EV charging and should be technology agnostic. An interesting suggestion was that demand aggregation in a distributed manner to procure electricity must be allowed through open-access. Further, due to lack of understanding regarding public and captive charging stations, there are speculations among EV owners that charging stations installed by privately-owned fleet operators would charge them at commercial rates even though these fleet operators have never restricted the usage of the stations installed by them. This difference must be understood and made clear by the regulators also.

3.3.4 Perspectives of Charge Point Operators (CPOs)

Charge Point Operators will have a crucial role to play in running, operating and managing the electric vehicle charging infrastructure. They would provide the direct interface to the EV users who would use their PCS to charge their vehicles. Being an important stakeholder, their views on the main issues expected to come up in developing and running EVCI were sought and have been summarized below:

(a) Operational planning issues

Obtaining connectivity from DISCOMs for their EVCS is a pressing issue for the CPOs currently. At many public charging stations, it has been reported that procuring EVSEs including meters and DTs were a difficult and time-consuming process.

(b) Charging standards and Business models

The CPOs currently have the ownership of the charging infrastructure they operate and they follow a **Pay per Use** model, having different variants for revenue-realization from charging infrastructure. Despite sourcing chargers from OEMs globally, the interviewed CPOs also have their own chargers that follow different type of charging standards like CCS, CHAdeMO and Bharat charger, including the open charge protocol for providing service.

(c) Payment method/ Tariff:

Digital payments through smart-phone based mobile applications are being followed by most CPOs. However, battery swapping vs. PCS and corresponding pricing mechanisms is an important consideration.

During our interaction, one of the CPOs explained the mode of payment used at their PCS. All of their installed charging stations are mapped online. This makes it easy and convenient for EV owners to find out availability of chargers, types of chargers and their location through a smart-phone application. The payments are digitally made, post the usage, also through the same app. Apart from pricing method, charging technology and battery swapping as an option was also discussed. Battery recycling was discussed since the CPO is using recycled batteries as a stationary storage but these batteries cost higher than fresh/new batteries.

3.3.5 Perspectives of Original Equipment Manufacturer (OEMs)

In order to envisage growth of EVs in India, it is imperative to get holistic overview from OEMs about the various segments related to EVs implementation such as consumer behavior, charging scenarios, battery capacity, type of chargers, etc. With this view, inputs from two OEMs were sought. According to one of the OEMs, EV chargers are being manufactured as per all the available standards in India and they are also supplying the same in international market. Further, both the OEMs opined that battery swapping is an effective option and can be rolled out once the complete ecosystem using universal set of standards & protocols is prepared. They also expressed their views on appropriate tariff structure and mentioned that a unified tariff rate across the country would be a viable option. Moreover, they also made a mention of the operational issues arises due to random charging due to which many of the DISCOMs may not allow the charging of EVs from their network. Besides, they expressed their views on vehicle to grid (V2G) technology and stated that implementation of V2G can face obstacles since the country is still lacking in smart grid infrastructure. Another OEM mentioned factors such as battery size, driving range/charge for different type of vehicles (3 wheelers & 4 wheelers) being important. They anticipated that 3 wheelers segment will see a huge demand in short term and the growth in 4 wheelers EVs will be comparatively slow since the government has set up an ambitious target of 100% electrification for 3W by 2023 and 100% electrification for 2W (<100 cc) by 2025. They further stated that the decline in the battery price has

been the key driver in EV's price reduction in the last 5 years. However, going forward the decline may not be expected to be as rapid as seen in the last 5 years. They opined that the price parity has been seen in the 3W and the shared 4W segment in terms of Total Cost of Ownership (TCO).

3.3.6 Recommendations

Most of the stakeholders recommended that DISCOMs should cooperate for taking new connections and Government should provide grant for upgrading grid infrastructure. Further, the OMCs recommended performing a study on economic model for EV chargers at retail outlets considering Capex & and other Opex based on global scenario. In addition, other major OMCs recommended that EV tariff should be specified in every state and the safety parameters need to be considered.

Cab aggregators recommended that LT category should stretch its maximum limit and for HT category, fixed charges should be zero or remain constant, if operators upgrade the grid at their own cost; otherwise it should be considered as LT category. Further they suggested battery swapping stations should be eligible for EV tariff and the regulator should take initiative for availing EV tariff. On the other hand, the CPOs recommended that DISCOMs should focus on up-gradation of the grid infrastructure, else government should support CPOs. Additionally, OEMs recommended that incentive should be considered for EV registration and there should be exemption in state tax & toll charges.

4. IMPACTS OF EV CHARGING ON DISTRIBUTION NETWORK: INSIGHTS FROM MODELLING & SIMULATION STUDY FOR A SELECTED UTILITY AND ON-SITE PQ MEASUREMENTS

4.1 Purpose of the study and field-measurements

The previous chapters provided a comprehensive view of the EV landscape in India including some account of global best-practices, major findings of some related studies and the various issues that different stakeholders anticipate regarding EVCS development and operation. Chapter 2 specifically highlighted major findings and recommendations of some international and national studies on grid-related impacts of EV charging – technical, financial and regulatory. While all the studies covered in chapter 2 mostly looked at the impacts of rising EV penetration at a broad system level – national grid, city-wise demand impacts and feeder-level impacts for a few utilities, it is important to study the same in a more granular manner, specific to charging management and power-quality issues. Hence, it was felt that studying the localized impacts of EV charging on the partner utilities' networks, under the forum, would be of value to key stakeholders.

Accordingly, a modelling and simulation study analysing the impacts of co-ordinated EV charging on network management was carried out along with a set of power-quality measurements taken at a few sites. Important insights were gathered from these set of studies regarding (a) how network-congestion and local transformer loading should be reflected in EV charging tariffs, (b) how charging cost and network-operation can be optimized using co-ordinated charging, (c) what is the effect of charging pattern on local power quality, etc. This chapter provides results of the modelling and simulation study and major observations from the on-site power quality measurements with the key takeaways.

4.2 Modelling and Simulation Study on Smart Charging Management

Optimal planning and operation of EVCS(s) is an important factor associated with development of the EV eco-system. However, it is equally important to ensure that the charging schemes being deployed do not adversely affect the distribution grid and are beneficial for both the power distribution utilities and the EV customers. The impact of EV charging on a distribution network is usually dependent on driving patterns, charging characteristics, time of charging and the EV penetration level. The charging schedule must therefore fundamentally ensure that the driving schedule and driving range requirements are satisfied with minimum impact on distribution equipment loading and peak power purchase.

Uncontrolled charging (UCC) is unregulated or random wherein all the EVs plug-in when they arrive at a charging station and charge at the maximum charging rate subject to battery State of Charge (SoC) and other parameters. In case of privately owned EVs, users would plug-in as soon as they reach home and this would contribute to an increase in peak demand resulting in an increase in **peak power purchase** as well as **distribution network congestion**.

Coordinated and controlled (CC) charging could be implemented by communicating different charging rates to individual EVCSs. These tariff rates are usually made to reflect the cost of peak power purchase during peak demand. However, this type of charging scheme does not consider local network conditions such as transformer and conductor loading. EVCSs could be supplied by Distribution Transformers (DTs) which have a peak load that does not coincide with the utility peak or slots wherein the Distribution licensees have to purchase expensive peak power. In this study, a charging scheme that considers the impact of both peak power purchase as well as network congestion has been proposed.

4.2.1 Objective of the study

The objective of this study is to explore the role of distribution utilities as fleet operators to ensure a seamless integration of EVs through CC charging through EVCSs. This study highlights the difference between a controlled & coordinated (CC) charging scheme and an uncontrolled & uncoordinated (UCC) charging scheme while presenting the DISCOM level financial impacts such as reduction/increase in peak power purchase as well as techno-commercial impacts such as transformer overload reduction for each of the aforementioned charging schemes.

4.2.2 Methodology

Test System

To carry out this study, a section of electricity distribution network of CESC Limited that mostly caters to residential load was considered. Figure 13 represents a simplified single line diagram (SLD) of the test case. This section of the network begins with a Distribution Substation (DS) that consists of a 20 MVA transformer which steps down the voltage from 33 kV to either 11 kV or 6 kV. This power transformer consists of six outgoing feeders each consisting of eight to ten 11 kV or 6 kV /415 V Distribution Transformers (DTs) each having a rating of either 315 kVA or 400 kVA. The total number of DTs in the network is 50 and the EVCSs are assumed to be connected at the secondary side of the DT.

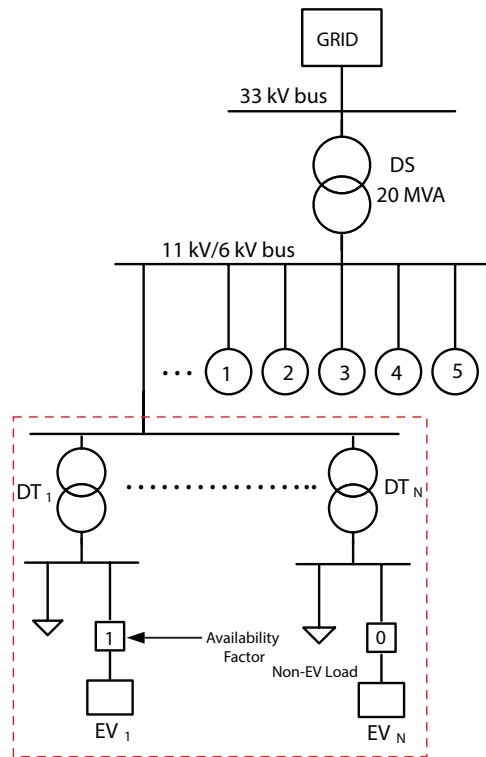

Figure 13: Single Line Diagram of the test system

An availability factor was considered to model whether or not an EV is connected to the DT at any time. It is a binary parameter which defines the availability of an EV to charge- one, if the EV is parked at the residential parking lot and zero otherwise. This basically shows the status of the switches A to A(N) in Figure 14. In other words, each switch is either on or off depending on whether or not the EV is parked at EVCS. This is expressed algebraically as:

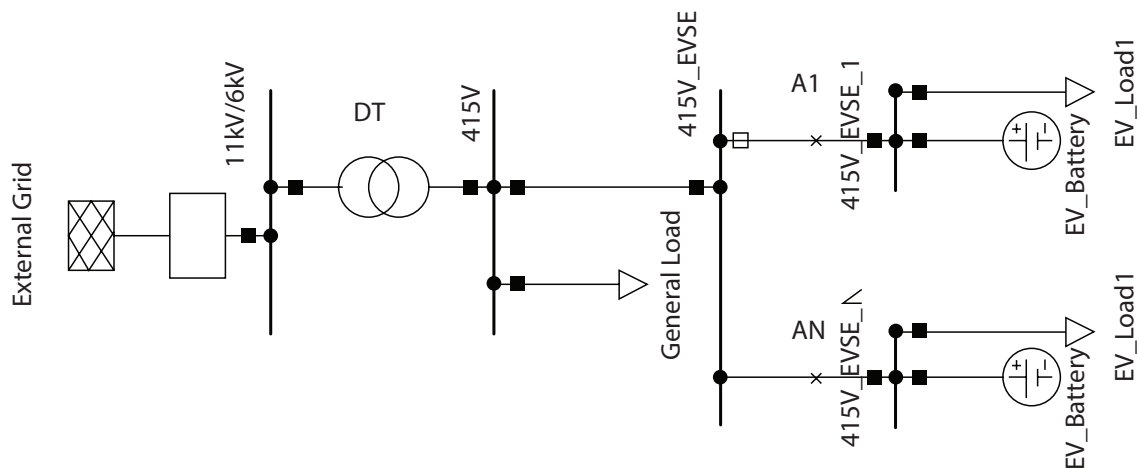

Figure 14: Arrangement of EV charging stations placed on the DT network

The EV charging rate at any instant is limited based on the Battery State of Charge (SoC) and the charger rating. It is assumed that the charge rate is limited by the charger rating and maximum C-rate of the battery in the red portion of the plot, shown in figure 15, and by the battery SoC dependent charge rate of the battery in the yellow portion of the plot. The charge rate has been represented in per unit, where the absolute value is normalized by respective limiting factors in each of the two regions of the characteristics curve.

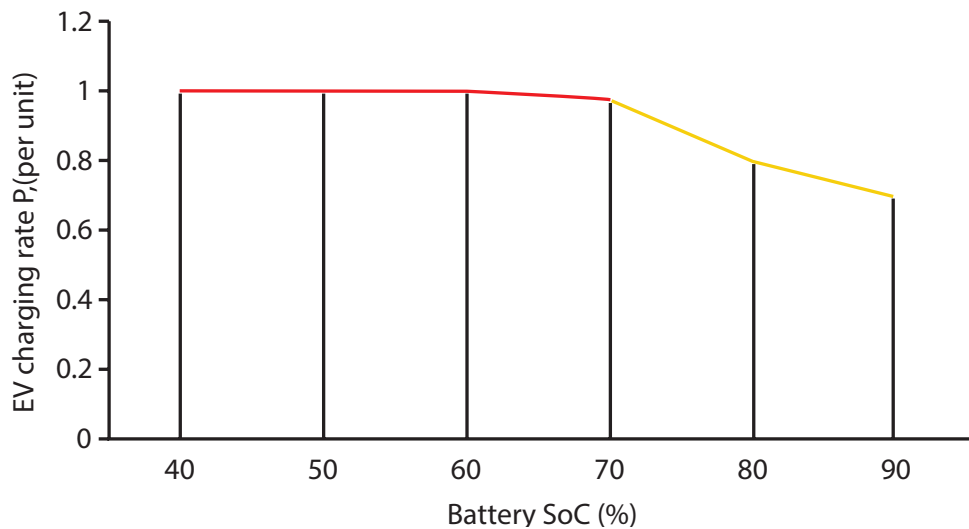

Figure15: The EV charging characteristics modelled in the study

EV Scenario

Three most popular EV models (Four-wheelers) available in India were considered in this study to obtain the vehicle charging characteristics modelled for simulation. The charger ratings considered were 3.3 kW for AC or slow charging and 15 kW for DC or fast charging.

The number of each EV type sold was used to obtain the probability of occurrence of a certain type of EV. Similarly, the same was also carried out for the rating of the EV charger (3.3 kW or 15 kW) supplying an EV for a particular charging scenario: CC or UCC. EVs were assumed to leave and return to a certain residential area at different time stamps, as per the scenario formulation. A survey was carried out in the licensee area to obtain the probability of arrival time, departure time and distance travelled in a day. This information was used in formulating the scenarios.

A stochastic model was developed considering the probabilities mentioned above. This was obtained from the afore-mentioned survey of 30 working individuals that was carried out in the locality. The probabilistic model for the EV charger can be extended based on Monte Carlo simulations for a number of repetitions using the probability distribution values mentioned above. The probabilities for the arrival and departure of the vehicles at different hours of a day are shown in figure 16.

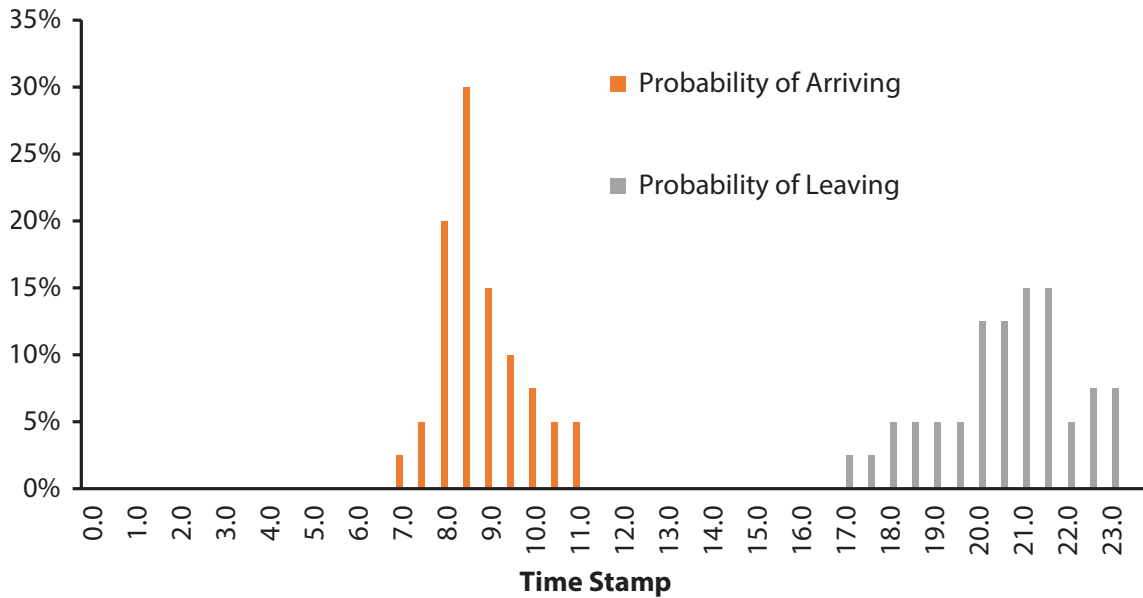

Figure 16: Probability arrival and departure

The probability distribution of distances travelled by the vehicles in a day (based on the survey and rounded to the nearest multiple of 5) is shown in figure 17. This probability distribution was arrived at after obtaining a realistic estimate of the probable routes and the daily routine of the residents of the locality, if they were to use EVs, based on their present travel patterns.

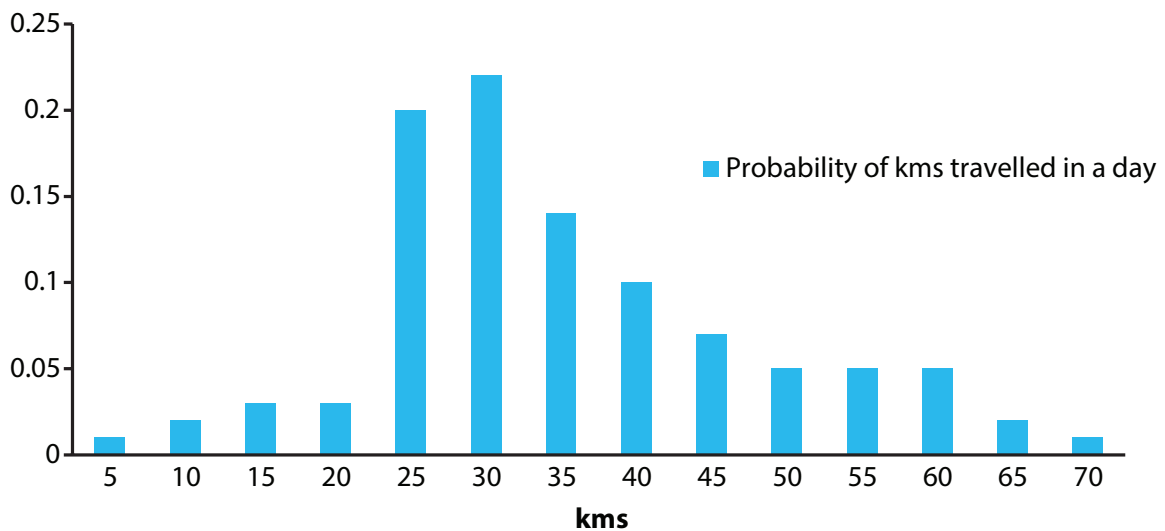

Figure 17: Probability of Distance travelled in a day

Problem definition and Formulation

A time varying price of power (Rs/kWh) was needed to model the power purchase cost to the DISCOM at different time stamps. Since the historical power purchase cost data, as per the DISCOM's Power Purchase Agreements (PPA) was not available, IEX rate for the eastern region (E1) was considered in this study. Figure 18 shows the same for the entire simulation period.

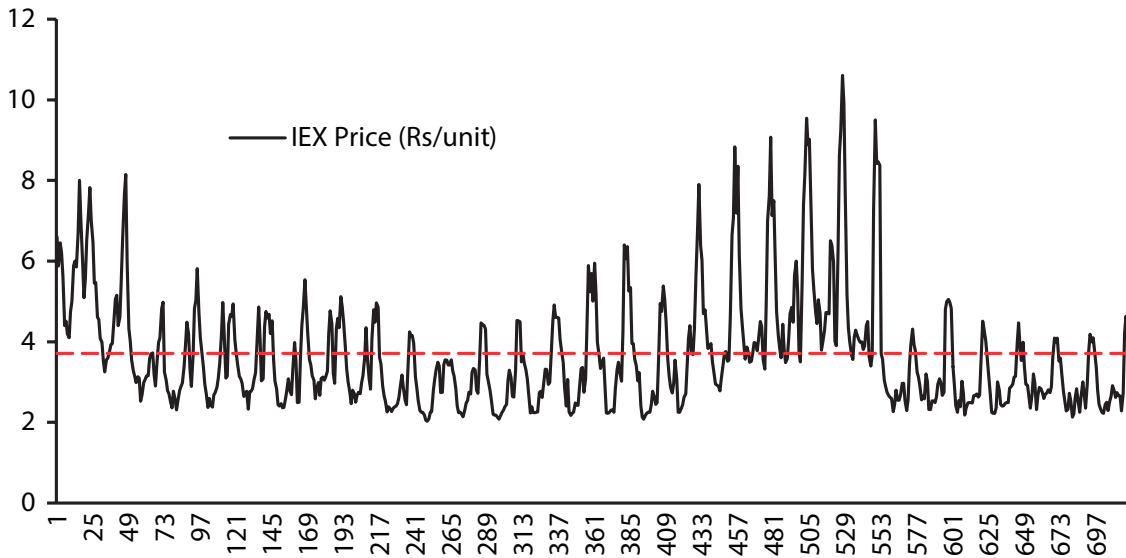

Figure 18: IEX Rate for the Eastern Region

As seen in figure 19, the average of the IEX price for each time slot for the entire simulation period of 15 days in June 2019 was calculated to understand the trend in IEX power price.

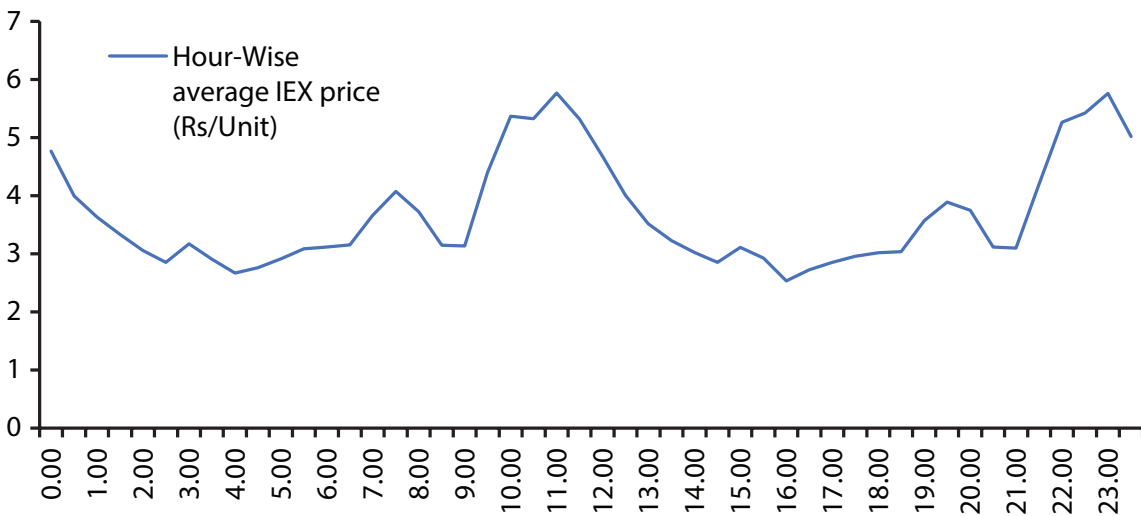

Figure 19: Hour-Wise average IEX price

In the proposed controlled and coordinated (CC) scheme, the total cost of EV charging in Rs/kWh at any time stamp is composed of two components:

1. The time dependant power purchase rate (Rs/kWh) and;
2. The Shadow price (Rs/kWh) associated to distribution component loading
3. This cost is expressed as:

$$C(t) = ToD(t) + C_L(t)$$

Here $C(t)$ is the cost of charging an EV at time stamp. The shadow price (Rs/kWh) is the cost associated to overloading the upstream distribution system equipment. In this study, the distribution system equipment that has been considered is Distribution Transformer and Distribution substation transformer or Power transformer. Hence a shadow price or penalty is assumed to be levied if an EV is charged during overloaded instances of a Distribution Transformer or an upstream Power transformer. This would encourage EV users to participate in this proposed scheme. The total shadow price associated to the loading of all distribution equipment can be expressed as:

$$C_L(t) = C_{LDT}(t) + C_{LDS}(t)$$

The role of EV fleet operator (FO) or the DISCOM in this case is as follows:

1. Guarantee driving needs of the EV owners
2. Implement centralized control to minimise peak power purchase due to EVs
3. Optimize the charging process of EVs to reduce the cost of distribution network component augmentation.

The aforementioned shadow prices C_{LDT} and C_{LDS} can be proportional to distribution transformer and distribution substation loading, with a negative shadow price or rebate associated with time stamps that correspond to DT or DS loading below the average value.

The negative shadow price is associated to formulate the optimization problem to encourage charging during lower local loading instances, below the average load. The positive shadow price can be collected when EVs charge during higher loading periods. This amount can be used by DISCOMs in distribution equipment augmentation, through certain regulatory interventions.

Hence the cost of DT augmentation due to overload caused by EV charging would have to be borne by EV users that do not participate in the proposed charging scheme.

This study has assumed only a positive shadow price that corresponds to DT and DS overloading. Depending on the priority of either local overload reduction or reduction in peak power purchase the values of C_{LDT} and C_{LDS} can be set. In this study, the priority was to prevent the over-loading of local distribution equipment hence C_{LDT} and C_{LDS} assumed to be relatively higher than the maximum IEX power purchase price.

C_{LDT} & C_{LDS} were assumed to be 10 Rs/kWh and 12 Rs/kWh for instances of overload of the DT and DS respectively. This can be expressed as:

$$C_{LDT}(t) = \begin{cases} 10 \text{ INR/kWh, if DT loading} > 95 \% \\ 0, \text{ otherwise} \end{cases}$$

$$C_{LDS}(t) = \begin{cases} 12 \text{ INR/kWh, if DS loading} > 90 \% \\ 0, \text{ otherwise} \end{cases}$$

The optimization problem is formulated as an optimal scheduling problem and the scheduling horizon considered is 24 hours for 15 consecutive days in the month of June. Each interval is of half an hour duration. This optimization exercise will result in different charging schedules with different charging rates at each hour t , for each EV. Any resulting charging schedule will be considered to be feasible when both the EV traction demand and the system load requirements are satisfied along with other constraints.

The UCC scheme represents the charging mode in which all EVs start charging as soon as they arrive and stop charging as soon as they reach the target SoC which is expressed as $D_{\text{next day}} \times \frac{\text{kWh}}{\text{km}}$. Here $D_{\text{next day}}$ is the distance to be travelled by an EV for the next day. The power at which each EV is charged is determined by the charging plot in figure 14. The charging rate is a function of SoC and the maximum charging rate. The objective for individual chargers is to decide the optimal charge rate at each time stamp, so as to minimize the total charging cost. This has been formulated as a linear programming problem expressed by the following objective function:

$$\min \sum_{i=1}^N \sum_{t=1}^T \left(T_{oD}(t) \times \frac{P_i(t)}{\eta} + C_L(t) \times P_i(t) \right) \times t \times a_i(t)$$

subject to the following constraints:

$$E_i(t) = E_i(t - 1) + Ech_i(t) - Etr_i(t)$$

$$0 \leq E_i(t) \leq a_i(t) \times \eta \times P_i(t) \times t$$

$$E_{iMin} \leq E_i(t) \leq E_{iMax}$$

The first constraint relates to energy balance for the i^{th} EV in terms of the charging and the traction requirements at a time step. The second constraint ensures that this energy for each EV is bounded by the actual value being drawn based on the charging rate and the availability factor. The last constraint enforces the upper and lower limit of the battery state of charge with respect to the battery capacity.

4.2.3 Scenarios

To generate EV scenarios using TERI's stochastic EV scenario generation model considering the arrival time, departure time and distance travelled by each EV, the following assumptions had to be made.

- ❖ Number of DTs with EVs
- ❖ Number of EVs in each DT

Table 17: EV Scenarios

Scenario(s)	Number of DTs with EVs	Number of EVs at each DT	Total number EVs
Scenario 1	30	15	450
Scenario 2	50	7	350

In Scenario 1, the number of DTs with EVs was assumed to be 30 (out of a total of 50 DTs) and 15 EVs were considered to be charging through each of the 30 DTs. Hence, the number of EVs in this scenario was 450. While in Scenario 2, all the 50 DTs were assumed to be with EVs and 7 EVs were considered to be charging through all the DTs. Hence, the number of EVs in this scenario was 350. The results and observations have been presented for scenario 1, while snapshots of the same for scenario 2 are a part of Annexure 6.

4.2.4 Results and Observations

The two major impacts to DISCOMs due to increase in EV penetration are increase in peak power purchase as well as distribution network congestion. In this regard, the following analysis has been presented for both the CC and UCC scheme:

- ❖ The increase in Distribution Station (DS) and Distribution Transformers (DTs) load due to EV penetration for each scenario in each time stamp for the simulation period.
- ❖ The corresponding impact on power purchase cost due EV charging

Scenario 1

Impact on Distribution Sub-Station (DS)

This section presents the corresponding changes observed in the loading on the Distribution Station (DS) in both CC and UCC charging. This loading pattern was compared to that corresponding to the base loading where no EVs are present on the feeder.

The first scenario considered 30 DTs on the DS, each having 15 EVs. The results of the loading on the DS (for one of the days covered in scenario 1) due to charging of 450 EVs is shown in figure 20 below. The loading on the DS in the base case wherein no EVs are present is shown alongside. The corresponding IEX prices are also plotted. It can be seen that the 20 MVA DS is overloaded for certain hours of the day.

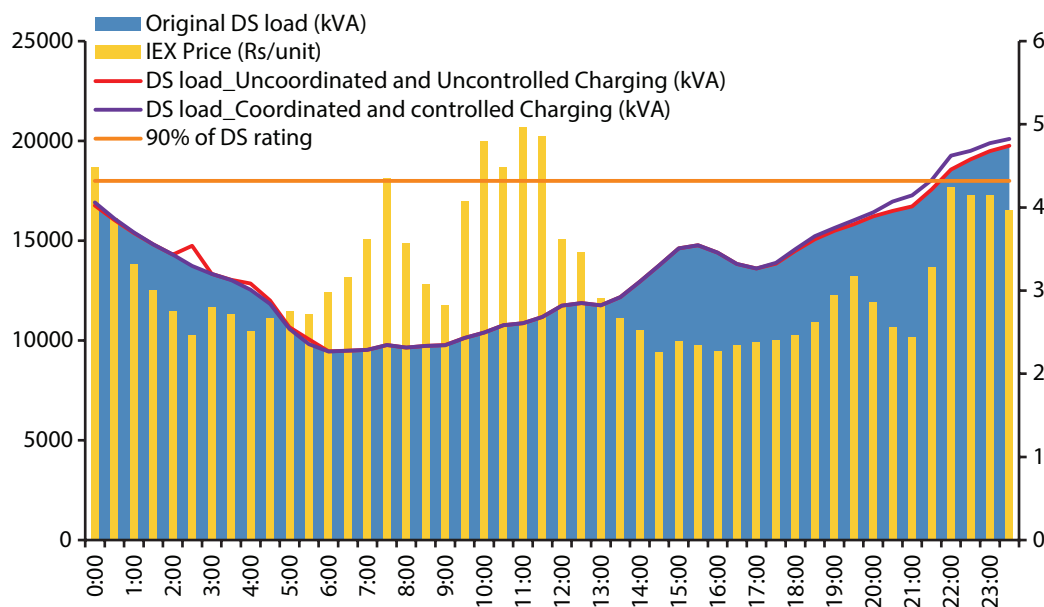

Figure 20: loading on the DS, in scenario 1

The CC scheme ensures that the vehicles do not charge during the period when the DS is overloaded however ensuring that the overall cost of power purchase is also the least. Accordingly, the scheme alters the charging rates to be on the higher side when the IEX prices are low. The travel pattern in terms of arrival and departure times of the EVs was obtained through a survey however the number of vehicles plugging in and moving out at particular instants of time was estimated using a stochastic model based on likelihood of movement in the locality. The UCC charging scheme tends to further overload the DS during evening hours when the load on the network comprising of mainly residential load, increases. On the other hand the peak load does not increase in the CC scheme wherein EVs tend to charge during time stamps wherein the DS is not overloaded and the electricity price in relatively low.

The charging power for a set of 5 EVs charging at specific hours of the day for both UCC and CC schemes in the first scenario has been shown in figure 21. The total power for both the UCC and CC schemes is also shown. It can be observed that the coordinated charging scheme alters the charging rates to be optimally positioned during the hours of the day when the IEX prices are less and the loading on the DS and DT is relatively low.

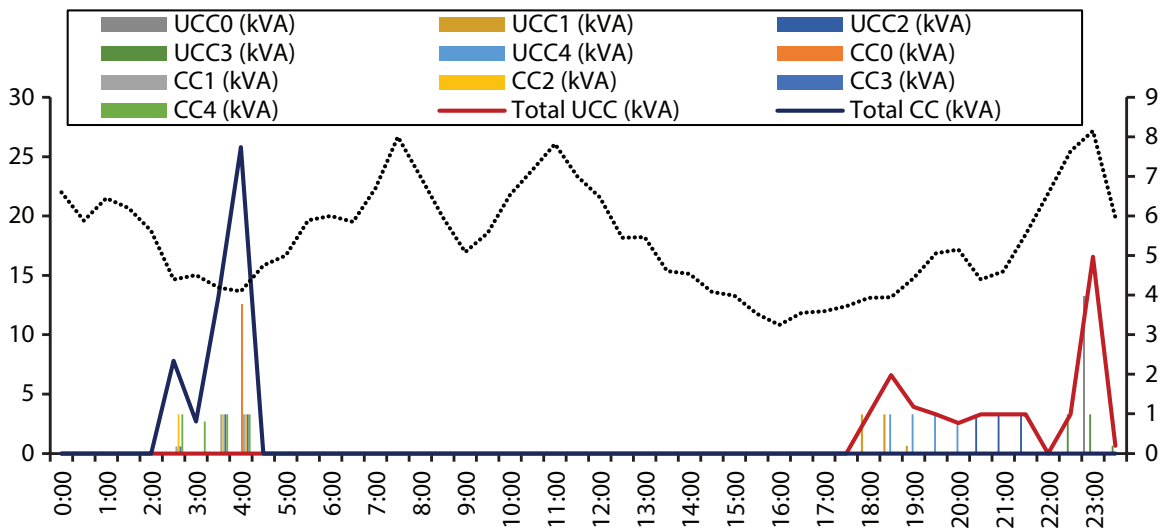

Figure 21: Charging power for 5 EVs under both UC and coordinated charging schemes for a day under scenario 1

Impact on Distribution Transformer (DT) load

This section presents the corresponding changes observed in the loading on the Distribution Transformer (DS) in both UCC and CC charging. This loading pattern was compared to that corresponding to the base loading where no EVs are present on the feeder.

The resulting Load curve for one of the 50 DTs has been shown in figure 22 for one day during the simulation period while figure 23 shows the same for a different DT. The base loading of the DT and the Eastern region IEX prices for the corresponding hours are also shown.

The UCC charging scheme tends to further overload the DT during evening hours when the load on the network comprising of mainly residential load increases. On the other hand, the peak load does not increase in the CC scheme wherein EVs tend to charge during time stamps where the DT is not overloaded and the electricity price is relatively low.

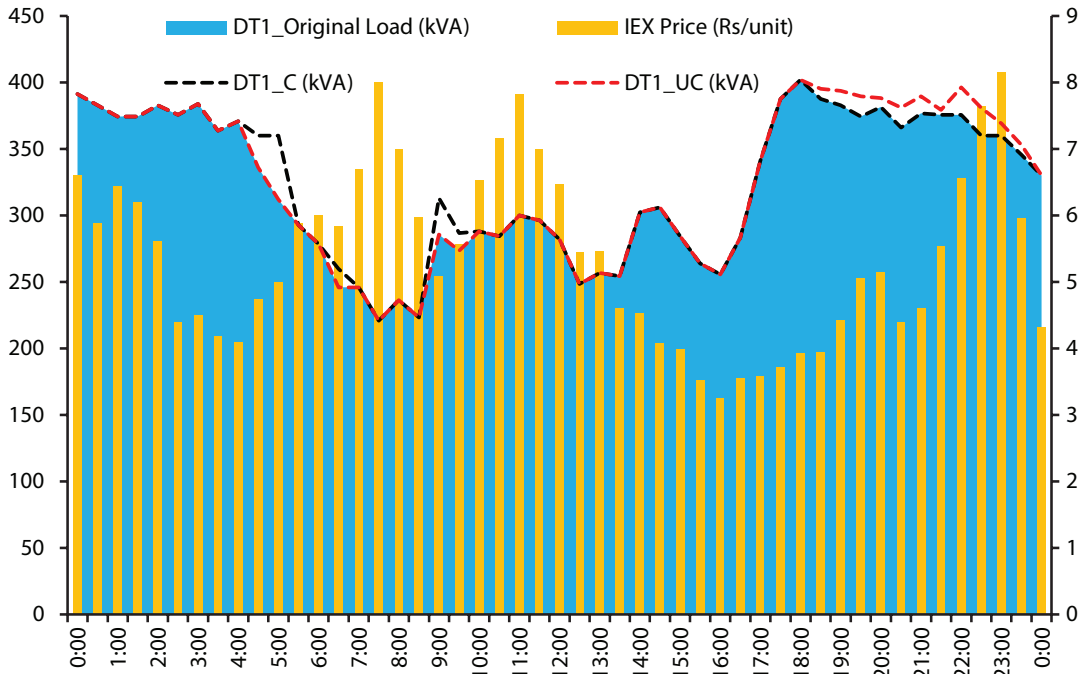

Figure 22: Base loading on DT1, Loading with UCC and CCEV charging and corresponding IEX prices for another day in scenario 1

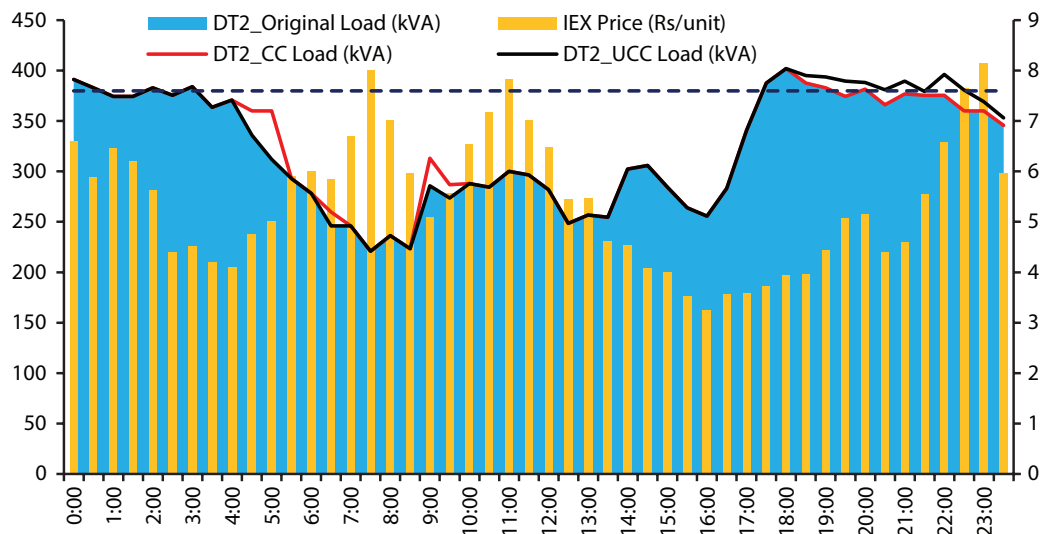

Figure 23: Base loading on DT2, Loading with coordinated and uncoordinated EV charging and corresponding IEX prices for a day in scenario 1

Impact on Power Purchase cost

The total charging cost is optimized by the coordinated charging (CC) scheme. Accordingly, the scheme alters the charging rates for the EVs, charged under the desired travel schedule, in such a way that the total charging cost is the least (incorporating both IEX procurement prices and distribution equipment loading based shadow pricing) and also ensuring that the DTs and the DS are not overloaded. Figure 24 shows the total charging cost resulting from charging the 450 EVs for a particular day under scenario 1. It can be seen that because of the charging strategy resulting from the coordinated scheme, the total charging cost is on the lower side and the charging of EVs is not spread across a large number of hours of the day. On the other hand, the uncoordinated or random charging scheme leads to a higher total charging cost spread across a greater number of hours. The corresponding IEX market prices are shown in the dotted graph.

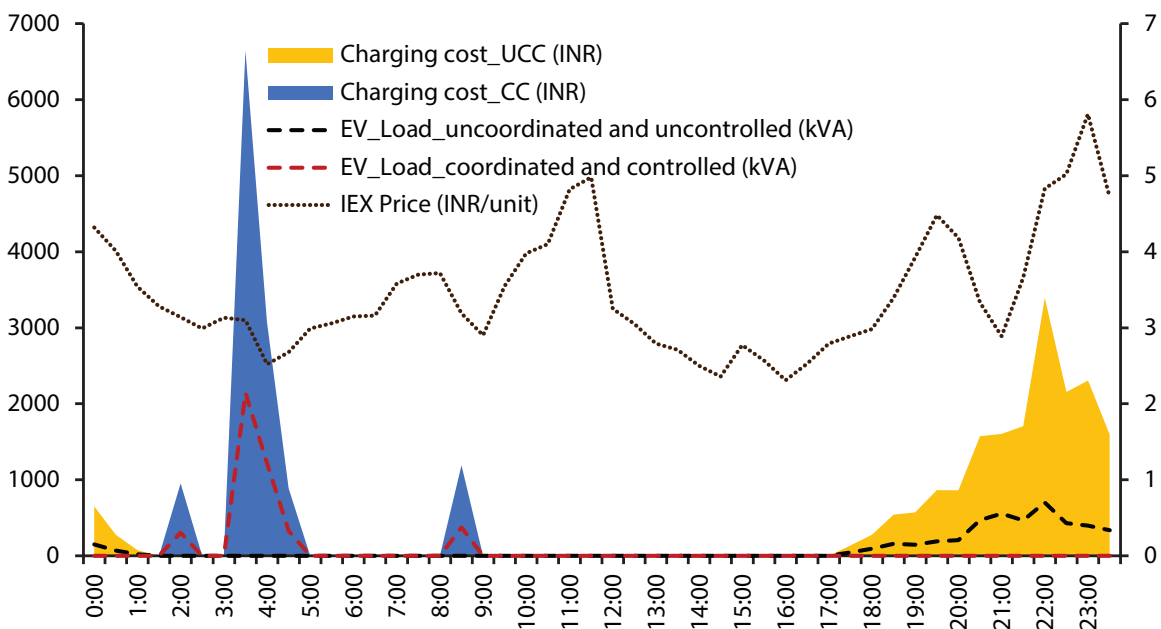

Figure 24: Total charging costs for both UCC and CC schemes for a day under scenario 1

Observation

Table 18 summarizes the effectiveness of the CC charging scheme over the UCC scheme in both scenario 1 and scenario 2. The latter resulted in an increase in the DT load during already overloaded time stamps or caused DT overloading altogether. This increase from the base case was slightly higher in scenario 1, with 450 EVs compared to 350 EVs in scenario 2. The UCC scheme also resulted in a 6% increase in DS overload in both the scenarios. Moreover, the cost of EV charging (Rs/kwh) in the CC scheme was substantially lower than that in the UCC scheme.

The detailed results and observations for scenario 2 are provided in Annexure 6.

Table 18: Summary of results

Parameters	Scenario 1		Scenario 2	
	UCC	CC	UCC	CC
% Increase in DT overload instances	5%-22%	None	4%-14%	None
% Increase in DS overload instances	6%	None	6%	None
Cost of EV charging (Rs/kWh)	4.3	2.7	4.2	2.5

4.3 On-Site Power Quality Measurements

Recent breakthrough in the electric vehicle (EV) technology and affordable battery storage have shown a hope of mass level adoption of EVs and therefore, adequate charging infrastructures establishment is required. However, charging a large number of EVs through grid could have adverse impact on distribution network since an EV charger will have inbuilt power electronic devices, which can give rise to power quality issues (harmonics, voltage/current unbalance, flicker, etc.) due to switching operation of electronic switches (IGBT/MOSFET). Therefore, power quality parameters of EV charging stations needs to be investigated, considering impact of fast & slow charging along-side number of vehicles being charged. Additionally, random charging of vehicles will create an operational challenge for distribution utilities in terms of managing network congestion, overloading of distribution assets etc. Further, non-linear load operation due to power converter's switching operation has significant impact on harmonics injection into the network since it produces non-sinusoidal current & voltage waveform which results to additional heating losses into the distribution equipment, particularly in transformers. It is therefore imperative to examine the impact of harmonics on service life of distribution transformer (DT) since it is most expensive component of distribution network. Generally, harmonics are directly related to heating losses in the winding, eddy current & stray losses in the magnetic core of DT. It is thus recommended to maintain the individual harmonic component as well as total harmonics distortion within specified limit as per IEEE-519:2014, mentioned in table 19 & 20 respectively. Furthermore, voltage imbalance is recommended to be 3% as per American National Standard for Electric Power Systems and Equipment ANSI C84.1. Since, there are no standards available for current unbalance however as per NEMA MG-1 standard, the maximum standard limit of current unbalance due to 3% of voltage imbalance can be advised as 30%.

Table 19: Voltage distortion limits under IEEE 519

Bus Voltage at PCC (V)	Individual Harmonic (%)	Total Harmonic Distortion THD (%)
$V \leq 1 \text{ kV}$	5.0	8.0
$1 \text{ kV} \leq V \leq 69 \text{ kV}$	3.0	5.0
$69 \text{ kV} \leq V \leq 161 \text{ kV}$	1.5	2.5
$161 \text{ kV} \leq V$	1.0	1.5

Table 20: Current distortion limits under IEEE 519

Maximum Harmonic Current Distortion in % of I_L						
Individual harmonic order (odd harmonics)						
Isc/IL	$3 \leq h < 11$	$11 \leq h < 17$	$17 \leq h < 23$	$23 \leq h < 35$	$35 \leq h < 50$	TDD
< 20	4.0	2.0	1.5	0.6	0.3	5.0
20 < 50	7.0	3.5	2.5	1.0	0.5	8.0
50 < 100	10.0	4.5	4.0	1.5	0.7	12.0
100 < 1000	12.0	5.5	5.0	2.0	1.0	15.0
>1000	15.0	7.0	6.0	2.5	1.4	20.0

Isc: maximum short circuit current at point of common coupling (PCC)
 IL: maximum demand load current (fundamental frequency component) at PCC

Transformers are designed to supply required power to load with minimum losses at fundamental frequency since the stray losses and eddy current losses are inter-dependent on harmonic content and increases with higher frequency component. Further, the DT’s loss-of-life (LoL) estimation method has been reported in literature⁴⁵ on the basis of some empirical formulas. It is perceived that DT’s service life will be significantly reduced due to higher order harmonic current into the system due to higher eddy current and hysteresis loss factor as expressed by empirical formulas mentioned in this paper.

4.4 Effects of harmonics in the supply

The following are some of the effects of harmonics on the distribution network⁴⁶

- ❖ Nuisance tripping of branch circuit breaker
- ❖ High voltage and circulating currents caused by harmonic resonance
- ❖ Capacitor bank failure
- ❖ Excessive heating of distribution asset
- ❖ Crest factors and related problems
- ❖ Skin effect on cables for higher harmonic order
- ❖ Reduces the system power factor, resulting in penalty on monthly utility bills

4.5 Selection of utilities and site(s) for PQ measurement & analysis

In-order to analyze the aforesaid impact of EV charging station, two of the largest metropolitan cities of country i.e., Delhi and Kolkata were selected for on-site measurements & analysis. The cities have been facing extreme air quality issues due to large number of private and commercial vehicles, especially two

⁴⁵ <https://ieeexplore.ieee.org/document/5356577>

⁴⁶ [https://www.newark.com/pdfs/techarticles/eaton/Eaton_Technical_Articles/UPS_Training/Power are Training/HarmonicsInYourElecSystem.pdf](https://www.newark.com/pdfs/techarticles/eaton/Eaton_Technical_Articles/UPS_Training/Power%20are%20Training/HarmonicsInYourElecSystem.pdf)

wheelers and four wheelers and extensive growth in the EVs is expected. EV chargers installed at two different places in licensee area of major distribution utility (BSES Rajdhani Power Ltd.) in New Delhi, were selected for measurements. One of the charging stations is located at Palika Kendra under New Delhi Municipal Corporation (NDMC) in New Delhi and nthe other in the vehicle parking area of BRPL's corporate office at Nehru Place.

In case of Kolkata, the West Bengal Transport Corporation (WBTC) has already procured 80 electric buses which are operational in the city. The electric buses are distributed in 10 bus depots (8 buses in each depot) located at different places in the city. Eight out of ten depots are having one DC fast charger (DCFC) and 6 DC slow chargers (DCSC) each. Whereas, Nonapukur is having 7 DCSC, Howrah and Tollygunge each are having 2 DCFC. Further, a public bus depot located at Kasba region, has been selected for field measurement & analysis. The electricity access to the bus depot has been provided by Calcutta electricity supply corporation (CESC), a Kolkata-based flagship company.

4.5.1 Measurement & analysis of EV's chargers installed in parking lot of BRPL's Corporate Office

Four EVSEs (2 AC L2 and 2 DCFC) are installed and operational in the parking lot of BRPL. The main objective was to analyze the impact on power quality (primarily unbalances and harmonics) with an increasing number of PEVs connected to the EVSEs at various times during the test. The total duration of measurement was 1 hour with the sampling time of the power analyzer set as 10 seconds.

Charging of four PEVs was monitored: manufacturer A (PEV1 and PEV2) and manufacturer B (PEV3 and PEV4) with the charging sequence shown in figure 25. The setup of the charging network and the phase sequence at the inlet and the outlet of each charger are also shown in same figure, 1-2-3 and A-B-C is the outlet sockets of the L2 chargers.

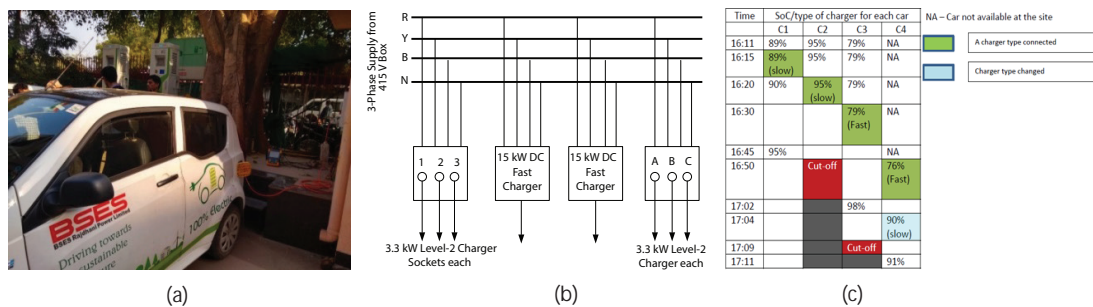

Figure 25: (a) EV charging station in BRPL parking lot (b) Connection diagram of the facility providing supply to L2 and DCFC (c) EVs charging scenario

The measurements were made at the terminal points and the input cables of the 415 V Low Voltage (LV) distribution-box that feeds the four chargers as shown in figure 24. Three cars were parked in the office premises at the start of the measurement while the fourth one had returned from its ride midway during the process of measurements. A commercially available power analyzer (Fluke) was used to measure voltage/current unbalance and harmonics (1st to 30th order).

Observation(s)

Power flow through all three phases is depicted in figure 26 and it can be observed that power flow through the phases is not symmetrical across the measurement time.

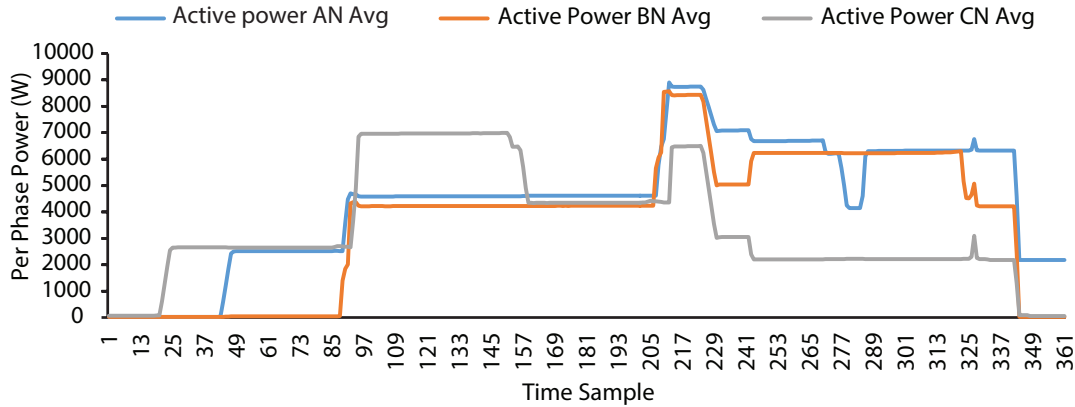

Figure 26: Variation in per phase power observed at different time slots (1st DCFC on at 121st instant at 4:30 PM) for BRPL on-site study

Voltage/current unbalance: Maximum current unbalance is approximately 90% when power is being supplied only through phase C as it is shown in the figure 27 and the limit for current unbalance is 30% to prevent the overheating of equipment.

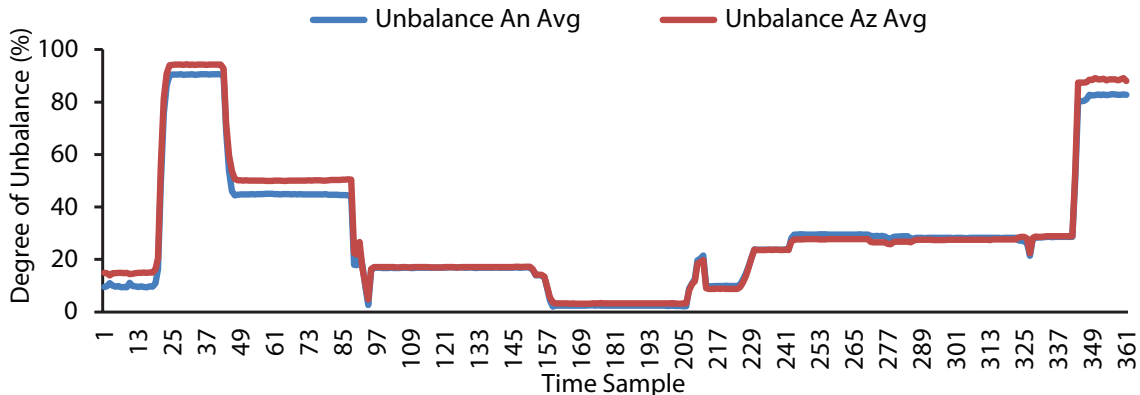

Figure 27: Variation in degree of unbalance with time for BRPL on-site study

Voltage harmonics: Voltage THD values for the phase to neutral voltages were found to be very low (<0.07%) and within the standard limits for THD specified under the IEEE 519 standard (i.e. <8%). Individual voltage harmonics for all three phases are within the IEEE 519 limits (<5%) and it is slightly higher (particularly 5th & 7th harmonics are up to 1.5%) for phase B & C as compared to phase A.

Current harmonics: Maximum value of current THD in phase-C was observed to be approximately 10% when power flowing through this phase was below 2.2-2.3 kW. The 3rd and 5th order harmonics were prominent. The peak value of the harmonic distortion for the 3rd order current harmonic of phases A, B, and C were found to be 25%, 8% and 10% respectively whereas for 5th order, the values were of the order of magnitude around 5%, as shown in figure 28.

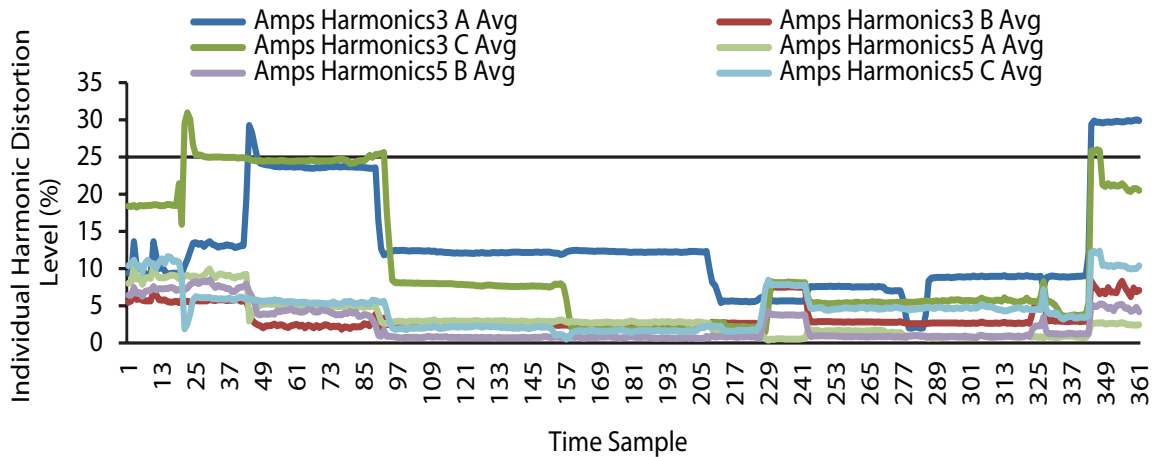

Figure 28: Variation in 3rd and 5th order current harmonic distortion at different instants for BRPL on-site study

4.5.2 Measurement & analysis of EV chargers installed at NDMC HQ, Palika Kendra in New Delhi

Methodology & observations

The Fluke make power quality analyzer was used for PQ parameters recording and assessment purpose. The measurements were done during afternoon time of a typical day in the month of March 2018. The data was logged in the meter for 20 minutes with 10 second interval time (123 samples). Four vehicles were connected to the charger - 3 nos. of Mahindra e-Verito and 1 Tata Tigor. Out of these four, two each were connected to phase A and B respectively while another two were connected to phase C. Three vehicles were being charged through slow chargers whereas one vehicle was getting charged through DC fast charger.

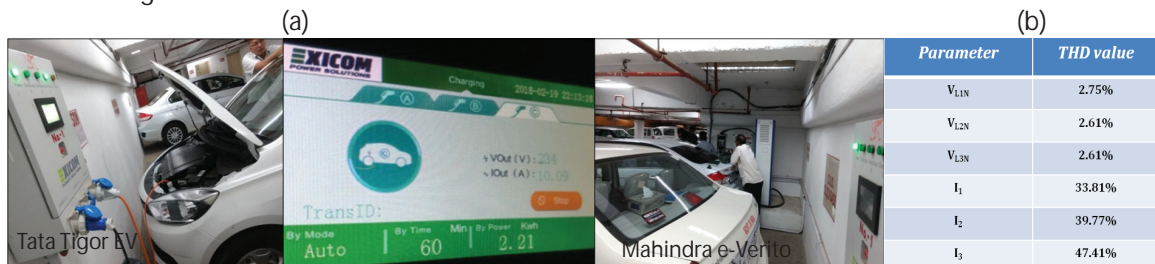

Figure 29: (a) EV charging station at NDMC, New Delhi (b) PQ parameters obtained from on-site measurements

All measurements were captured upto 13th harmonic order for each current and voltage waveform. The values of critical PQ parameters are shown in figure 29 and voltage THD are perceived to be under limit (i.e., <8%) however current THD are found to be crossing the specified limit (i.e., <15%).

4.5.3 Measurement & analysis of EV chargers installed at Kasba Bus Depot under WBTC in Kolkata, West Bengal

One DC fast chargers with two guns (DCFC) and six DC slow chargers, having power ratings of 120 kW and 60 kW respectively, are installed in Kasba bus depot under WBTC. The EV chargers are utilized to charge

the two categories of electric buses (10 nos.), having length of 12 meter and 9 meter respectively. The e-bus models with 12-meter length have battery capacities of 300 kWh and it takes around 1.5 hour to charge from 20% to 100 % state of charge (SoC), whereas slow charger takes 2.5-3 hours to charge the same capacity.

Charger specifications

Table 21: AC & DC Chargers specification at Kasba bus depot, Kolkata

Parameters	DC fast charger	DC slow charger
AC input voltage/frequency	3*415 V +/- 15 %, 50 Hz +/-10 %	3*415 V +/- 15 %, 50 Hz +/-10 %
Number of phases	3 P+N+PE	3 P+N+PE
DC output voltage	200-750 V	200-750 V
DC output current	0-160 A	0-80 A
Rated power	120 kW	60 kW

The possibilities of charging of e-buses fleet are summarized below:

- ❖ Overnight charging of buses at depot
- ❖ 6-7 number of buses out for ride in the morning around 7:00-08:00 AM
- ❖ 3-4 e-buses out for ride at 10:00-11:00 AM
- ❖ 2-4 buses out of 6-7 buses (which had gone for ride in the morning) return back from ride at around 01:00-02:00 PM

Approach & methodology

Two international-make power quality meters (HT Italia, Model no.-PQA 824 and Fluke-435 II) had been connected at distribution meters (ACDB-1, 2 & 3) of EV chargers, having three-phase four-wire configuration as depicted in figure 30 (b). The measurements were taken for 24 hours duration with an interval of 30 seconds. One of the meters (Flukes) was connected at meter-I which supplies power to DCFC only. Similarly, second power analyzer (HT Italia) was connected at meter-II, utilized to supply power for 3 slow chargers (DCSC-1, 2 & 3) as indicated in figure30 (b).

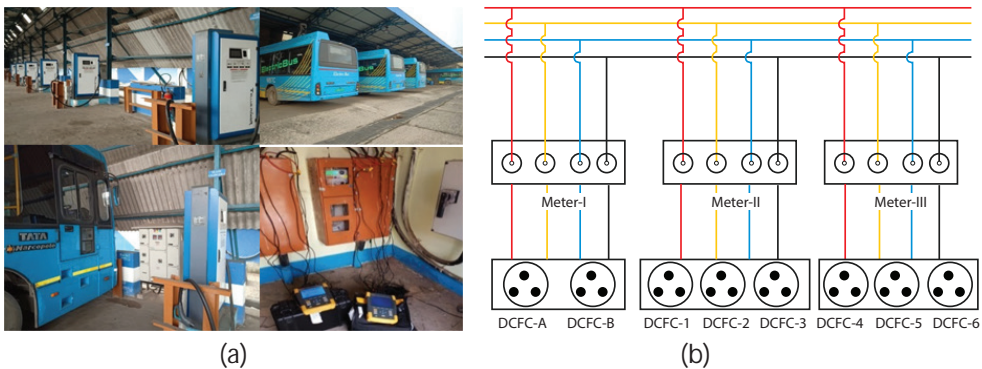

Figure 30: (a) e-buses charging station in Kasba depot (b) Schematic diagram of facility providing power supply to EV chargers

4.5.4 Observation(s) of DCFC (Steady state analysis for 24 hours measurement)

The power flow through each phase is depicted in figure 31 which indicates the scenarios where e-buses fleet are getting charged at DCFC charging point. The DCFC has two charging guns each with rating of 60 kW and therefore it draws 120 kW of power in case two vehicles are being charged at the same time. It is also perceived that power flow through the chargers is significantly reduced when the battery's state of charge is more than 75%. It is perceived that EV chargers are following the constant current & constant voltage type charging topology. Additionally, the current reduced up to 5 to 7 times to maintain the constant DC voltage of EV's battery.

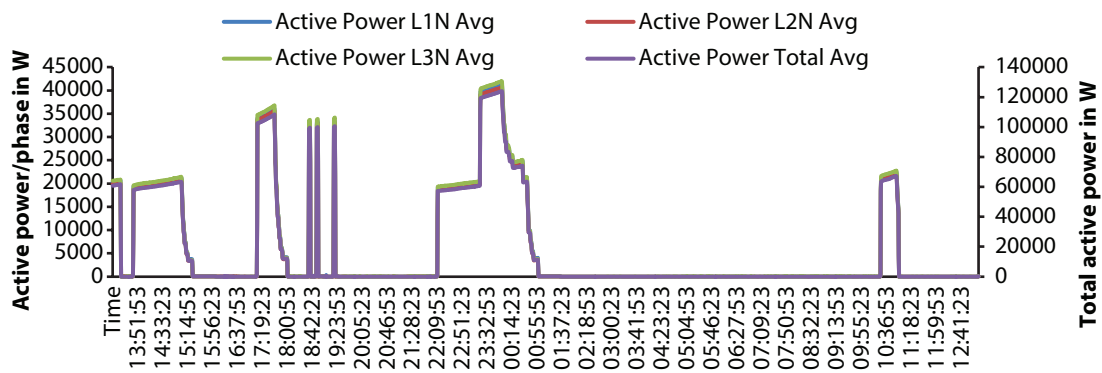

Figure 31: Variation in per phase power in different time slots at Kasba depot

Voltage & current harmonics: The voltage THD are found to be within standard limit (<2.2%) whereas the current THD are observed to be up to 33% when the current in the phases is very minimal (<1 A) as depicted in figure 32.

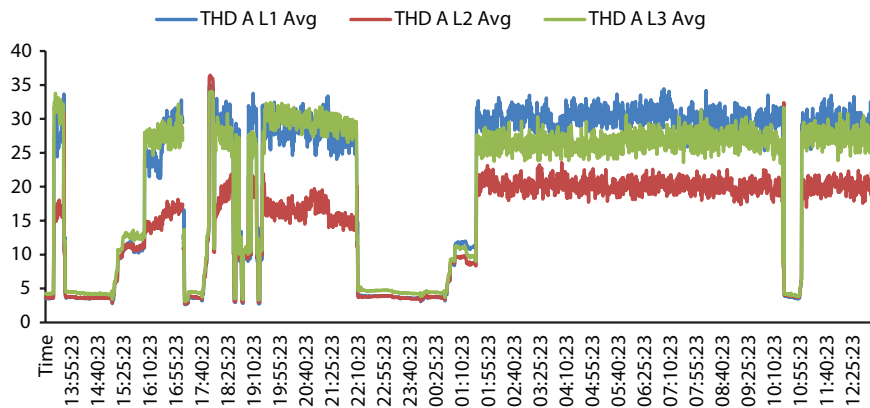

Figure 32: Total harmonic distortion in phase current for Kasba depot measurements

Voltage & current imbalance: The voltage imbalance is found to be within specified limit whereas current unbalance is observed to be out of standard limit (up to 45%) in certain time period as depicted in figure 33, particularly when the current in each phases is considerably low and comparable to neutral current.

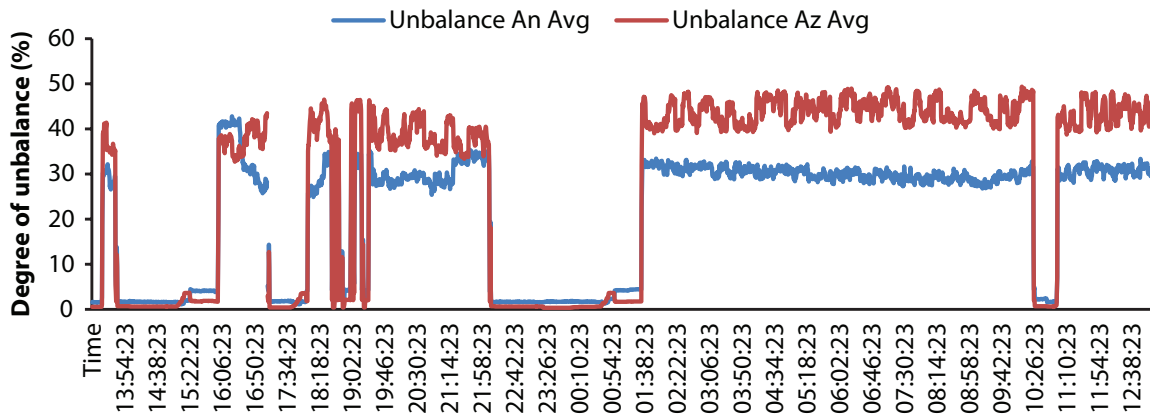

Figure 33: Variation in degree of current unbalance with reference to negative and zero sequence for Kasba depot measurements

4.5.5 Observation(s) of DCSC (Steady state analysis for 24 hours measurement)

Variation in power flow is depicted in figure 34 and it indicates the symmetrical loading on each phase since the DC chargers are having three-phase inbuilt power converters which convert three phase AC power to regulated DC power, thus draws equal current from each phase.

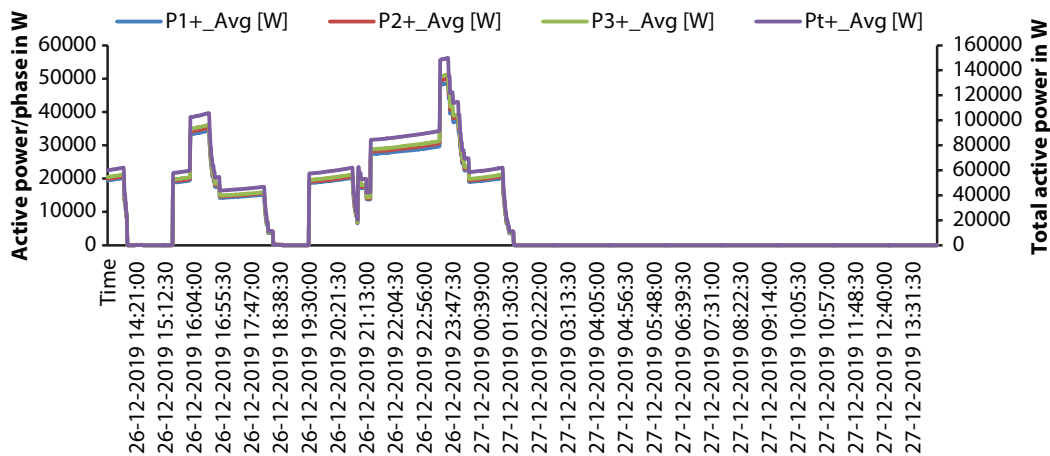

Figure 34: Variation in per phase power in different time slots for Kasba depot measurements

Voltage harmonics: Voltage THD of each phase with respect to neutral wire are found to be under limit as per recommended values in IEEE 519:2014 (i.e.<8%) and the maximum values are observed to be 2%. Individual harmonic components of voltage are also observed to be within specified limit.

Current harmonics: Current THD in each phase is found to be within corresponding limits specified under IEEE 519:2014, especially when the current through the phases is considerably high. However, the values are observed to be on higher side (up to 16%) as depicted in figure 35, particularly when significant amount of current is not flowing through the phases (i.e.< 1 amp.)

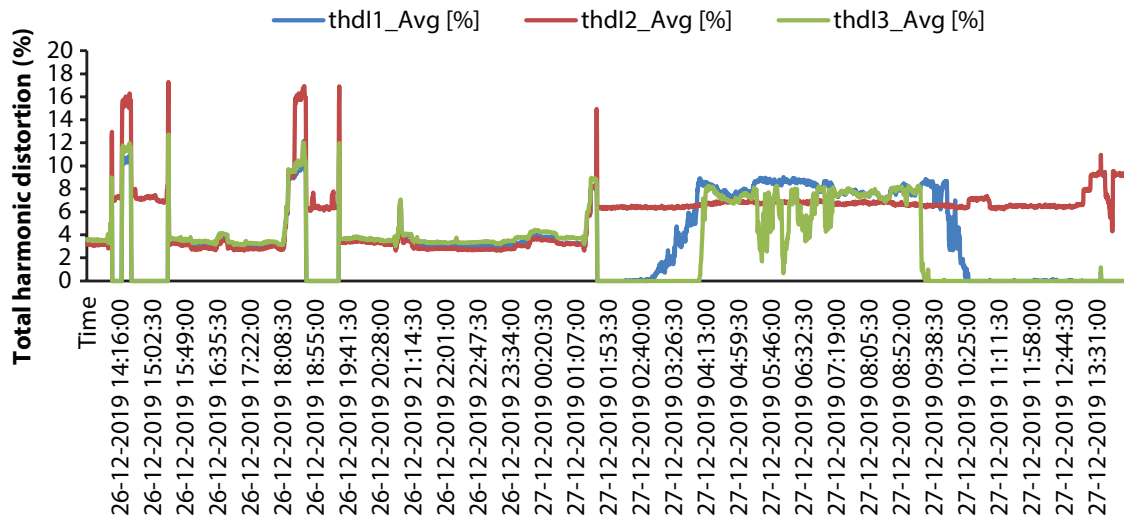

Figure 35: Total harmonic distortion in phase current for Kasba depot measurements

Voltage imbalance: Voltage imbalances with reference to negative and zero sequence are observed to be within corresponding limit specified under ANSI C84.1 and maximum values are observed up to 0.7%.

Harmonics mitigation techniques

The typical classical methodology for harmonic mitigation is being used to avoid high harmonics loads and are represented by AC choke line reactors, K-factor transformers, tuned harmonic filters, low pass harmonic filters, pulse rectifier solutions, phase shifting transformers, transformer connections, active harmonic filters and hybrid harmonic filters. In-addition, passive harmonics filters are being broadly used to avoid the harmonics into supply by providing low impedance path to harmonics current and thereby reducing the distorted current in main supply⁴⁷. It is basically designed to operate at individual frequency to absorb any particular order of harmonics (3rd, 5th, 7th etc.), band of frequency and tuned for series of harmonics. Passive filters are capable of reducing current total harmonic distortion (THD) up to 50 % and also voltage THD_v up to some extent. However, passive filter system has some disadvantages as well which are listed below:

- Not suitable for changing system since it can't be tuned and filter size remain fixed if the filter is designed to operate at specific frequency
- Parallel resonance between grid inductance and filter capacitance may occur if single-tuned passive harmonic filter is off-tuned, thus leads to amplification of source current
- Excessive harmonic currents flow into the passive filter due to the voltage distortion caused by the possible series resonance with the source.

There may be a case where more than one harmonic component is exceeding the specified limit as per IEEE 519:2014. Therefore, it is required to employ a number of shunt filters (passive filter) into the system in order to absorb the multiple order harmonics⁴⁸. However, there is a possibility of resonance occurring due to interaction of filter impedance with source impedance. Hence, the high pass shunt or C-type filter is a preferred option in this case, thereby shunting high orders harmonics above certain level to the ground.

⁴⁷ <https://ieeexplore.ieee.org/document/7905149>

⁴⁸ <https://www.sciencedirect.com/topics/engineering/harmonic-filter>

5. RECOMMENDATIONS & WAY FORWARD

Recommendations

- ❖ Locational planning of EV charging infrastructure is essential for better utilization of electricity distribution network.
- ❖ Smart meters may be made mandatory while granting connectivity to the EV charging stations in-order to implement ToD/ ToU tariff in future. However, support from the Government would be required to develop entire AMI and other backend infrastructure.
- ❖ Separate connection agreement and metering arrangement may be required for housing societies to fall under EV tariff category.
- ❖ Technical impact studies on power quality (PQ), voltage imbalance, etc., are required to be undertaken.
- ❖ DISCOMs are best placed to act as 'Nodal Agency' to implement and manage EV charging infrastructure within their respective license areas.
- ❖ RE-based EV charging option may be encouraged along with necessity of energy storage in selected locations for better grid management, and tariff can be structured such that users are incentivized to charge the vehicle during off-peak and RE/ solar hours.
- ❖ Battery swapping could be allowed as one of the EV charging mechanisms, and battery swapping stations may be made eligible to avail EV charging tariff category.
- ❖ Initially, investment made by the DISCOMs in EV charging infrastructure could be pass-through in their respective ARRs and approved by the concerned SERCs. This may be allowed for initial years until there is a basic EV charging eco-system and such business becomes commercially viable for private-sector investments.
- ❖ In near-term, various grid flexibility services such as smart charging, V2G, etc. may also be explored.
- ❖ Mass-scale campaign and capacity building programme on Electric Vehicles could be initiated by BEE, the 'Central Nodal Agency'.
- ❖ Oil Marketing Companies may be allowed to avail EV tariff category for their EV charging stations in their existing fuel outlets, and DISCOMs may take care of backend electrical infrastructure for an initial time period.
- ❖ Public EV charging stations may be given an RPO target, and allowed 'Open-Access' to source electricity from renewables for less than 1MW of contract load per charging station (distributed within the same licensee area), with cumulative capacity of more than 1MW.
- ❖ End-user's service charge may be decided by the respective 'State Nodal Agency' keeping-in mind commercial viability of public charging stations both for subsidized and non-subsidized EV charging infrastructure.

- ❖ CEA may maintain a data-base of all public charging stations and a universal app may be developed to track availability of chargers in real-time.

Way forward

- ❖ BEE may launch consumers' awareness campaigns and capacity building programmes both at National and State-level under its 'Go-Electric' initiative.
- ❖ State-level EV policies may address aforementioned concerns of relevant stakeholders.
- ❖ EV tariff may be structured in a way to incentivize consumers for peak and off-peak hours charging as well as keeping in-mind DISCOMs' concern regarding purchasing peak power from exchange.
- ❖ Technical assistance may be provided to the interested DISCOMs for planning and installation of EV charging infrastructure within their licensee area.

LIST OF MAJOR REFERENCES

1. Akshay Ahuja, Bindeshwary Rai, Girish Ghatikar, Ravi Seethapathy, Reena Suri and Reji Pillai, "Implementation Plan for Electrification of Public Transportation in Kolkata", ISGF technical report, 2017.
2. Bureau of Energy Efficiency and Ernst & Young. Propelling Electric Vehicles in India: Technical study of Electric Vehicles and Charging Infrastructure. Technical report. 2019.
3. C.R. Atla, S. Muhiuddeen, S. Narayana, Hemanth M., R. Bagdia, S. Mishra, J. Gaebler, I. Mitra and D. Sharma, "Impact assessment of large-scale integration of Electric Vehicle charging infrastructure in the electricity distribution system", 2nd International Conference on Large-Scale Integration of Renewable Energy in India, New Delhi, September 2019.
4. Forum of Regulators. Study on Impact of Electric Vehicles on the Grid. Technical Report. September 2017.
5. IIT Madras and WRI India. A Guidance Document on Accelerating Electric Mobility in India. October 2019.
6. NITI Aayog and Rocky Mountain Institute. India's Electric Mobility Transformation. Technical Report. April 2019.
7. Nitish Arora and Aishwarya Raman, "Beyond Nagpur: The Promise of Electric Mobility - Lessons from India's first Multi-Model E-mobility Project", OLA Mobility Institute report, 2019.
8. P.C. Bhagwat, S.Y. Hadush and S.R.K. Bhagwat, "Charging up India's Electric Vehicles: Infrastructure deployment & power system integration", Report by European University Institute, Robert Schuman Centre for Advanced Studies and the Florence School of Regulation, 2019.
9. Prof. Ankush Sharma, Aastha Kapoor and Prof. Saikat Chakrabarti, "Impact of Plug-in Electric Vehicles on Power Distribution System of Major Cities of India: A Case Study", IIT Kanpur report, August 2019.
10. Reji Kumar Pillai, Reena Suri, Shreekant Dhuri and Suddhasatta Kundu, "Electric Vehicle Policies and Electricity Tariff for EV Charging in India", ISGF study report, July 2019.

ANNEXURES

Annexure 1: List of the DISCOMs as well as Other Key Stakeholders (participated during the interactions)

S. No.	DISCOM
Eastern Region	
1.	CESC
2.	WBSEDCL
Western Region	
1.	MSEDCL
2.	GEDA/ GUVNL
Northern Region	
1.	BRPL
2.	BYPL
3.	NDMC
4.	TPDDL
5.	UPCL
6.	JVVNL
Southern Region	
1.	KSEB
2.	BESCOM
Central Region	
1.	MPCZ/ MPPMCL
S. No.	Other Key Stakeholders
Central Agencies/ Nodal Ministries	
1.	EESL
2.	MoP/ BEE
OMCs	
1.	IOCL
2.	HPCL
CPOs	
1.	Fortum
OEMs	
1.	Mahindra Electric
2.	Delta Electronics
Cab Aggregators	
1.	OLA Electric

Annexure 2: Questionnaire for DISCOMs

Technical/ Operational Aspects

1. How you will identify suitable nodes within your existing electricity distribution network where EV Charging Station (EVCS) can be set-up initially, so that it doesn't affect the voltage profile of the network? Or, how do you identify those nodes?
2. What do you think about importance of communication infrastructure and grid interactive EV Charging Infrastructure (EVCI) through Smart Energy Meters/ AMI?
3. What all challenges you envisage in the context of connection agreements/ connectivity regulations for providing connectivity to home charging, or a public charging station?
4. Do you face or, foresee any voltage fluctuation, phase imbalance, harmonics, and power quality issues in your network due to current/ future EV penetration?
5. Should DISCOMs be the nodal agency (in respective state, public or privately owned) for giving approvals for setting up EVCS in their licensee area?
6. Do you have any plan for grid infrastructure augmentation in-order to accommodate the increased load due to EVCI?
7. How do you plan to identify and evaluate major technical challenges with integrating large share of EVCI in the distribution system, and appropriate mitigation measures?
8. Does the DISCOM need to separately meter EV charging station at home or, other premises, under new tariff category for EV charging (if applicable, in the respective Tariff Order)?
9. What all parameters you may like to consider in-order to identify suitable locations to set up the public EV charging infrastructure, any plan for locational planning study (covering grid aspects & transport planning) for EVCS?
10. Uncoordinated EV charging may cause excessive voltage drops in heavily loaded lines, particularly in long radial networks. So how do you plan to predict uncontrolled EV charging load in the grid? Are you using a load prediction tool or, plan to?
11. Do you plan for using any Machine Learning (ML)/ AI-based techniques for load prediction in future for managing your network?
12. How do you plan to integrate RE-base power into the EVCS network, and what point? What all likely challenges do you think you will face in doing this?
13. Do you believe flexibility potential of EVs through Vehicle-to-X (Vehicle-to-Grid or, Vehicle-to-Household services) capabilities?

Financial/ Investment Aspects

1. What do you think is the best way to manage the EV charging load like implementation of ToD/ ToU/ dynamic pricing are more important or, investment in additional capacity to accommodate EV loads? Are we also exploring for non-wire alternatives such as battery storage etc.?
2. Which business models can be fostered to reach adequate coverage of charging infrastructure network and improve the convenience for EV users?

3. What do you feel would be the impact on Tariff due to Distribution utility's investment into public charging infrastructure for EVs within its licensee area?

Regulatory/ Policy Aspects

1. The additional cost borne by the DISCOMs are peripheral to the adoption of EVs. What could be the provisions for increased cost of power procurement (keeping in-mind crossed subsidized tariff structure) by DISCOM during peak-hours for EV charging?
2. As grid infrastructure should keep pace with the rate of EV adoptions so for major technological transformation, do you think about suitable financial provisions (ARR pass-through) for DISCOMs to augment the grid network?
3. If regulatory approval seems difficult for seeking investment in EV charging infrastructure then what type of revenue/ business models (learnings from global best practices) do you plan?

Annexure 3: Questionnaire for Other Stakeholders

Mahindra Electric

1. As per your experience and future plan, how do you foresee battery capacities (also kind of driving ranges in Indian context) increase for EVs (in short-term) in different vehicle categories?
2. As per your experience and market forecasting, what will be the anticipated EV price-trend in coming years?
3. Estimation (as per your market assessment and understanding) of future EV penetration by drawing analogy to growth in CNG vehicles.

Delta Electronics

1. What kind of business/ ownership models you have adopted so far for implementation of EVCI (both in India & abroad)?
2. What kind of charging standard you prefer?
3. What do you thinking, battery swapping option is economic or feasible?
4. What should be appropriate tariff for charging stations from end user and what could be the role of DISCOMs?
5. Do you think for smart charging technology and V2G technology in India?
6. How do you plan for integrating renewable to the EV charging station? What all likely challenges do you face?
7. Any recommendations on tariff and regulatory incentives?

Fortum

1. What kind of business/ ownership models you have adopted so far for implementation of EVCI (both in India & abroad)?
2. How your charging stations operate (payment method etc.), and what kind of Tariff been charged from end-customers?
3. What type of charging you prefer, fast charging or, slow charging or, mix of both?
4. What do you thinking, battery swapping option is economic or feasible?

IOCL/HPCL

1. Any amendment under PESO/ Petroleum Rules, 2002 in-order to accommodate EV charging stations?
2. What is you short-term & long-term plan for implementation of EV charging stations at the COCO outlets as well as other private fuel retails, located within the city as well in the highways?
3. Have you envisaged issues related with adequate power infrastructure for your fuels stations in-order to cater EV charging load?

EESL

1. What are the operational issues/ challenges faced by you while implementing EVCI?
2. What kind of business/ ownership models you have adopted so far?
3. As per your experience, what will be the price trend (in short-term) for EVs, batteries and chargers etc.?

MoP

1. How DISCOMs will recover the cost for investing into distribution assets due to EV charging?
2. Is there any plan to provide grants to DISCOMs for installing EVChs, other than subsidy available for chargers under FAME-II?
3. Will you allow/ introduce ToU tariff and flexibility functions using V2X technologies?
4. What is your opinion for inclusion of the battery swapping model of charging under the FAME-II scheme?

OLA

1. What are the operational issues/ challenges faced by you while implementing EVCI?
2. What are the tariff related and other regulatory issues in order to implement EVCI?
3. How do you think battery swapping option is feasible or not?

Annexure 4: Case-study for RE plus battery storage based EV Charging

Powering the electric vehicles by renewable energy (solar PV system) ensures the cost-efficient and emission free transportation, thereby charging cost will be much lesser as compare to coal generated power. Under this section, the analysis is focused on how locally produced RE/ solar power along-with BESS will help a STU as well as the DISCOM. In case of Kolkata, the West Bengal Transport Corporation (WBTC) has already procured 80 electric buses which are operational in the city. A depot located at Kasba region under WBTC having 10 numbers of e-buses (12 meter & 9 meter length), has been selected for analysis. An analytical study has been performed for Kasba depot (under CESC licensee area), assessing impact of solar PV and battery energy storage system (BESS) on electricity bill and reduction in operating cost. The objective of the study or, this proposed model is to envisage the monetary benefit to the consumer, herein WBTC by powering the EV chargers through clean source of energy such as solar PV and BESS, thus reduces the energy import from the grid. Therefore, the study will further encourage such commercial consumers to adopt the cleaner and cheaper way of powering the e-buses since the charging/ operating cost will be significantly reduced due to negligible cost of generation of PV systems. However, the optimal size of rooftop solar (RTS)& battery storage need to be evaluated in order to minimize the capital cost, particularly due to higher cost of BESS at present.

Approach/ Methodology

- ❖ Analysed the DT loading data available from July 19 to Jan20 at an interval of 30 minutes (from CESC). The DT (rating-415 kVA) is dedicated to supply the power to EV chargers.
- ❖ Calculated the daily energy bills for 10 maximum energy consuming days and sequentially estimated the average annual bill based on the 10 day's bill (without solar & BESS)
- ❖ Evaluated the RTS potential by analysing the space available over the teen-shade using GIS mapping as shown in figure I (a).
- ❖ RTS potential in the depot are projected to be 145 kWp along-side yearly generation pattern as per Helio-scope analysis.



Figure I: (a) GIS estimation of RTPV potential in bus depot (b) Electric buses getting charged in the depot

- ❖ Annual monetary benefits to the consumers are estimated for both optional Time of day tariff (ToD) & existing tariff schemes (as per CESC's Tariff Order) under different combinations of solar, battery and aforementioned tariff schemes.
- ❖ Further scope of benefit is analysed with 145 kWp solar PV plus 50 kWh battery energy storage systems (BESS). The charging of battery has been considered through excess generation of solar PV in order to reduce the energy export to the grid, thus minimizes the charging cost. The discharge of BESS has been suggested during peak demand period when the cost of power supply is highest in case consumer is opted for ToD tariff scheme.

Outcome:

- ❖ The maximum per day energy consumption is observed to be 1,854 kWh, on 30th August 2019. The month of August, October and November has been the top 10 energy consumption day and therefore these days has been considered in the analysis. The peak loading of DT is observed to be 343.5 kW on October 25, 2019.
- ❖ The average annual benefits to the consumer with solar PV at existing tariff rate @ 8.97 INR/ kWh are projected to be INR 14,86,661, as indicated in figure II (a). Whereas in case consumer is opted for optional tariff scheme (ToD), the benefits are estimated to be INR 9,43,395*, as indicated in figure II (b).

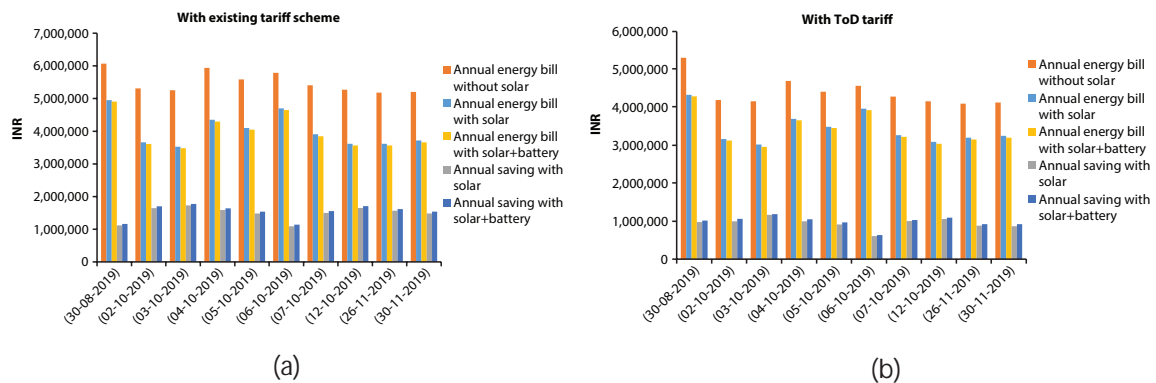

Figure II: (a) Annual savings shown with applicable tariff scheme (b) Annual savings shown with optional tariff scheme

- ❖ The average annual benefit with solar plus battery system at existing tariff rate @ 8.97 INR/ kWh are estimated to be INR 15,39,023. Whereas, the benefits are projected to be INR 9,84,465 with optional tariff scheme (ToD).
- ❖ NPV is estimated considering project life of 10 years with investment of INR 65 Lakhs for solar PV and INR 18 Lakhs for BESS as shown in figure III.

*The margin of benefits due to solar and BESS are seen to be higher with existing tariff scheme since the tariff in the existing scheme is higher than the ToD tariff

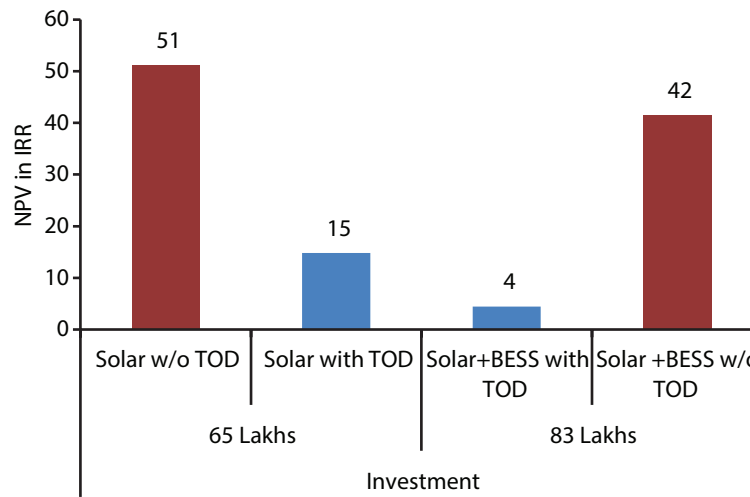

Figure III: Net present values shown with solar plus BESS for different tariff scheme

Following assumptions have been considered to evaluate the net present value of the project:

- ❖ Project Life: 10 Years
- ❖ Discount Factor: 10.72%
- ❖ Loan repayment period is 7 years with capital structure of 70:30
- ❖ Depreciation is taken using SLM with 10% salvage value.
- ❖ O&M is 2% of total project value.
- ❖ Fixed cost includes: ROE, Interest on Loan, Depreciation, O&M, and Interest on working capital.

Annexure 5: DISCOMs investment in PCI: Impact on End-user Tariff and ARR

The rollout of electric vehicles is aided by a concurrent rollout of public charging infrastructure. The government support is essential to initially set up charging infrastructure in order to increase adoption of EVs. This section analyzes the impact on per unit cost in building electric vehicle public charging infrastructure, if the total cost is allowed as pass through in Aggregate Revenue Requirement (ARR) by respective regulatory commission. Consequently, assessing per kilo-meter cost for an end user.

To assess the impact, two distribution utilities were considered—a Delhi based DISCOM and a West Bengal based DISCOM. As per “Charging Infrastructure for EV- guidelines & standards” issued by Ministry of Power (MOP), there must be at least one charging station in a grid of 3 x 3 km² in all megacities and one charging station every 25 km on both sides of highways. Thus, area is assumed as the basis of finding total number of charging stations. Two models of charging infrastructure are assumed for calculation of total capital requirement for deploying charging stations. Forty % (M1) of total charging stations are assumed to have one CCS type and two DC-001 chargers, remaining 60% (M2) of total charging stations are assumed to have three DC-001 chargers.

The total capital expenditure was reckoned making following assumptions:

- ❖ Initial CUF-10% with increase of 10% year-on-year basis for 10 years.
- ❖ Fixed cost components: Interest of Loan, ROE, Depreciation, O&M and Interest on working capital with capital structure of 70:30.
- ❖ Discount Factor: 10.34%
- ❖ Salvage value: 10%.
- ❖ Hours of operation: 18 hours for 365 days.
- ❖ Number of charging stations: Depends on the total area under distribution licensee.
- ❖ M1: Type 2 CCS, Quantity-1, Rating 50kW & DC-001, Quantity-2, Rating 20 kW, 40% of total number of stations.
- ❖ M2: DC-001, Quantity-3, Rating 20 kW, 60% of total number of stations.
- ❖ Cost at which electricity is offered to a charging station: Depends on DISCOM to DISCOM. If a separate category is not provided in tariff orders then average cost of supply is considered.

Cost at which electricity is offered to a charging station by a DISCOM impacts end user tariff as input cost of electricity forms major part of operational expenses for a charging station. For a lower input cost of electricity, end user of the EV is benefitted more for example in case of Delhi (refer figure IV), but the same has to be cross-subsidized leaving negligible impact on other consumers. Government can play crucial role in promoting EVs by establishing initial charging infrastructure. If respective regulatory commissions allow DISCOMs to put charging infrastructure cost as pass through in their ARR, this will have negligible impact of approximately 1 paisa per unit (refer figure V).

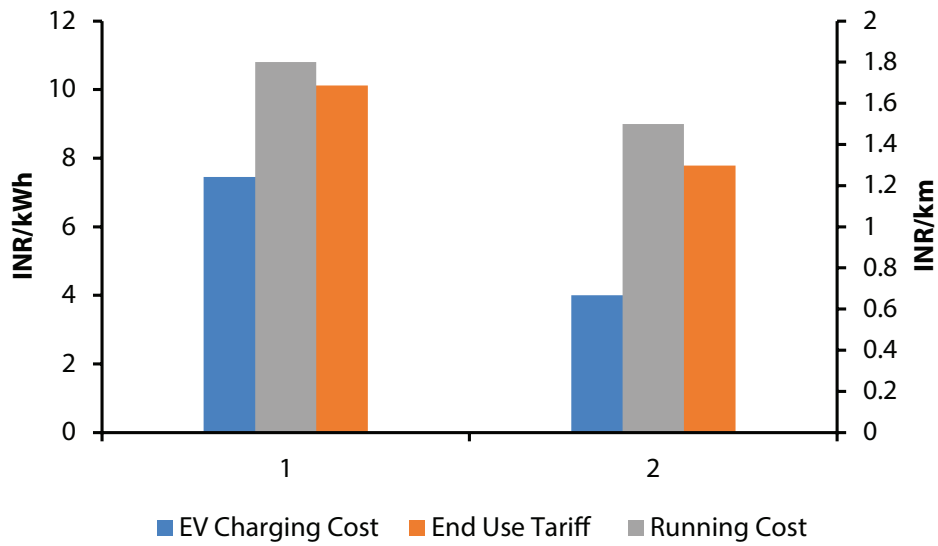

Figure IV: Impact on end-user tariff

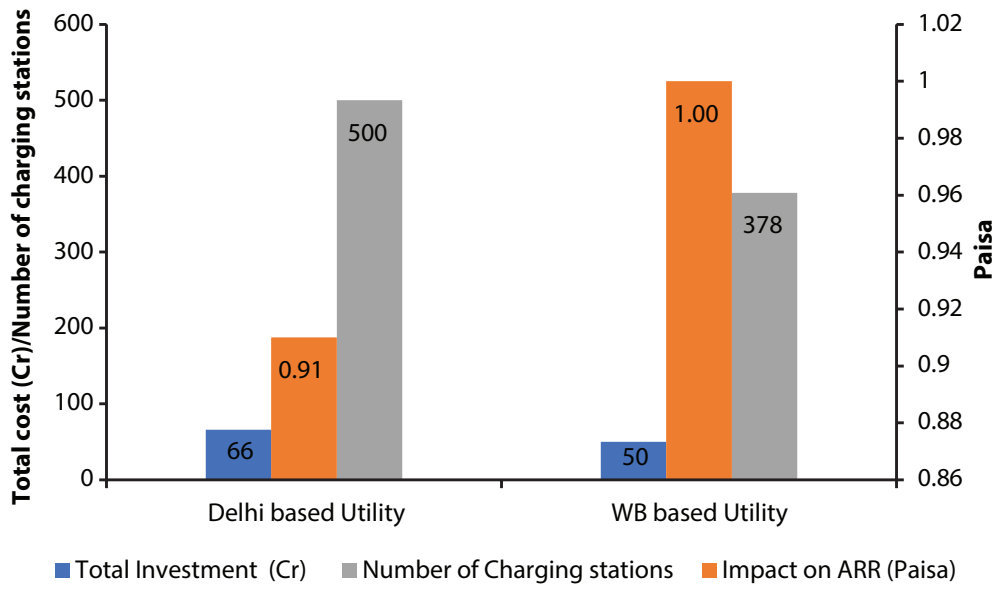
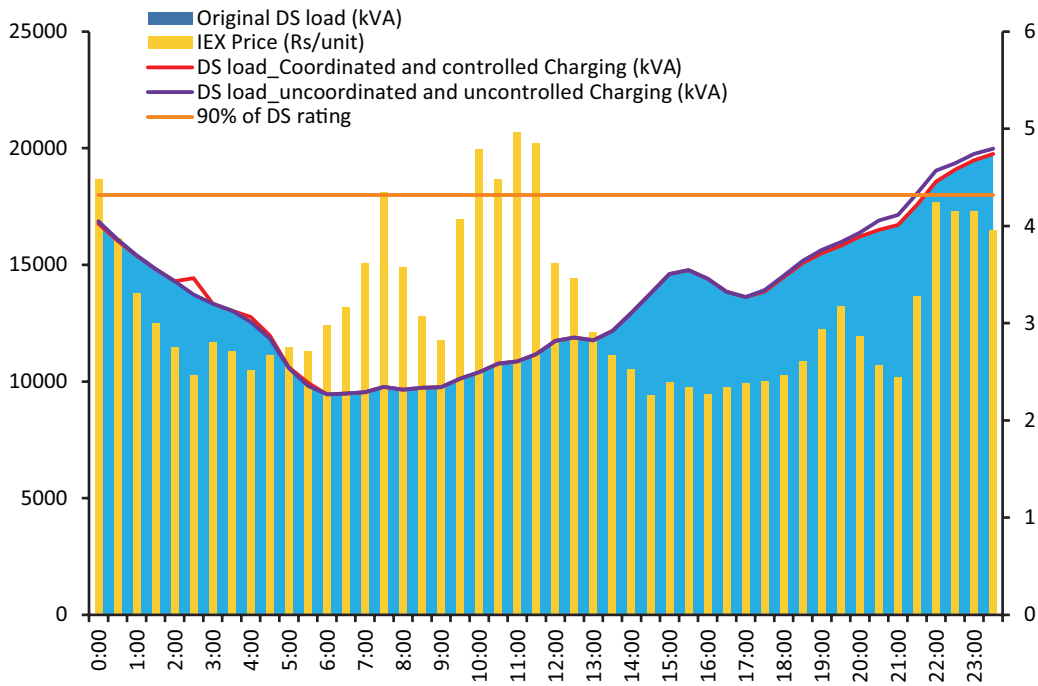

Figure V: Impact on ARR

Annexure 6: Smart Charging Scheme: Results & Observations for Scenario 2

Impact on Distribution Substation (DS) load



Impact on Distribution Transformer (DTs) load

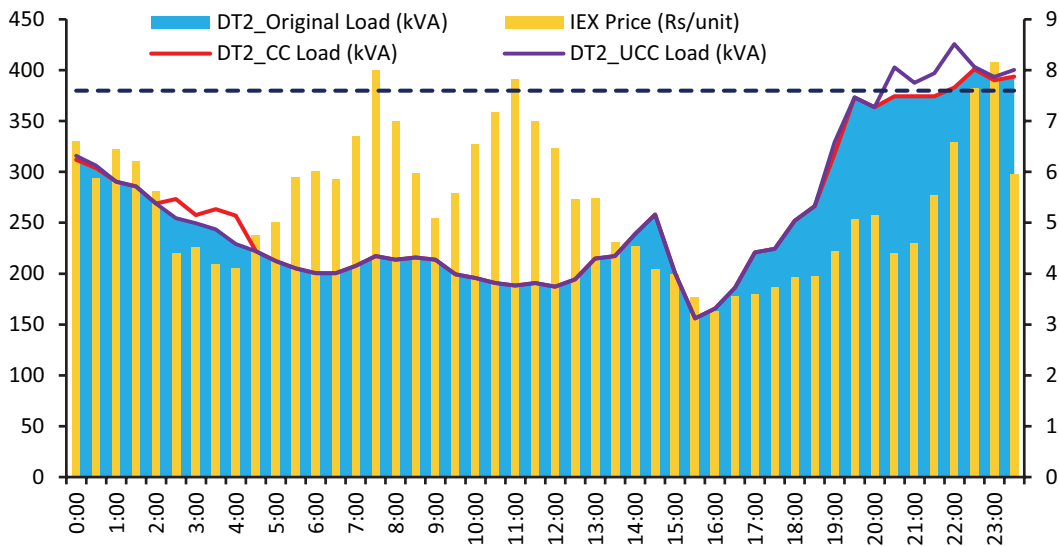

Impact on Power Purchase cost

